

TM 9-808

TM 9-808

WAR DEPARTMENT TECHNICAL MANUAL

RESCINDED Per DA Circular # 310-64, MAY 15 1944

$\frac{3}{4}$ -TON 4 x 4 TRUCK (DODGE)

DECLASSIFIED
Auth: MND 775128
By NNHP MARS 3-3-78

This record was previously
allocated to RG 319 (Entry
No. 382) and is now assigned
to RG 287.

WAR DEPARTMENT

31 JANUARY 1944

WAR DEPARTMENT TECHNICAL MANUAL

TM 9-808

**$\frac{3}{4}$ -TON 4 x 4 TRUCK
(DODGE)**



*WAR DEPARTMENT
31 January 1944*

**This manual supersedes TM 9-808, 12 May 1943, and includes pertinent information from TB 700-1, 1 January 1942; TB 700-20, 13 October 1942; TB 700-33, 11 February 1943; TB 700-37, 4 March 1943; TB 700-43, 17 April 1943; TB 800-4, 29 December 1942, and OFSB 6-11, 1 November 1943. For the supersession of Quartermaster Corps (10-series) manuals see paragraph 1 d.*

9 030911

PROPERTY OF U.S. ARMY

WAR DEPARTMENT
Washington 25, D. C., 31 January 1944

TM 9-808, 3/4-ton 4 x 4 Truck (Dodge), is published for the information and guidance of all concerned

[A.G. 300.7 (20 Oct. 43)]

BY ORDER OF THE SECRETARY OF WAR:

G. C. MARSHALL,
Chief of Staff.

OFFICIAL:

A. ULIO,
Major General,
The Adjutant General.

DISTRIBUTION: B and H (5); B18 (2); R9 (4); Bn 6, 7, 9 and 18 (2); Cg, 7 and 18 (2), 9 (5).

(For explanation of symbols, see FM 21-6)

MAY 8 1944

Property of U. S.

3/4-TON 4 x 4 TRUCK (DODGE)

CONTENTS

PART ONE—VEHICLE OPERATING INSTRUCTIONS

SECTION		Paragraphs	Pages
I	Introduction	1	5
II	Description and tabulated data ..	2-4	6-14
III	Driving controls and operation ..	5-9	15-33
IV	Auxiliary equipment controls and operation	10-11	34-38
V	Operation under unusual conditions	12-17	39-46
VI	First echelon preventive maintenance services	18-22	47-56
VII	Lubrication	23-24	57-67
VIII	Tools and equipment stowage on the vehicle	25	68-69

PART TWO—VEHICLE MAINTENANCE INSTRUCTIONS

SECTION IX	Record of modifications	26	70
X	New vehicle run-in test	27-28	71-75
XI	Second echelon preventive maintenance	29	76-97
XII	Organization tools and equipment	30-31	98
XIII	Trouble shooting	32-53	99-132
XIV	Engine—description, maintenance, and adjustment in vehicle	54-65	133-153
XV	Engine removal and installation	66-67	154-162
XVI	Fuel system	68-75	163-176
XVII	Exhaust system	76-79	177-178
XVIII	Cooling system	80-86	179-189
XIX	Battery	87-89	190-194

3/4-TON 4 x 4 TRUCK (DODGE)

	Paragraphs	Pages
SECTION XX Starting system	90-93	195-197
XXI Generating system	94-97	198-201
XXII Ignition system	98-102	202-208
XXIII Radio interference suppression..	103	209-219
XXIV Lighting system	104-113	220-230
XXV Instruments, gages, and miscel- laneous electrical equipment..	114-123	231-240
XXVI Wiring	124-128	241-251
XXVII Clutch	129-131	252-255
XXVIII Transmission and power take-off.	132-134	256-261
XXIX Transfer case	135-137	262-264
XXX Propeller shafts	138-139	265-267
XXXI Front axle	140-145	268-280
XXXII Rear axle	146-149	281-286
XXXIII Foot brakes	150-155	287-297
XXXIV Hand brake	156-160	298-302
XXXV Wheels and tires	161-165	303-309
XXXVI Steering	166-169	310-315
XXXVII Frame	170-171	316-318
XXXVIII Springs and shock absorbers	172-176	319-325
XXXIX Body and sheet metal	177-187	326-333
XL Winch	188-193	334-337

PART THREE—STORAGE AND SHIPMENT

SECTION XLI Storage and shipment	194-198	338-343
REFERENCES		344-346
INDEX		347

PART ONE—VEHICLE OPERATING INSTRUCTIONS**Section I****INTRODUCTION**

	Paragraph
Scope	1

1. SCOPE.

a. This technical manual is published for the information and guidance of the using arm personnel charged with the operation and maintenance of this materiel.

b. In addition to a description of the $\frac{3}{4}$ -ton 4 x 4 truck (Dodge), this manual contains technical information required for the identification, use, and care of the materiel. The manual is divided into three parts. Part One, section I through section VIII, contains vehicle operating instructions. Part Two, section IX through section XL, contains vehicle maintenance instructions for using arm personnel charged with the responsibility of doing maintenance work within their jurisdiction. Part Three, section XLI, contains instructions for the shipment and limited storage of this vehicle.

c. In all cases where the nature of the repair, modifications, or adjustment is beyond the scope or facilities of the unit, the responsible ordnance service should be informed so that trained personnel with suitable tools and equipment may be provided, or proper instructions issued.

d. This manual includes operating and organizational maintenance instructions from TM 10-1531, 1 October 1942. Together with TM 9-1808A and TM 9-1808B this manual supersedes TM 10-1531, 1 October 1942.

3/4-TON 4 x 4 TRUCK (DODGE)

Section II-

DESCRIPTION AND TABULATED DATA

	Paragraph
Description	2
Differences among models	3
Data	4

2. DESCRIPTION.

a. The following models of vehicles are covered by this manual:

Type of Vehicle	Model	Type of Vehicle	Model
Weapon carrier	WC-51	Command	WC-56
Weapon carrier with winch	WC-52	Command with winch ..	WC-57
Carryall	WC-53	Telephone maintenance.	WC-59
Ambulance	WC-54	Emergency repair	WC-60

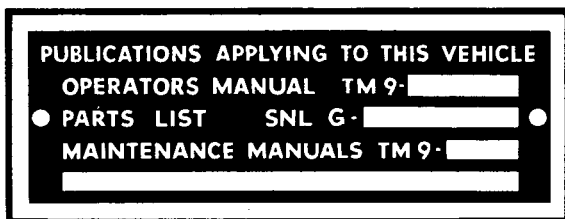

RA PD 52784

Figure 1—Publication Identification Plate

b. All models are equipped with a liquid-cooled, 6-cylinder, L-head gasoline engine, located at the front of the vehicle. Engine power is transmitted from the four-speed transmission through a short propeller shaft to the transfer case, and thence to both front and rear axles. The vehicles may be driven with all four wheels or with rear wheels only.

c. A manual identification plate is attached to the instrument panel of each vehicle to designate the technical manual number and parts list number pertaining to the vehicle (fig. 1).

d. A serial number plate is attached to the instrument panel of each vehicle. This plate gives pertinent vehicle information such as model, serial number, weights, fuel and oil recommendations (fig. 2).

e. The steering gear of all models is mounted on the left side; therefore, all models are known as "left-hand drive" vehicles. Throughout this manual, the use of the terms "left" and "right" indicate positions in relation to the location of the steering gear; "left" means the steering gear side; "right" means the side opposite steering gear.

DESCRIPTION AND TABULATED DATA**3. DIFFERENCES AMONG MODELS.**

a. **Weapon Carrier; Models WC-51 and WC-52** (figs. 3 and 4). The difference between models WC-51 and WC-52 is that the latter is equipped with a power take-off and a drive shaft for the winch mounted at the front of the vehicle. Both models can be identified

DODGE TRUCKS	
DIVISION OF CHRYSLER CORPORATION DETROIT, MICH.	
NOMENCLATURE <input type="text"/>	
MODEL <input type="text"/>	SERIAL NO <input type="text"/>
SUPPLY ARM OR SERVICE MAINTAINING TRUCK	
<input type="text"/>	
GROSS WEIGHT <input type="text"/> LBS.	MAX. PAYLOAD <input type="text"/> LBS.
MAX. TRAILED LOAD <input type="text"/> LBS.	DATE DELIVERY <input type="text"/>
RECOMMENDED OCTANE RATING GASOLINE 70 MIN.	
RECOMMENDED S.A.E. GRADE OIL SUMMER — 30	
RECOMMENDED S.A.E. GRADE OIL WINTER — 10	

RA PD 52710

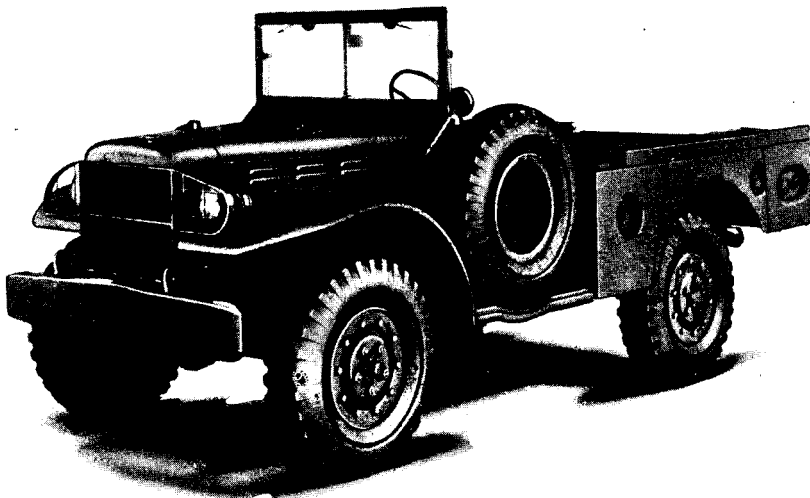
Figure 2—Serial Number Plate

RA PD 52757

Figure 3—Weapon Carrier (Model WC-51)—Left Front View

by the open driver's compartment and weapon carrier body with tarpaulin mounted behind the driver's compartment. The electrical system of both models is 6-volt with the battery located under the hood.

b. **Carryall; Model WC-53** (fig. 5). This model can be identified by its closed body with side windows. The electrical system is 12-volt

3/4-TON 4 x 4 TRUCK (DODGE)

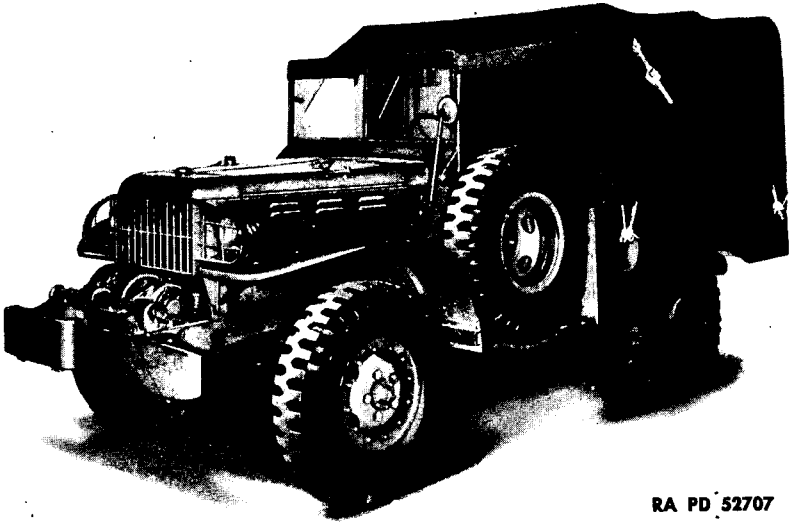

RA PD 52707

**Figure 4—Weapon Carrier (Model WC-52) with Winch—
Left Front View**

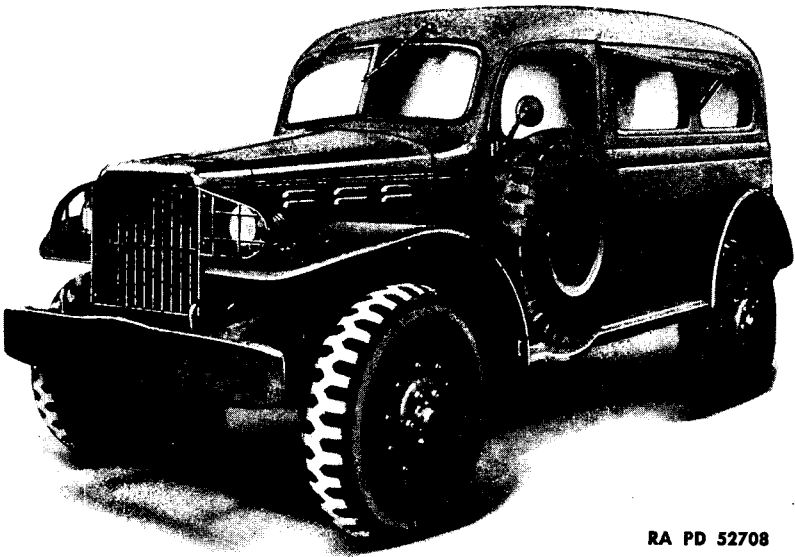

RA PD 52708

Figure 5—Carryall (Model WC-53)—Left Front View

DESCRIPTION AND TABULATED DATA

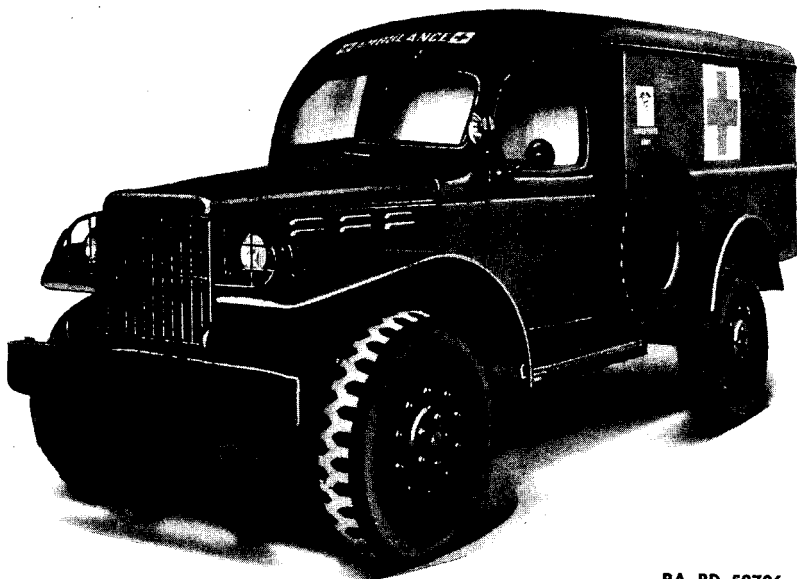

RA PD 52706

Figure 6—Ambulance (Model WC-54)—Left Front View

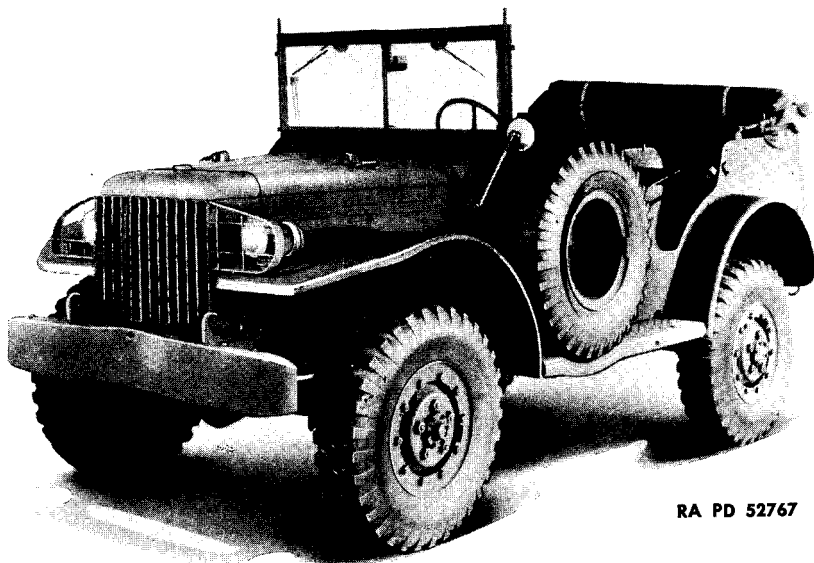

RA PD 52767

Figure 7—Command (Model WC-56)—Left Front View

3/4-TON 4 x 4 TRUCK (DODGE)

with battery located on right running board, and provision is made for the installation of radio equipment.

c. **Ambulance; Model WC-54** (fig. 6). This model can be identified by the large cross on each side of the body. It contains equipment for the care of wounded personnel. The electrical system is 6-volt with battery located under the hood.

d. **Command; Models WC-56 and WC-57** (figs. 7 and 8). The difference between models WC-56 and WC-57 is that the latter is equipped with a power take-off and a drive shaft for the winch mounted at the front of the vehicle. Both models can be identified by the open type body with folding top and side curtains. The elec-

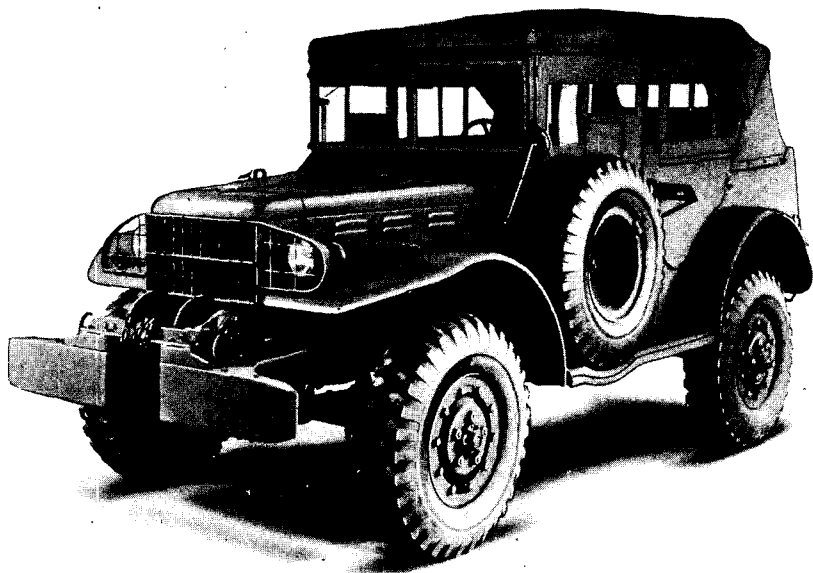

RA PD 52760

Figure 8—Command (Model WC-57) with Winch—Left Front View

trical system of both models is 12-volt with battery located on the right running board and provision is made for the installation of radio equipment behind the front seat.

e. **Telephone Maintenance; Model WC-59** (fig. 9). This model can be identified by its open cab and box-shaped body with extension ladder mounted on the left side. The electrical system is 6-volt with battery located under the hood.

f. **Emergency Repair; Model WC-60** (fig. 10). This vehicle is equipped with a body containing ordnance repair equipment. The electrical system is 6-volt with battery located under the hood.

DESCRIPTION AND TABULATED DATA

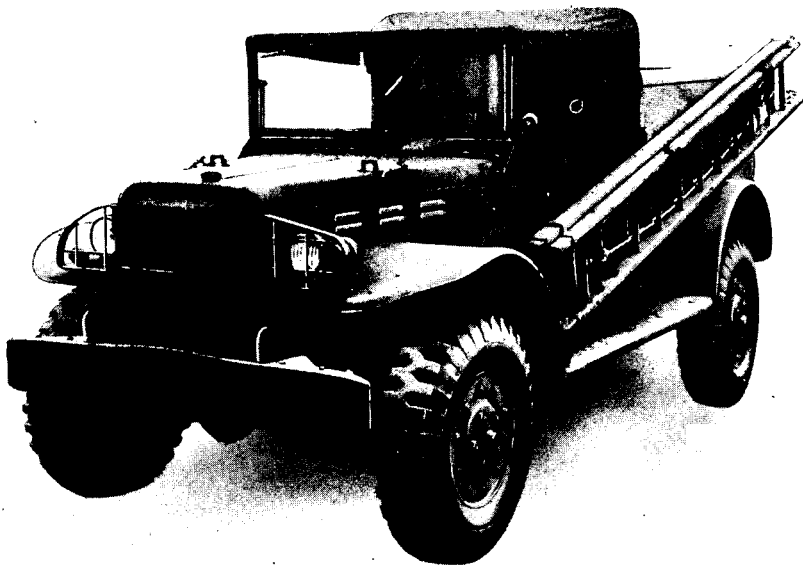

RA PD 52798

**Figure 9—Telephone Maintenance (Model WC-59)—
Left Front View**

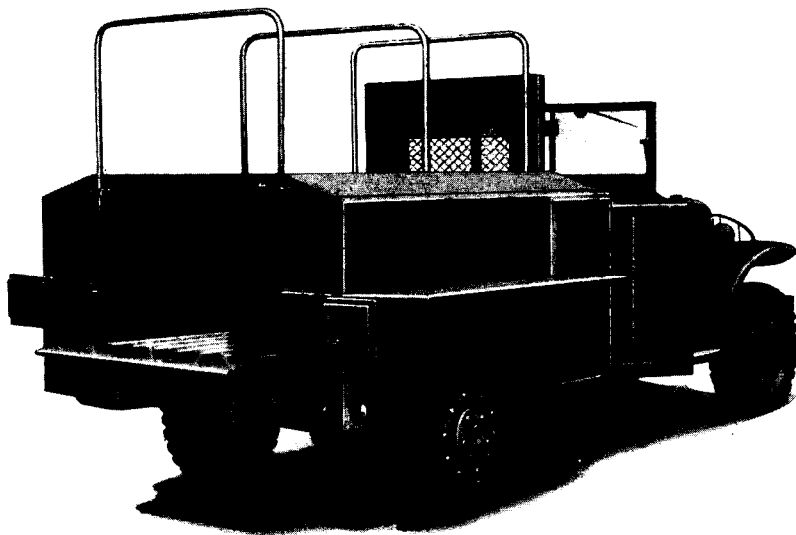

RA PD 52907

Figure 10—Emergency Repair (Model WC-60)—Right Rear View

¾-TON 4 x 4 TRUCK (DODGE)

4. DATA.

a. Vehicle Specifications.

Engine (number of cylinders)	6
Transmission (number of speeds)	4 forward, 1 reverse
Transfer case (number of speeds)	1
Axle ratio (front and rear)	5.83 to 1

Tires:

Size	9.00 x 16 in., 8 ply
Rim size	16 x 6.50 CS

Electrical system voltage:

Weapon carrier, with and without winch	6 to 8 volts
Command, with and without winch	12 to 15 volts
Carryall	12 to 15 volts
Ambulance	6 to 8 volts
Telephone maintenance	6 to 8 volts
Emergency repair	6 to 8 volts

Winch, capacity	5,000 lb
-----------------------	----------

Angle of approach and departure:

	Approach	Departure
Weapon carrier, without winch	54 degrees	31 degrees
Weapon carrier, with winch	37 degrees	31 degrees
Carryall	54 degrees	28 degrees
Ambulance	53 degrees	24 degrees
Command, without winch	54 degrees	31 degrees
Command, with winch	37 degrees	31 degrees
Telephone maintenance	53 degrees	29 degrees
Emergency repair	53 degrees	32 degrees

Weights (road weight of fully equipped vehicle without load or driver):

Weapon carrier, without winch	5,250 lb
Weapon carrier, with winch	5,550 lb
Command, without winch	5,375 lb
Command, with winch	5,675 lb
Carryall	5,750 lb
Ambulance	5,920 lb
Telephone maintenance	5,400 lb
Emergency repair	5,950 lb

Over-all width:

Weapon carrier, with and without winch	82¾ in.
Command, with and without winch	78⅝ in.
Carryall	78⅝ in.
Telephone maintenance	77¾ in.
Emergency repair	81½ in.
Ambulance	77¾ in.

DESCRIPTION AND TABULATED DATA

Tread, front and rear	64 $\frac{3}{4}$ in.
Over-all length:	
Weapon carrier, without winch	166 $\frac{7}{8}$ in.
Weapon carrier, with winch	176 $\frac{1}{2}$ in.
Command, without winch	166 in.
Command, with winch	175 $\frac{5}{8}$ in.
Carryall	185 $\frac{5}{8}$ in.
Ambulance	194 $\frac{1}{2}$ in.
Telephone maintenance	191 $\frac{1}{2}$ in.
Emergency repair	186 in.
Over-all height:	
Weapon carrier, with and without winch	81 $\frac{7}{8}$ in.
Command, with and without winch	81 $\frac{1}{2}$ in.
Carryall	80 $\frac{1}{4}$ in.
Ambulance	90 $\frac{3}{8}$ in.
Telephone maintenance	80 $\frac{3}{4}$ in.
Emergency repair	89 in.
Road clearance, front and rear axle	10 $2\frac{3}{32}$ in.
Turning radius:	
Weapon carrier and command, with and without winch ..	21 ft 2 in.
Carryall	24 ft 6 in.
Ambulance, telephone maintenance, and emergency repair	26 ft 3 in.
b. Performance.	
Brake horsepower (gross)	92 at 3,200 rpm 54.5 at 1,600 rpm
Engine compression pressure at cranking speed	98 to 118 lb
Engine oil pressure	30 to 50 lb above 30 mph
Maximum speed at 3,200 engine revolutions per minute (all models):	
In fourth gear	55 mph
In third gear	33 mph
In second gear	18 mph
In first gear	9 mph
In reverse gear	7 mph
Maximum grade ascending ability (all models) of fully loaded vehicle (1,500 lb allowance for pay load, driver, and assistant driver):	
In transmission low gear	60 pct (approx)
In transmission high gear	7 to 8 pct (approx)
In transmission high gear when towing 1,000-lb load	6 to 7 pct (approx)
Maximum grade descending ability with vehicle fully loaded (all models)	60 pct

3/4-TON 4 x 4 TRUCK (DODGE)

c. Capacities.

Fuel tank	30 gal
Crankcase (refill)	5 qt
Cooling system	17 qt
Transmission	2 ³ / ₄ qt
Transmission, with power take-off	3 ¹ / ₂ qt
Carburetor air cleaner	1 qt
Front and rear axle differentials	2 ¹ / ₄ qt for vehicles with serial numbers up to 81674747 (except serial numbers 81657582 through 81674101).
	3 qt for vehicles with serial numbers after 81657582 (except serial numbers 81674101 through 81674747).
Transfer case	1 ¹ / ₂ qt
Winch worm housing	1 qt

Section III

DRIVING CONTROLS AND OPERATION

	Paragraph
Instruments and controls	5
Preparation of new vehicle for service	6
Use of instruments and controls in vehicular operation	7
Towing the vehicle	8
Body equipment	9

5. INSTRUMENTS AND CONTROLS.

a. **Ignition Switch** (figs. 11 and 12). This switch has two positions, "ON" and "OFF." When turned clockwise ("ON"), the battery is connected with the ignition circuit and the engine may be started. With the switch "ON," the fuel gage registers the amount of fuel in the tank, and the heater, defroster, and roof ventilator, are also operative (if so equipped).

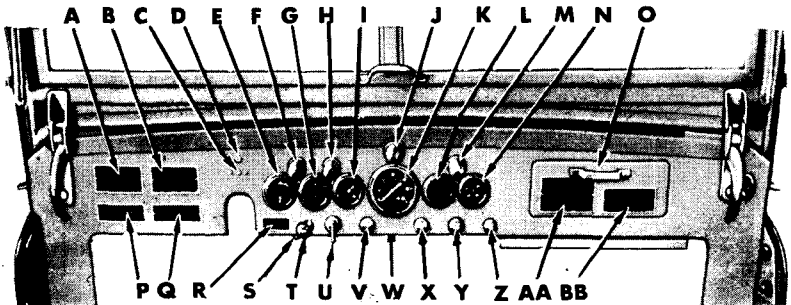

- | | |
|---|---|
| A —COOLING SYSTEM
DRAIN CAUTION PLATE | Q —MANUAL IDENTIFICATION PLATE |
| B —TRANSMISSION AND TRANSFER
CASE SHIFT DIAGRAM PLATE | R —VOLTMETER INSTRUCTION PLATE
(COMMAND) |
| C —VOLTMETER SWITCH (COMMAND) | S —MAIN LIGHTING AND BLACKOUT
SWITCH LOCK |
| D —BEAM INDICATOR | T —MAIN LIGHTING AND
BLACKOUT SWITCH |
| E —VOLTMETER (COMMAND) | U —IGNITION SWITCH |
| F —INSTRUMENT LIGHT | V —CHOKE CONTROL BUTTON |
| G —AMMETER | W —SPEEDOMETER TRIP MILEAGE
SET STEM |
| H —INSTRUMENT LIGHT | X —THROTTLE CONTROL BUTTON |
| I —OIL PRESSURE GAGE | Y —INSTRUMENT LIGHT SWITCH |
| J —INSTRUMENT LIGHT | Z —BLACKOUT DRIVING LIGHT SWITCH |
| K —SPEEDOMETER | AA —SERIAL NUMBER PLATE |
| L —FUEL GAGE | BB —WINCH CAUTION PLATE |
| M —INSTRUMENT LIGHT | |
| N —THERMOMETER | |
| O —PACKAGE COMPARTMENT | |
| P —MAXIMUM PERMISSIBLE
ROAD SPEED CAUTION PLATE | |

RA PD 312544

Figure 11—Instrument Panel (Open Bodies)

3/4-TON 4 x 4 TRUCK (DODGE)

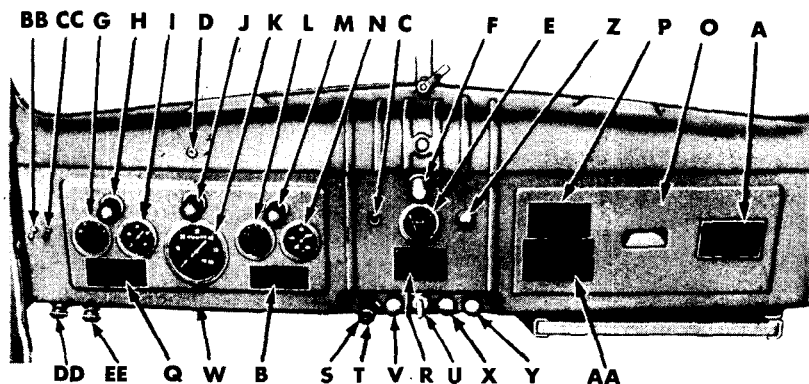

- | | |
|---|--|
| A —COOLING SYSTEM
DRAIN CAUTION PLATE | R —VOLTMETER INSTRUCTION PLATE
(CARRYALL) |
| B —TRANSMISSION AND TRANSFER
CASE SHIFT DIAGRAM PLATE | S —MAIN LIGHTING AND BLACKOUT
SWITCH LOCK |
| C —VOLTMETER SWITCH (CARRYALL) | T —MAIN LIGHTING AND
BLACKOUT SWITCH |
| D —BEAM INDICATOR | U —IGNITION SWITCH |
| E —VOLTMETER (CARRYALL) | V —CHOKE CONTROL BUTTON |
| F —INSTRUMENT LIGHT | W —SPEEDOMETER TRIP MILEAGE
SET STEM |
| G —AMMETER | X —THROTTLE CONTROL BUTTON |
| H —INSTRUMENT LIGHT | Y —INSTRUMENT LIGHT SWITCH |
| I —OIL PRESSURE GAGE | Z —BLACKOUT DRIVING LIGHT SWITCH |
| J —INSTRUMENT LIGHT | AA —SERIAL NUMBER PLATE |
| K —SPEEDOMETER | BB —ROOF VENTILATOR SWITCH
(AMBULANCE) |
| L —FUEL GAGE | CC —DOME LIGHT SWITCH (AMBULANCE) |
| M —INSTRUMENT LIGHT | DD —HEATER DEFROSTER BLOWER
SWITCH (AMBULANCE) |
| N —THERMOMETER | EE —HEATER SWITCH (AMBULANCE) |
| O —PACKAGE COMPARTMENT | |
| P —MAXIMUM PERMISSIBLE
ROAD SPEED CAUTION PLATE | |
| Q —MANUAL IDENTIFICATION PLATE | |

RA PD 312545

Figure 12—Instrument Panel (Closed Bodies)

b. Choke Control Button (figs. 11 and 12). This button controls the fuel mixture for starting the engine when cold.

c. Throttle Control Button (figs. 11 and 12). This button controls the opening and closing of the throttle, which in turn controls engine speed.

d. Accelerator Pedal (figs. 13 and 14). This foot-operated pedal is used to control engine speed while driving the vehicle.

e. Cranking Motor Pedal (figs. 13 and 14). This foot-operated pedal actuates the starting motor for cranking the engine.

f. Clutch Pedal (figs. 13 and 14). When this foot-operated pedal is pressed downward, the clutch is disengaged, and the transmission gears may be shifted with the engine running without danger of

DRIVING CONTROLS AND OPERATION

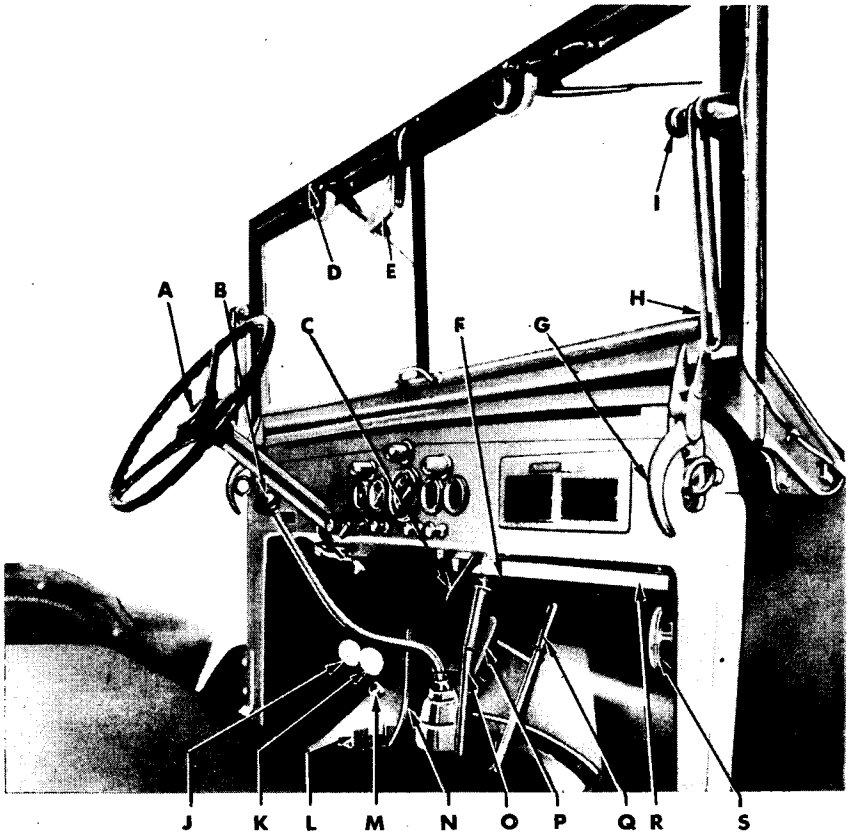

- A—HORN BUTTON
- B—TRANSMISSION GEARSHIFT LEVER
- C—COWL VENTILATOR HANDLE (RATCHET AND BRACE)
- D—WINDSHIELD WIPER CONTROL KNOB
- E—REAR VIEW MIRROR
- F—CRANKING MOTOR PEDAL ROD BUTTON
- G—WINDSHIELD CLAMP HANDLE
- H—WINDSHIELD ADJUSTING ARM
- I—WINDSHIELD ADJUSTING ARM LOCK NUT
- J—CLUTCH PEDAL
- K—BRAKE PEDAL
- L—POWER TAKE-OFF CONTROL LEVER SHIFT LOCK
- M—BEAM CONTROL SWITCH
- N—POWER TAKE-OFF CONTROL LEVER
- O—HAND BRAKE LEVER
- P—ACCELERATOR PEDAL
- Q—TRANSFER CASE HAND LEVER
- R—MAP TABLE BOARD
- S—FIRE EXTINGUISHER

RA PD 318322

Figure 13—Front Compartment (Open Bodies)

3/4-TON 4 x 4 TRUCK (DODGE)

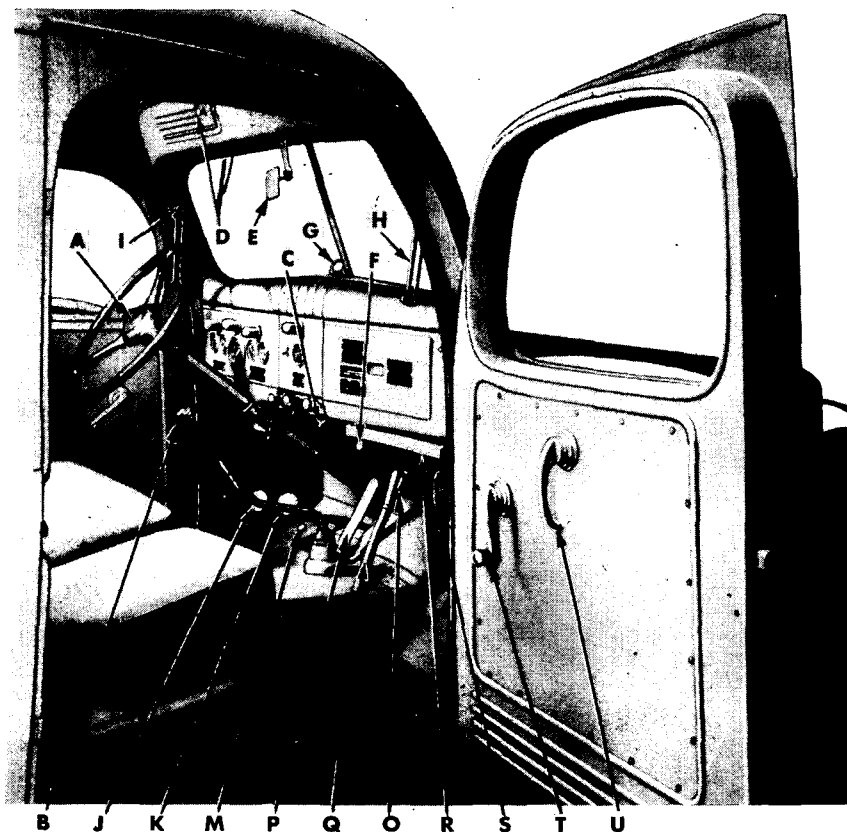

- A—HORN BUTTON
- B—TRANSMISSION GEARSHIFT LEVER
- C—COWL VENTILATOR HANDLE (RATCHET AND BRACE)
- D—WINDSHIELD WIPER CONTROL KNOB
- E—REAR VIEW MIRROR
- F—CRANKING MOTOR PEDAL ROD BUTTON
- G—WINDSHIELD PULL-TO HANDLE
- H—WINDSHIELD ADJUSTING ARM
- I—WINDSHIELD ADJUSTING ARM LOCK NUT
- J—CLUTCH PEDAL
- K—BRAKE PEDAL
- M—BEAM CONTROL SWITCH
- O—HAND BRAKE LEVER
- P—ACCELERATOR PEDAL
- Q—TRANSFER CASE HAND LEVER
- R—MAP TABLE BOARD
- S—FIRE EXTINGUISHER (CARRYALL)
- T—DOOR WINDOW REGULATOR HANDLE
- U—DOOR REMOTE CONTROL HANDLE

RA PD 318323

Figure 14—Front Compartment (Closed Bodies)

DRIVING CONTROLS AND OPERATION

breaking gear teeth in the transmission. When foot pressure on the pedal is relieved, it will return to the engaged position.

g. Transmission Gearshift Lever (figs. 13 and 14). This hand-operated lever may be moved from neutral position to mesh the gears in the transmission for first, second, third, fourth, or reverse speeds.

h. Transfer Case Hand Lever (figs. 13 and 14). This lever may be moved to either of two positions. In its forward position, power is applied only to the rear axle. In its rear position (nearest the seat), power is applied to both front and rear axles for four-wheel driving.

i. Hand Brake Lever (figs. 13 and 14). When this lever is pulled back toward the seat, the hand brake is applied. Use the hand brake lever only for the purpose of holding the vehicle while parked.

j. Brake Pedal (figs. 13 and 14). When this foot-operated pedal is pressed downward, the brakes at each wheel are applied to slow down or stop the vehicle.

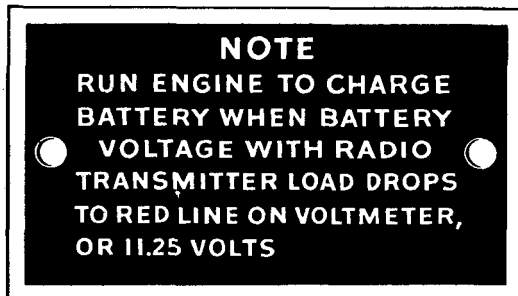

RA PD 52740

Figure 15—Voltmeter Instruction Plate

k. Instruments.

(1) **OIL PRESSURE GAGE** (figs 11 and 12). This gage indicates the pressure under which oil is pumped through the engine oiling system.

(2) **AMMETER** (figs. 11 and 12). This meter shows the amount of electricity flowing into or out of the battery. When the electrical units of the vehicle are using more electricity than the generator is supplying, the pointer of the ammeter will be on the negative (−) side of zero. When less electricity is being consumed than the generator is supplying, the pointer will be on the positive (+) side of zero.

(3) **VOLTMETER** (figs. 11 and 12). Some vehicles having 12-volt electrical systems are equipped with a voltmeter which may be switched in and out of the battery circuit to determine the voltage of the battery. A plate (fig. 15) attached to the instrument panel explains the use of the voltmeter. Leave the switch on only long enough to take a reading and then switch it off.

3/4-TON 4 x 4 TRUCK (DODGE)

(4) **THERMOMETER** (figs. 11 and 12). The thermometer shows the temperature of the cooling solution in the engine.

(5) **FUEL GAGE** (figs. 11 and 12). This gage indicates the quantity of fuel in the tank, when the ignition switch is turned on.

(6) **SPEEDOMETER** (figs. 11 and 12). The speedometer indicates the speed of the vehicle in miles per hour. The needle is of the luminous type, visible in the dark. The odometer at the top of the speedometer face registers the total mileage covered by the vehicle. The trip mileage odometer at the bottom of the speedometer face may be returned to a zero reading by pushing in and turning the set stem on the back of the speedometer.

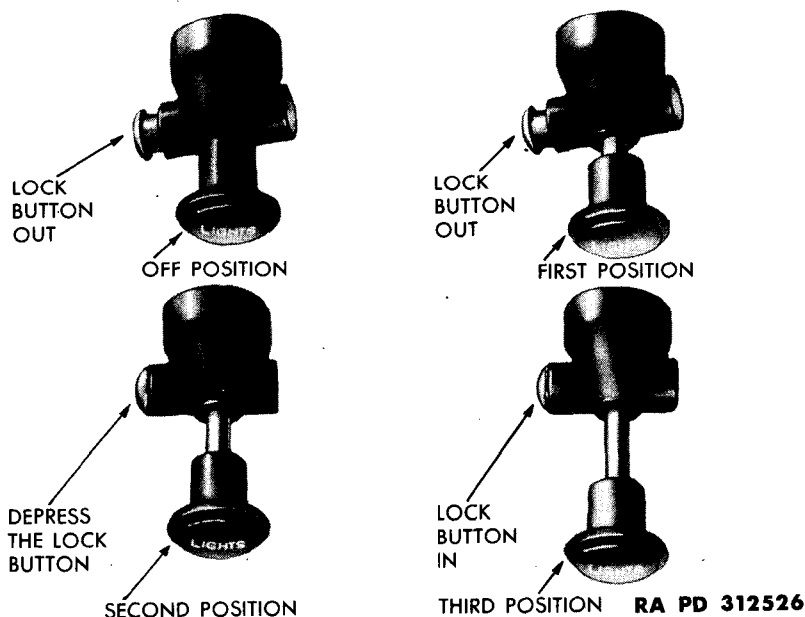

Figure 16—Main Lighting and Blackout Switch Positions

1. Main Lighting and Blackout Switch (fig. 16). This switch controls all vehicle lights except the dome lights in the Ambulance, which operate independently of the main lighting and blackout switch. The switch has four positions:

(1) **OFF POSITION**. All lights except Ambulance dome lights are inoperative. The Ambulance dome lights are controlled by a toggle switch on the left side of the instrument panel.

(2) **FIRST POSITION**. All blackout lights are operative. Service lights are inoperative except Ambulance dome lights.

(3) **SECOND POSITION**. All service lights are operative. Blackout lights are inoperative.

DRIVING CONTROLS AND OPERATION

(4) **THIRD POSITION.** Service stop light is operative. All other lights, except Ambulance dome lights are inoperative.

m. Instrument Light Switch (figs. 11 and 12). This switch is the push-pull type. When pulled out, the instrument lights will light provided the blackout switch is pulled out to the second position (subpar. l above).

n. Headlights. The two headlights mounted on the front fenders are controlled by the main lighting and blackout switch (subpar. l above) and beam control switch (figs. 13 and 14), which controls the high and low beams of the headlights when they are turned on by the blackout switch. Press the button with the foot to raise or lower the headlight beams. The switch locks each time the button is pressed. The headlight beam indicator (figs. 11 and 12), is illuminated only when the high beam of the headlights is turned on.

o. Blackout Parking Lights. These lights (both head and tail) contain specially shaped openings which enable the driver of a vehicle to estimate the distance between his vehicle and another vehicle during blackout conditions.

p. Blackout Driving Light. The blackout driving light is located on the left front fender. It contains a sealed beam unit which is constructed so that the beam of light is diffused, casting a fine spray of limited illumination visible to the driver under blackout driving conditions. The light is controlled by a switch (figs. 11 and 12) of the push-pull type. When pulled out, the blackout driving light will light provided the blackout switch is pulled out to the first position (subpar. l above).

q. Tail and Stop Lights. These lights are controlled by the blackout switch (subpar. l above).

r. Spotlight (Ambulance). The spotlight will operate only when the blackout switch is pulled out to the second position (subpar. l above). The switch is mounted on the control handle.

s. Dome Light Switch.

(1) **AMBULANCE.** A toggle switch controls the dome lights in the roof of the Ambulance (fig. 12). These lights operate independently of the main lighting and blackout switch.

(2) **CARRYALL.** The dome light switch is incorporated in the dome light. It may be turned on only when the blackout switch is in the second position (subpar. l above).

t. Trailer Wiring Connector (Weapon Carrier). This connector is used for hooking up trailer lights with the vehicle lighting system. The blackout switch controls trailer lights in the same manner as other vehicle lights.

u. Fuel Pump Hand Primer. The fuel pump is equipped with a hand primer which permits manual operation of the fuel pump to force fuel to the carburetor in the event it runs dry.

v. Horn Button (figs. 13 and 14). This button operates the horn.

3/4-TON 4 x 4 TRUCK (DODGE)

w. **Roof Ventilator Switch (Ambulance)** (fig. 12). This toggle switch controls the roof ventilator when the ignition switch is turned on.

x. **Heater Switches (Ambulance).**

(1) **HEATER DEFROSTER BLOWER SWITCH** (fig. 12). This rheostat-type switch is operated by rotating the knob of the switch. A slight rotating motion of the knob puts the defroster motor in full speed operation, and turning it farther reduces its speed.

(2) **HEATER SWITCH** (fig. 12). This switch is operated by rotating the knob of the switch. A slight rotating motion of the knob puts the motor in fast speed operation. Rotating the switch farther decreases motor operation to medium speed and finally to slow speed.

y. **Windshield Wipers** (figs. 13 and 14). The windshield wiper motors are controlled by a push-pull type knob on the back of wiper body.

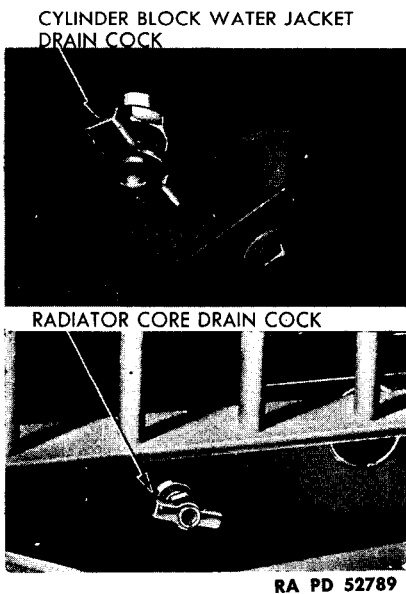

Figure 17—Cooling System Drain Cocks



Figure 18—Hold-down Straps

6. PREPARATION OF NEW VEHICLE FOR SERVICE.

a. **General.** Before placing a new vehicle into service, it should be completely inspected for evidence of damage or looseness of parts resulting during the transportation of the vehicle. Particular consideration should be given the following items during the inspection:

DRIVING CONTROLS AND OPERATION

(1) **TIGHTEN COOLING SYSTEM DRAIN COCKS** (fig. 17). See that the radiator drain cock and the cylinder block drain cock are securely tightened.

(2) **TIGHTEN BATTERY CONNECTIONS**. See that cables at battery, cranking motor and ground at frame or engine are connected securely. Check electrolyte level in battery and fill to proper level.

(3) **INSPECT BRAKE MASTER CYLINDER**. Remove filler plug and inspect level of brake fluid. Level should be $\frac{3}{4}$ inch below top of filler opening in reservoir cover. If so equipped, remove rubber nipple installed over vent opening for shipping purposes.

(4) **LUBRICATE VEHICLE**. Lubricate the vehicle completely. Refer to paragraph 24 for instructions.

(5) **INSPECT WHEELS AND TIRES**. Inflate or deflate tires to 40 pounds pressure. Tighten wheel stud nuts, front and rear axle drive flange nuts and rim nuts securely.

(6) **REMOVE HOLD-DOWN STRAPS** (fig. 18). On rail shipped vehicles, hold-down straps are fastened to the frame side members under each fender. Make sure the straps are removed to avoid interference between the straps and other vehicle parts.

(7) **PERFORM BEFORE-OPERATION SERVICE** (par. 19).

7. USE OF INSTRUMENTS AND CONTROLS IN VEHICULAR OPERATION.

a. **Starting the Engine**. Before attempting to start the engine, make sure the power take-off control lever for operation of winch on vehicles so equipped is in neutral position with safety catch locked. Then proceed as follows:

(1) Apply the hand brake.

(2) Put the transmission gearshift lever in neutral position.

(3) If the engine is cold, pull the choke button all the way out.

NOTE: *If the engine is warm, see that the choke button is pushed all the way in.*

(4) Pull out the throttle control button about $\frac{1}{3}$ of its total movement or to a point where the engine will run a little above idling speed.

(5) Depress the clutch pedal to relieve the engine of the load of turning the transmission gears.

(6) Turn on the ignition switch and push the cranking motor pedal with the foot. To prevent damage to the starting mechanism, release the cranking motor pedal immediately when the engine starts. If the pedal does not release under its own spring mechanism stop the engine immediately by turning off the ignition switch and pull the pedal back by hand.

(7) If the battery, ignition, and fuel systems are in good condition, the engine should start immediately. If the engine does not start within 10 to 15 seconds, release the cranking motor pedal and wait a few seconds to prevent overheating and possible damage to the

3/4-TON 4 x 4 TRUCK (DODGE)

cranking motor. Then push the cranking motor pedal again for 10 to 15 seconds. If the engine does not start after several attempts, report the trouble to the proper officer.

(8) After the engine has started, release the clutch pedal. Then push the throttle control button part way in to reduce engine speed and push the choke control button in to a point where the engine runs smoothly. **CAUTION:** *Push the choke control button all the way in as soon as the engine will operate without stopping.*

b. Starting the Engine after Running Out of Fuel. If the vehicle has been run until the fuel tank is empty, fill the tank and use the fuel pump priming lever to force fuel up to the bowl of the carburetor (fig. 19) to avoid unnecessary use of the battery and starting motor. Operate the priming lever 30 to 40 strokes, or until

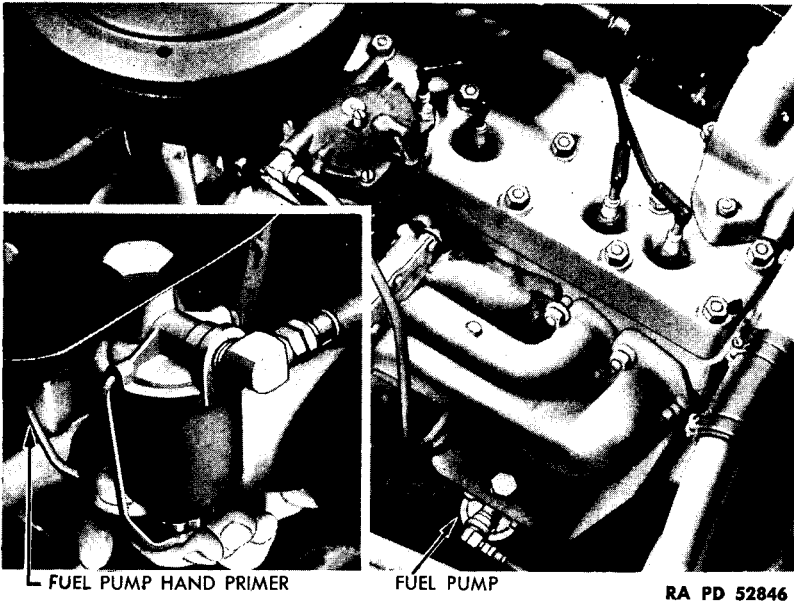

Figure 19—Operating Fuel Pump Hand Primer

the priming lever works freely and very little pressure is required to move it. Free movement of the lever indicates that the fuel tubes, filter, fuel pump, and carburetor bowl, are full of fuel. The engine may then be started in the usual manner. **NOTE:** *If the lever moves freely without actuating the diaphragm, crank the engine one revolution so that the fuel pump rocker arm will move off the high point of the cam on the camshaft.*

c. Driving the Vehicle (fig. 20). The best method of gearshifting the vehicle is known as double-clutching, and the following instructions are based on this method. Although the vehicle is equipped

DRIVING CONTROLS AND OPERATION

with front and rear axles for four-wheel driving, the position of the transfer case hand lever, which controls engagement and disengagement of the front axle, does not alter the procedure of shifting transmission gears. Subparagraph e below contains instructions for driving in four-wheel drive.

- (1) Release the hand brake.
- (2) Disengage the clutch (depress clutch pedal) and move the transmission gear shifting lever to first or second speed forward position. If the vehicle is standing on rough terrain or facing upward on a grade, shift to first speed; if on a smooth hard level surface, shift to second speed.
- (3) Next, press the accelerator to speed up the engine a little and at the same time gradually relieve pressure on the clutch pedal.
- (4) When the clutch is fully engaged, press the accelerator until the vehicle attains the desired road speed.

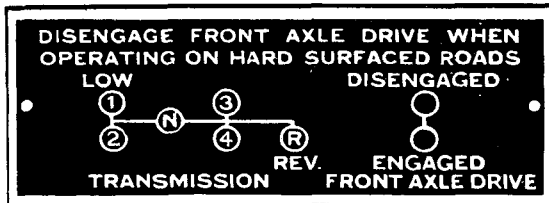

RA PD 52713

Figure 20—Gearshift Diagram Plate

(5) When the vehicle is in motion, shift into higher speeds as follows:

(a) Disengage the clutch and release the accelerator pedal at the same time.

(b) Move the gearshift lever to neutral and relieve pressure on the clutch pedal to allow the clutch to engage. This synchronizes the speed of transmission gears with the speed of the engine.

(c) Again disengage the clutch and move the gearshift lever to the next higher speed position.

(d) Relieve pressure on the clutch pedal and press the accelerator pedal to attain the desired road speed.

(e) Repeat steps in steps (a) through (d) above for successive shifts from first or second speed to higher speeds.

d. Reversing. Bring the vehicle to a complete stop before shifting into reverse speed. Depress the clutch pedal, move the gearshift lever to reverse position (fig. 20). Then release the clutch pedal and press the accelerator pedal at the same time until the desired speed is attained.

e. Driving in Four-wheel Drive. The purpose of four-wheel drive is to permit maximum traction at all four wheels when driving on

3/4-TON 4 x 4 TRUCK (DODGE)

icy roads, through snow or mud, or over rough unimproved terrain. On smooth, level, hard-surfaced roads and under ordinary conditions, disengage the front axle drive and drive with the rear wheels only. **CAUTION:** *Never operate the vehicle at speeds in excess of 25 miles per hour when the front axle is engaged.*

(1) **ENGAGE FRONT AXLE** (fig. 20). Shift the hand lever to the rear with the vehicle moving and engine under mild acceleration. The speed of the vehicle must not exceed 25 miles per hour when the shift is made. If resistance is felt midway in the shift, let up on the accelerator pedal and complete the shift. The shift may also be made with the vehicle standing still, but an easier shift can be accomplished with vehicle in motion.

(2) **DISENGAGE FRONT AXLE** (fig. 20). Push the hand lever forward.

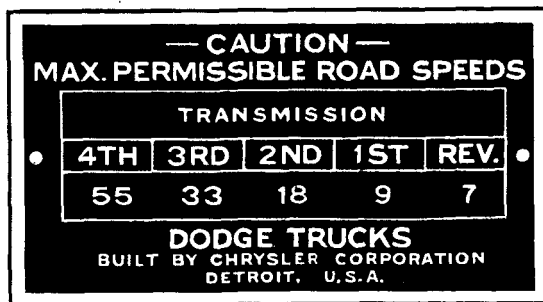

RA PD 52712

Figure 21—Speed Caution Plate**f. Driving Up or Down Steep Grades.**

(1) When driving down a steep grade, shift into a lower transmission gear. On exceptionally steep and long downgrades, shift the transmission to second speed so that the engine will help in slowing the vehicle down and reduce the necessity for continuous or severe application of the brakes.

(2) When driving up a long, steep grade, shift the transmission to a lower gear when vehicle speed begins to decrease, to permit driving the vehicle at the maximum possible governed speed with the least strain on engine and drive mechanism.

(3) To shift to lower gears with the vehicle in motion on a steep grade, use the double-clutch method, and start the shift to the lower gear at the speed shown on the "MAX PERMISSIBLE ROAD SPEEDS" caution plate (fig. 21) for the gear into which the shift is to be made. To double-clutch, proceed as follows:

(a) Disengage the clutch and move the gearshift lever to neutral position.

DRIVING CONTROLS AND OPERATION

(b) Quickly engage the clutch and accelerate the engine to governed speed so that the transmission gears can be meshed in the next lower gear.

(c) Then again disengage the clutch and shift immediately into the next lower gear.

(4) When shifting to a lower gear with vehicle in motion, engage the clutch before allowing the engine to slow down. If the engine is allowed to slow down and the clutch is then engaged, excessive strain will be applied to the clutch, transmission, and drive line, and breakage is very likely to occur.

g. **Stopping the Vehicle.** Relieve pressure on accelerator pedal and apply the brakes. When the vehicle has been slowed down to five or ten miles per hour, disengage the clutch and move the gear-shift lever to neutral position. Then bring the vehicle to a complete stop, release the clutch pedal and apply the hand brake.

h. **Stopping the Engine.** Allow the engine to slow down to idling speed and turn off the ignition switch.

i. **“Breaking-in” Speeds.** New vehicles should be driven carefully during the breaking-in period. Vehicle speed should not exceed 25 miles per hour during the first 500 miles of operation. Also, careless operation in the lower gears may result in excessive engine speed in spite of low vehicle speed. For example, the following vehicle speeds in the lower gears are comparable to 25 miles per hour in high gear:

3rd gear	15 mph
2nd gear	8 mph
1st gear	4 mph

During the next 1,500 miles of operation, the maximum speeds indicated above should be increased for brief periods, until the breaking-in process is completed. However, during this breaking-in, the vehicle should be driven carefully when under full throttle, as maximum power should not be required until vehicle has been driven 2,000 miles.

j. **Maximum Permissible Road Speeds** (fig. 21). The vehicle is equipped with a governor which limits the maximum road speed of the vehicle in the various gears as shown on the plate attached to the instrument panel of the vehicle. **CAUTION:** *Do not permit the vehicle to exceed maximum road speeds in any gear when driving downhill, because the excessive engine speed developed under such conditions might cause serious damage to the engine or power train.* To control the speed of the vehicle, use the foot brake intermittently in order to prevent excessive engine speeds. The clutch must never be disengaged when descending a hill in a low gear.

8. TOWING THE VEHICLE.

a. **Tow Hooks.** The two tow hooks bolted to the frame side members at the front of the vehicle can be used to attach towing chains or cables.

3/4-TON 4 x 4 TRUCK (DODGE)

b. **Pintle Hook.** The pintle hook (fig. 22), mounted on the frame rear cross member, can be used to attach the tow bar of a trailer, or to attach a towing chain or cable for towing another vehicle. To open, release the trigger underneath the hook and pull the jaw open. To close, engage the jaw with the trigger lock and push it to the closed position.



PRESS LATCH
TO RELEASE JAW

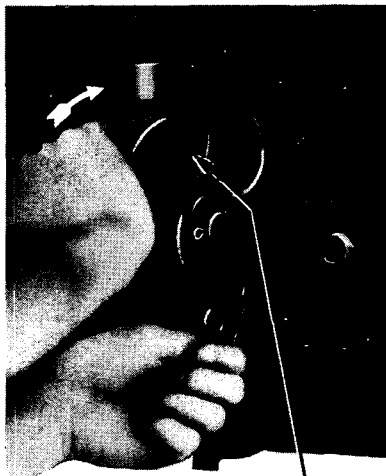

JAW CAN BE CLOSED AND LOCKED
BY BACKING OPEN JAW AGAINST
A TRAILER TOW-BAR

RA PD 312527

Figure 22—Pintle Hook

c. **Towing Vehicle to Start Engine.** Turn the engine over 3 revolutions by hand. Attach a towing cable. Disengage the clutch and shift the transmission of the towed vehicle to high gear. If shifted to lower gears, the engine of the towed vehicle will turn over at a greater speed and more power will be required to tow it. Shift the transmission of the towing vehicle to low gear and begin towing. When the towed vehicle is in motion (five to ten miles per hour), slowly engage the clutch and turn on the ignition switch.

d. Towing Precautions.

(1) When steering the towing vehicle in a different direction, make changes in direction in such a manner that the wheels of the towed vehicle will follow in the tracks of the towing vehicle.

(2) When entering soft or muddy terrain, see that the front wheels of both vehicles are in the straight ahead position, as it is more difficult to pull a towed vehicle with the front wheels at an angle.

(3) Use care to prevent front wheels of towed vehicle becoming entangled with towing cable.

DRIVING CONTROLS AND OPERATION

9. BODY EQUIPMENT.

a. Windshield.

(1). OPEN CAB MODELS (fig. 23). To open the windshield glass, loosen the lock nuts, pull up on the adjusting arms, and push the glass outward to the desired position. Then tighten the lock nuts. To lower the windshield assembly, pull up on the clamp handles which hold the windshield in an upright position. Push the windshield assembly forward to the pad on the hood and fasten the catch. To raise the windshield assembly, unhook the catches on the hood. Then pull the windshield to an upright position and push the clamp handles down to the locked position. Hook the catch on hood to the catch rest.

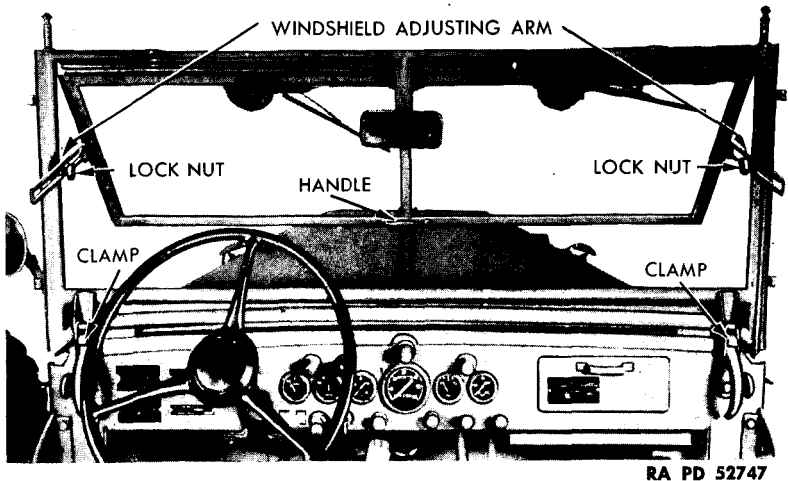

Figure 23—Windshield (Open Bodies)

(2) CLOSED CAB MODELS (fig. 24). To open the windshield glass, pull the handle in the center of the windshield at the lower edge and turn it counterclockwise. Loosen the adjusting arms lock nuts, pull up on the adjusting arms, and push the glass outward to the desired position. Tighten the lock nuts. To close the windshield glass, loosen the lock nuts and pull the windshield to the closed position with the pull-to handle and turn it clockwise. Then tighten both lock nuts evenly to prevent looseness and strain on the windshield glass at the sides.

b. Lowering Folding Top (Command) (fig. 25).

(1) Loosen the lock nuts and set screws at the upper left and right sides of the windshield. Loosen the large hand-operated knobs in the top frame directly above the back of the front seat.

(2) Unsnap seven fasteners of rear curtain on each side. Do not unsnap the nine fasteners on the rear of the body. Unbuckle the two

3/4-TON 4 x 4 TRUCK (DODGE)

long straps between the top frame rear bow and the body and pass the ends without buckle under the top fabric fastened to the rear of body. Let the ends of the straps hang down over the rear of the body. Lift the top off the windshield stanchions and allow it to drop back toward the rear of the body.

(3) Fold the top frame down by pulling inward on each side at the location of the large hand knobs. To prevent cutting or chafing of fabric, allow the top decking to fall loosely over the rear of the body so that the fabric will not catch between the bows of the frame as it is folded back. **CAUTION:** *Pull the rear curtain back as far as possible to prevent breakage of the rear glass by the top frame as it is folded down.*

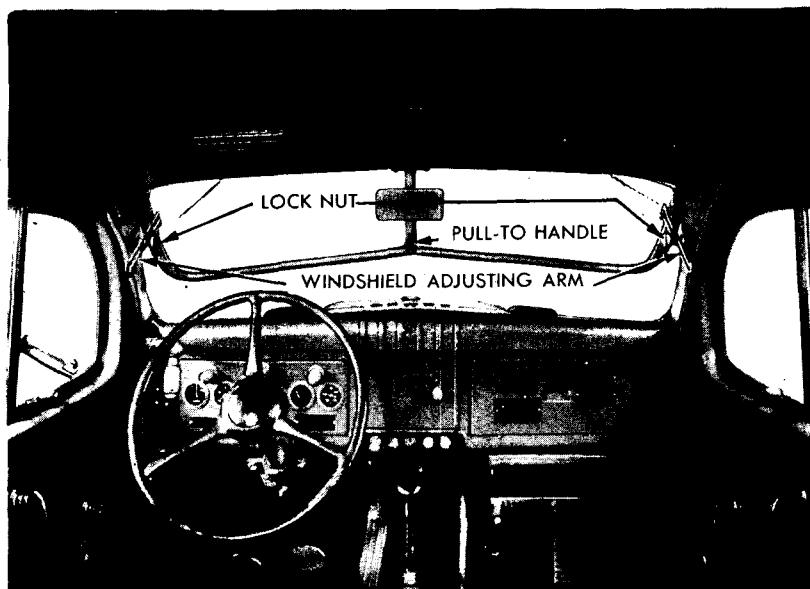

RA PD 52748

Figure 24—Windshield (Closed Bodies)

(4) Tie the top frame down at the center with the short strap and fold the top decking neatly up over the top frame. Tuck the loose ends under the frame and tie down with the long straps.

c. Raising Folding Top (Command) (fig. 25).

(1) Unbuckle the long straps and let the loose ends hang down over rear of body. Unbuckle the short strap. Unfold the top fabric and let it hang down over the rear of the body. Raise the top frame and straighten out both sides at the location of the large hand-operated knobs.

DRIVING CONTROLS AND OPERATION

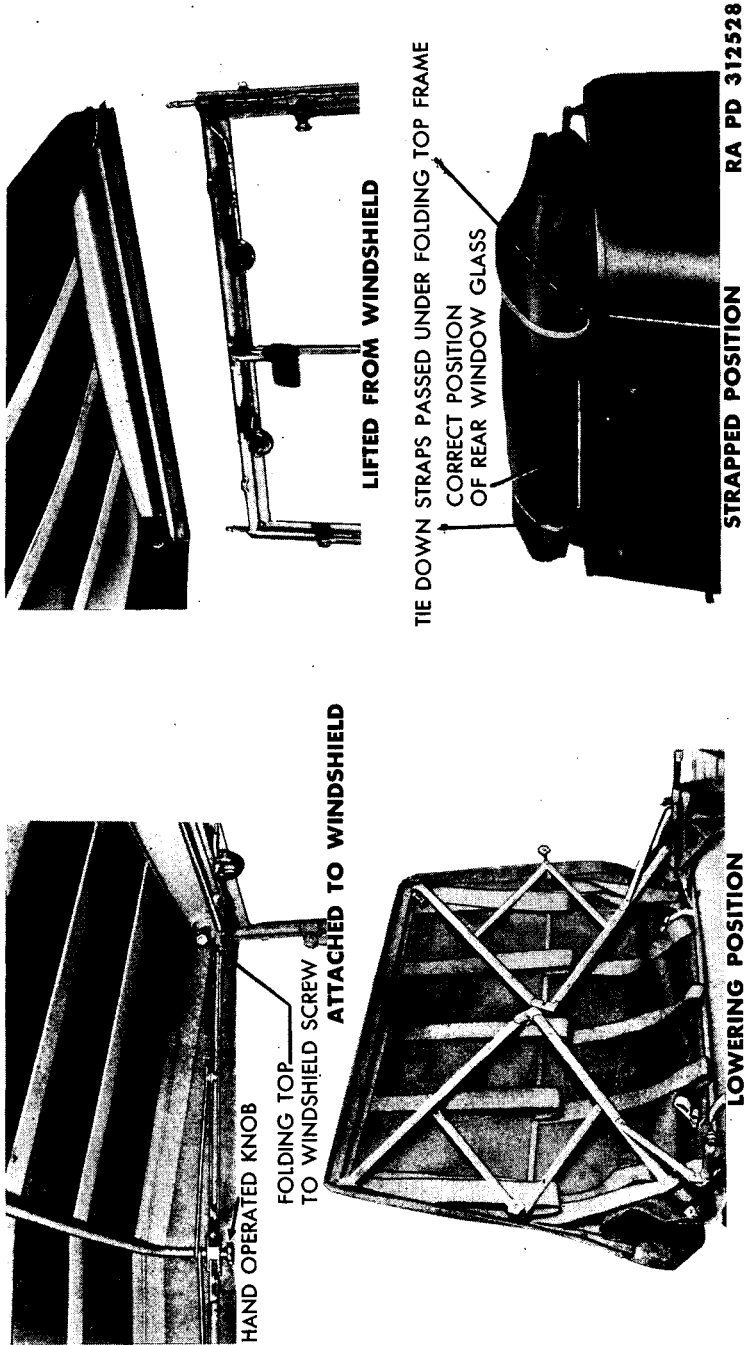

Figure 25—Folding Top Positions (Command)

3/4-TON 4 x 4 TRUCK (DODGE)

(2) Let the top frame rest on the windshield and tighten the large hand-operated knobs securely into position in the recesses in the top frame sides.

(3) Engage the hole in the top frame with the knob of one windshield stanchion, but do not force the frame all the way down on the stanchion. Force the other side of the top frame over the knob of the windshield stanchion. Spring the top frame as necessary to secure alinement between the stanchion knob and hole in the top frame.

(4) See that both sides of the top frame are pushed down until the stanchions are fully entered into the holes in the top frame. Tighten the lock nuts and set screws securely at the stanchions to prevent the top flying up when the vehicle is in motion. Place the long straps in position over the rear bow of the top frame to relieve strain on fabric and fasten the snap fasteners on each side of the top at the rear.



FIRST FOLD



SECOND FOLD



THIRD FOLD

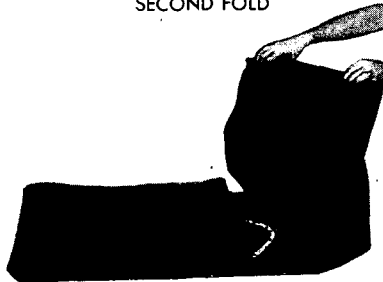

FINAL FOLD RA PD 52726

Figure 26—Folding Roof Tarpaulin (Weapon Carrier)

d. **Side Curtains (Command).** Four side curtains are supplied with this model. The two front side curtains are fitted with a metal frame with three hinge pins which fit into brackets on the sides of the windshield. The two rear side curtains are fitted with a frame and two hinge pins which fit into brackets on the body at the rear of the front seat-back and in the top frame directly above. When side curtains are installed, see that curtains are between the flaps of the top and close all snap fasteners. To hold the side curtains in the closed position, turn the lock handles just inside the body open-

DRIVING CONTROLS AND OPERATION

ing. When the side curtains are not in use, fold them carefully and place them in the storage space in the tail gate compartment.

e. Removal of Tarpaulin (Weapon Carrier).

(1) Turn the fasteners on the front of the windshield and pull the driver's compartment cover off the fasteners. Unbuckle the straps on the roof tarpaulin and lift off the cover.

(2) Lift the front seats and untie the roof tarpaulin ropes at the two hooks on the front of the body. Untie the ropes at hooks on rear and sides of the body. Open the snap fasteners on the center bow. Remove the roof tarpaulin and fold as shown in figure 26.

(3) Untie the ropes for the front and rear end curtains at the hooks on the sides of the body. Remove the rope laced through the eyelets in the curtains and around the front and rear top bows.

(4) Remove the roof ridge pole. Lift the front and rear bows out of the brackets on the body and remove the center bow.

f. Installation of Tarpaulin (Weapon Carrier).

(1) **INSTALL THE TOP BOWS IN THE BRACKETS IN THE BODY.** Install the bolts and nuts through the bracket for the center bow. Then install the ridge pole through the brackets on the top bows and fasten with bolts and wing nuts.

(2) **INSTALL THE FRONT AND REAR END CURTAINS.** Place the rope through the center eyelet in the end curtain. Adjust the two ends of the rope so that even amounts protrude from each side of the center eyelet. Place the end curtain on the top bow with the curtain flap facing toward the outside. Hold it in position temporarily by tying with cloth straps around the top bow. Lace the rope through the eyelets of the curtain and tie the rope to the hooks on the sides of the body.

(3) **INSTALL THE ROOF TARPAULIN.** With the tarpaulin folded as shown in figure 26, center it on the top bows at the juncture of the ridge pole and the center top bow. Unfold down over bows. See that the pads for the straps are on the outside, and the part of the tarpaulin labeled front is at the front of the vehicle. Adjust the position of the tarpaulin so that the three pads for the straps along each side of the tarpaulin are directly over the corners of the three top bows. Lace the ropes through the eyelets in the bottom of the front and rear curtains and tie the ropes on the hooks on the body. Place the cloth strap around the center bow and close the snap fastener. Attach the driver's compartment cover and fasten the cover to the roof tarpaulin by buckling the four straps to the roof tarpaulin.

3/4-TON 4 x 4 TRUCK (DODGE)

Section IV

AUXILIARY EQUIPMENT CONTROLS AND OPERATION

	Paragraph
Winch controls	10
Fire extinguishers	11

10. WINCH CONTROLS.

a. **General.** The Weapon Carrier and Command are equipped with a winch mounted on the front of the vehicle. Power for winch operation is supplied by the engine of the vehicle. The winch can be used as an auxiliary source of power to help lift or move a mired vehicle. It can be used to move another vehicle, or the vehicle on

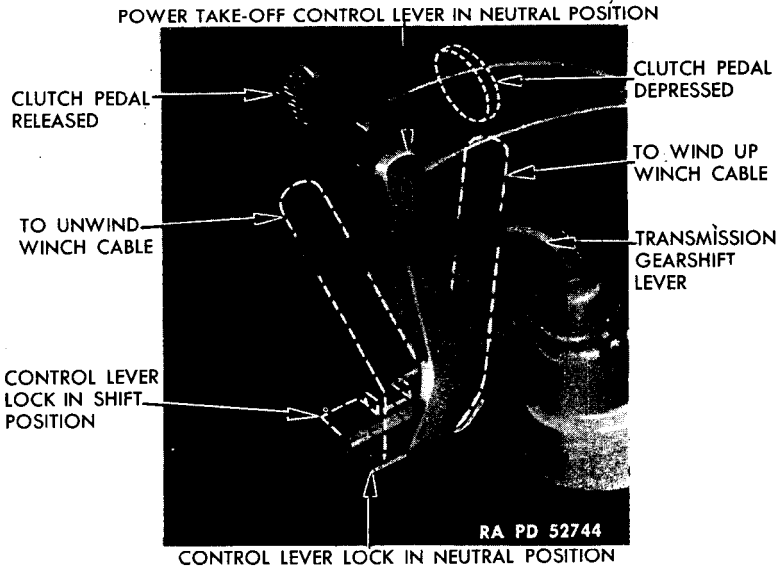
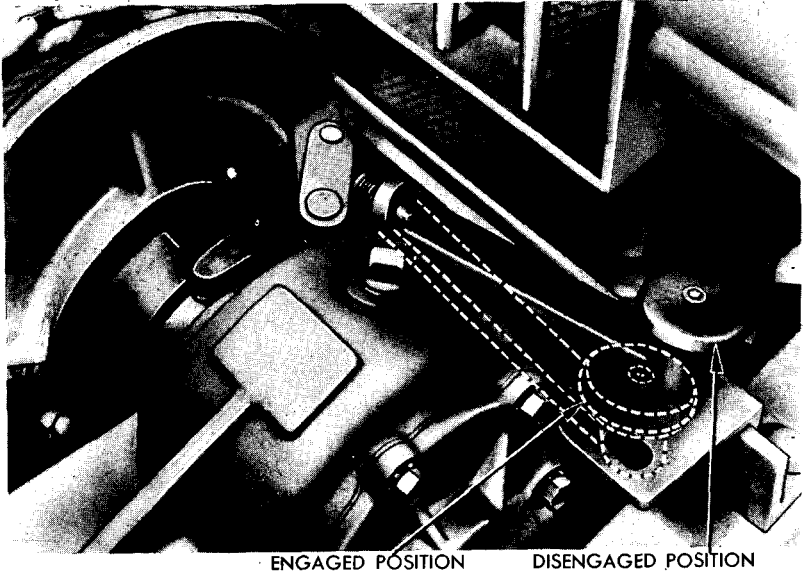

Figure 27—Winch Control Lever Positions

which it is mounted, by rigging the winch cable and snatch block to suitable anchorage.

b. **Winch Controls** (fig. 27). The winch is controlled by a lever in the driver's compartment and a clutch shifter fork handle mounted on the winch. The lever is locked in neutral position by a safety catch, which must be lifted before the lever can be moved.

AUXILIARY EQUIPMENT CONTROLS AND OPERATION



RA PD 52745

Figure 28—Winch Clutch Shifter Fork Handle Positions

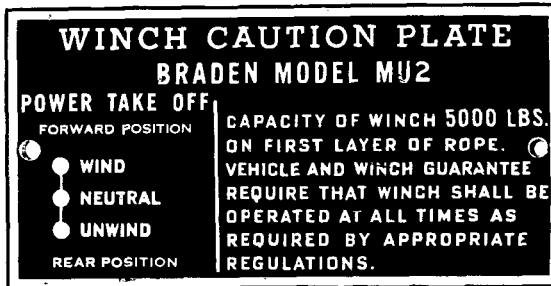

RA PD 52746

Figure 29—Winch Caution Plate

c. To Hook On.

(1) Make sure the transmission gearshift lever is in neutral position.

(2) Disengage the clutch shifter fork handle at the winch (fig. 28) and pull out the cable.

(3) If the cable is under a strain, depress the vehicle clutch pedal and move the control lever to the rear (unwind) position. Then run the engine at idling speed to relieve the strain on the cable.

3/4-TON 4 x 4 TRUCK (DODGE)

(4) Rig the cable to suitable anchorage. Always rig up the cable so that it will be pulled straight into the winch drum.

d. To Pull.

(1) When using the winch, operate the engine at a reasonable speed. High engine speeds are liable to damage the winch mechanism or cause other serious trouble. Note winch caution plate (fig. 29) which is attached to the instrument panel of each winch-equipped vehicle.

(2) Engage the clutch shifter fork handle (fig. 28).

(3) Depress the vehicle clutch pedal and shift the winch control lever to forward position (fig. 27).

(4) Release the vehicle clutch pedal and accelerate the engine to pull or lift the load.

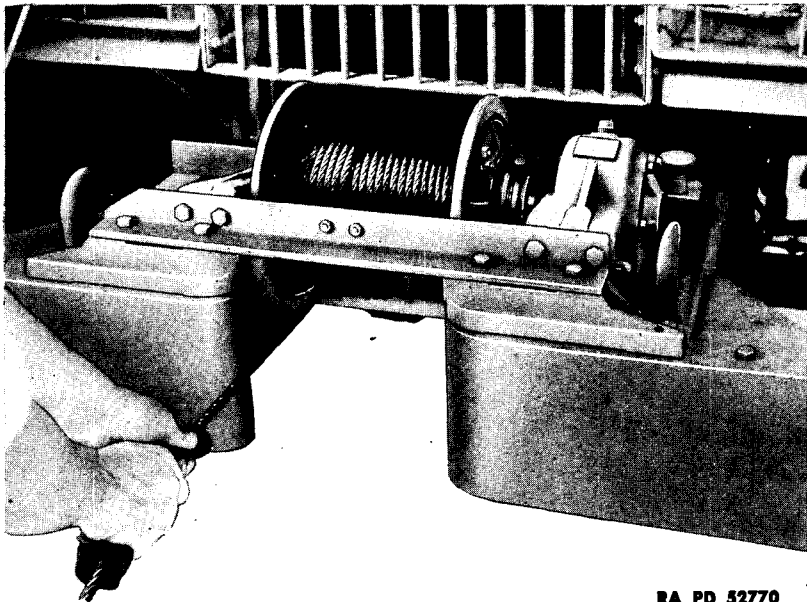

RA PD 52770

Figure 30—Winding Winch Cable on Drum

(5) If the winch is being used to assist the vehicle on which it is mounted, place the transmission gearshift lever in first speed (or reverse) and utilize the driving wheels of the vehicle to assist in pulling the vehicle. The transfer case control lever may be placed in position for four-wheel drive or rear wheel drive depending on the condition of the terrain.

e. To Reverse Winch Operation.

(1) With engine running at idling speed, depress the vehicle clutch pedal and move the winch control lever to the rear (unwind) position.

AUXILIARY EQUIPMENT CONTROLS AND OPERATION

(2) Release the vehicle clutch pedal. Do not accelerate the engine when reversing winch operation.

(3) Never try to lower load by disengaging clutch shifter fork.

f. Winding Cable on Drum (fig. 30).

(1) To wind the cable on the drum, secure the end of it to a suitable anchorage and allow the winch to pull the vehicle towards the anchorage. This will help maintain tension on cable as it is being wound on drum.

(2) Guide the cable as it winds on the drum so that the first layer of coils are very close together to prevent the next layer of cable pressing down between the coils of the first layer.

(3) After the first layer is correctly wound on drum, the cable will tend to follow the coils of the first layer, but start and end each successive layer at the extreme edge of the drum.

(4) If the cable shows signs of rust or is excessively dirty, unwind cable and clean. Lubricate with engine oil applied with a cloth as the cable is being rewound on drum.

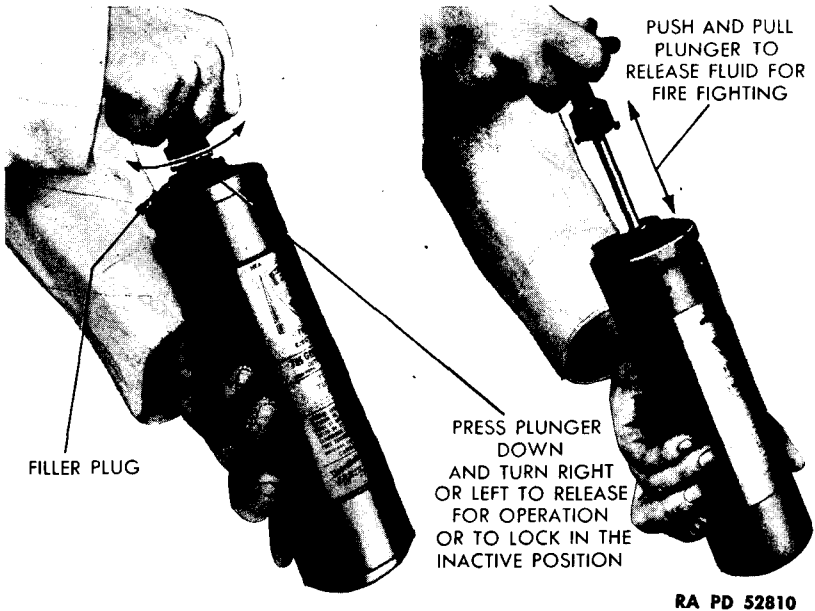

Figure 31—Operating Fire Extinguisher

11. FIRE EXTINGUISHERS.

a. **Location.** The fire extinguisher is mounted on the right cowl side panel on all except the Ambulance, where it is located to the rear of the right front door. On later model Weapon Carriers, it is located on the front of the seat riser. To remove the fire extinguisher,

3/4-TON 4 x 4 TRUCK (DODGE)

release the spring lock at the extinguisher handle and lift it out of the bracket, or if equipped with a clamp type bracket, pull it out of clamp.

b. Fire Classifications. The fire extinguisher is the vaporizing liquid type. It may be used on any class of fire resulting from burning wood, textile, oil, grease, gasoline, flammable liquids, or electrical short circuits. It may be used on burning electrical equipment in the vehicle, such as generator, cranking motor, or wiring connections.

c. Operation (fig. 31). To operate the extinguisher, turn the handle and work it like a pump. To secure best results, direct the discharge at the base of the flame. When used on burning liquids in a container, direct the discharge against the inside of the container just above the burning liquid.

d. Care. Keep the extinguisher clean. Wipe the exterior at the top and around the handle to remove dirt and other matter which might tend to obstruct operation of the extinguisher. After use, exchange the extinguisher immediately for one that is fully charged.

e. Test. Test by pumping some of the fluid in a clean glass container. If the pump works satisfactorily, and the fluid in the glass container is clean and free of foreign matter, pour the liquid back into the extinguisher through the hole in the cap. Then, if the extinguisher is full of fluid (1 qt liquid capacity), it is in normal operating condition. If the pump does not operate satisfactorily, or the extinguisher contains insufficient or dirty fluid, exchange the extinguisher for one that is in satisfactory operating condition.

Section V

OPERATION UNDER UNUSUAL CONDITIONS

	Paragraph
General	12
Unusual operation	13
Cold weather operation	14
Hot weather operation	15
Flood and submersion	16
Decontamination	17

12. GENERAL.

a. Vehicle operation over dusty terrain, through deep mud or in extreme temperatures imposes unusual demands on various parts of the vehicle and the necessary precautions should be taken before and during operation to avoid unnecessary failures.

13. UNUSUAL OPERATION.

a. Sand, Deep Mud, and Slippery Terrain.

(1) **PREPARATION.** Inspect and clean air cleaners and lubricate chassis lubricant fittings more frequently than under normal driving conditions.

(2) **DRIVING IN SAND OR SOFT TERRAIN.** Drive slowly in loose, dry sand or fresh, thick gravel. Even though greater vehicle speed can be attained on certain types of sand and gravel surfaces, such surfaces are unpredictable and great difficulty may be encountered in steering the vehicle. When starting the vehicle in loose sand or gravel, release pressure on the clutch pedal slowly so that the wheels will not spin. Spinning the wheels causes them to work farther down into the soft surface which may result in the vehicle becoming mired to such an extent that it will have to be towed or winched out.

(3) **DEEP MUD AND SLIPPERY TERRAIN.** When the vehicle becomes mired in soft terrain or deep mud, use good judgment if an attempt is made to drive the vehicle out under its own power. If the vehicle is pulling through soft mud with the front axle engaged, and the driving wheels start spinning, do not race the engine or attempt to "jump" the vehicle out of the mud by racing engine and suddenly engaging the clutch. Racing the engine usually results in digging the driving wheels deeper into the mud, and trying to "jump" the vehicle will lead to destruction of some part of the drive line, such as the clutch, transmission, propeller shafts, or axles. When the vehicle is hopelessly mired in deep mud, tow it out with a winch or with another vehicle.

14. COLD WEATHER OPERATION.

a. General.

(1) Operation and maintenance of automotive vehicles at low temperatures involve factors not found at normal operating tem-

3/4-TON 4 x 4 TRUCK (DODGE)

peratures, and operators must devote more time to protective maintenance. Failure to provide extra service will result in actual damage, unnecessary and unwarranted expense, and failure to start.

(2) Temperatures have been divided into two ranges: above 0°F, and below 0°F. Metals and lubricants undergo changes in their physical properties below 0°F. In subzero temperatures accessory equipment for supplying heat to engine, fuel, oil, and intake air, is required.

b. Gasoline for Low Temperatures.

(1) **SELECTION.** Use the winter grade of gasoline procured under U. S. Army Specification 2-103, grade C, latest revision.

(2) The formation of ice crystals from small quantities of water in the fuel sometimes causes considerable trouble. To keep water out of the fuel tank, observe the following precautions:

(3) Strain the gasoline through a filter paper or any other type of strainer that will prevent the passage of water. **CAUTION:** *Be sure to provide a positive metallic contact between fuel container and gasoline tank, unless both fuel tank and container are independently grounded.*

(4) In so far as possible, always keep the fuel tanks full. This will reduce the free air space above the fuel from which moisture can be condensed.

(5) Add one quart of denatured alcohol, grade 3, to fuel tank at start of winter season and 1 pint per month thereafter. This will reduce the hazard of ice formation in the fuel.

(6) Do not store fuel in old drums unless they are free from rust and have been thoroughly cleaned. If time is not an urgent factor, do not pump fuel from drum to vehicle until it has settled for 24 hours after filling or moving the drum. Keep portable fuel pumps clean and protected from snow and frost.

(7) When a drum has been opened, be sure to cover the opening or replace the bung to keep out snow, frost, or other foreign matter. Store drums in a covered building or cover them with a tarpaulin.

c. Engine Lubrication.

(1) Engine lubrication at temperatures above 0°F is covered in paragraph 24 and figure 32. The following instructions supplement this information and apply only to instances where the temperature falls below 0°F for long periods.

(2) Several methods of keeping engine oil sufficiently fluid for proper lubrication at temperatures below 0°F are listed below. Give preference to these methods in the order listed according to available facilities.

(a) Keep the vehicle in heated enclosure when not in operation.

(b) When engine is stopped, drain crankcase oil while it is hot, and store in a warm place until vehicle is to be operated again. If warm storage is not available, heat the oil before reinstalling. (Avoid overheating the oil; heat only to the point where the bare

OPERATION UNDER UNUSUAL CONDITIONS

hand can be inserted without burning.) Tag the vehicle in a conspicuous place in the drive compartment to warn personnel that crankcase is empty.

(c) Dilute the crankcase oil with gasoline as follows:

1. Fill engine crankcase to the "FULL" mark with the grade of engine oil prescribed for use at temperatures from $+32^{\circ}\text{F}$ to 0°F . Add $1\frac{1}{2}$ quarts of gasoline to the crankcase.

2. Run the engine 5 to 10 minutes to mix the lubricant and diluent thoroughly.

3. Stop the engine and note that the level of the diluted oil is above the normal "FULL" mark on the oil gage. This level should be marked on the gage for future reference.

4. The presence of a large percentage of light diluent will increase oil consumption and, for that reason, the oil level should be checked frequently. Use the grade of engine oil prescribed for use between $+32^{\circ}\text{F}$ to 0°F to maintain the oil level to manufacturer's "FULL" mark on the gage during operation.

5. If the vehicle is operated 4 hours or more at operating temperature, redilution will be necessary if it is anticipated that the vehicle will be left standing unprotected for 5 hours or more. This can be accomplished by adding engine oil prescribed for use between $+32^{\circ}\text{F}$ to 0°F to the manufacturer's "FULL" mark; then adding gasoline to the dilution mark on the gage described in step 3 above.

d. Transmission, Transfer Case, and Differentials.

(1) Where the use of SAE 10 engine oil is prescribed for use at temperatures $+32^{\circ}\text{F}$ to 0°F , it will be used undiluted for operation below 0°F .

(2) SAE 80 universal gear lubricant, where prescribed, is suitable for use at temperatures as low as -20°F . If consistent temperature below 0°F is anticipated, drain the gear cases while warm and refill with grade 75 universal gear lubricant which is suitable for operation at all temperatures below $+32^{\circ}\text{F}$. If grade 75 universal gear lubricant is not available, SAE 80 universal gear lubricant, diluted with the fuel used in the engine in the proportion of 1 part fuel to 6 parts SAE 80 universal gear lubricant, shall be used. Make-up oil will be diluted in the same proportion before it is added to gear cases.

(3) After engine has been warmed up, engage clutch and maintain engine speed at fast idle for 5 minutes until gears can be engaged. Put transmission in low (first) gear, and drive vehicle for 100 yards, being careful not to stall engine. This will heat gear lubricants to the point where normal operation can be expected.

e. Chassis Lubricants.

(1) At temperatures below 0°F lubricate chassis points with No. 0 general purpose grease.

(2) Brake bands, particularly on new vehicles, have a tendency to bind when they are very cold. Always have a blow torch handy

3/4-TON 4 x 4 TRUCK (DODGE)

to warm up these parts if they bind when you are attempting to move the vehicle. Parking the vehicle with the brake released will eliminate most of the binding. Precaution must be taken, under these circumstances, to block the wheels or otherwise prevent movement of the vehicle.

(3) Inspect the vehicle frequently. Shock resistance of metals, or resistance against breaking, is greatly reduced at extremely low temperatures. Operation of vehicles on hard, frozen ground causes strain and jolting which will result in screws breaking or nuts jarring loose.

(4) Disconnect oil-lubricated speedometer cables at the drive end when operating vehicles at temperatures of -30°F and below. These cables often fail to work properly at these temperatures, and sometimes break due to the excessive drag caused by the high viscosity of the oil with which they are lubricated. Grease-lubricated cables should operate satisfactorily at all temperatures provided they are coated with No. 0 general purpose grease and there is no excess grease in the housing.

f. Antifreeze.

(1) Protect the cooling system with antifreeze compound for operation below $+32^{\circ}\text{F}$.

(2) Before adding antifreeze compound, be sure the cooling system is clean and completely free from rust.

(3) Inspect all hoses and replace if deteriorated. Inspect hose clamps, plugs, and petcocks, and tighten if necessary. Make sure radiator does not leak, before adding antifreeze compound.

(4) After the cooling system is clean and tight, fill with water to about $1/3$ capacity. Then add antifreeze compound, in the quantity shown below:

ANTIFREEZE TABLE

Lowest expected Temperature	Quarts, antifreeze compound
$+10^{\circ}\text{F}$	$4\frac{1}{2}$
0°F	6
-10°F	7
-20°F	8
-30°F	$8\frac{3}{4}$
-40°F	$9\frac{3}{4}$
-50°F	$10\frac{3}{4}$

(5) After adding antifreeze compound, fill with water to slightly below the filler neck; then start and warm the engine to normal operating temperature.

(6) The engine should then be stopped and the solution checked with a hydrometer, adding antifreeze compound if required.

(7) Inspect the coolant weekly for strength and color. Rusty solution must be drained, the cooling system thoroughly cleaned, and new solution of the required strength added. **CAUTION:** Use an accurate hydrometer. To test a hydrometer, use 1 part antifreeze

OPERATION UNDER UNUSUAL CONDITIONS

compound to 2 parts water. This solution should produce a hydrometer reading of 0°F .

g. Other Lubrication Points.

(1) Drain steering gear housing if possible, or use suction gun to remove as much lubricant as possible. Refill with grade 75 universal gear lubricant, or, if not available, with SAE 80 universal gear lubricant diluted with fuel used in the engine in the proportion of 1 part fuel to 6 parts SAE 80 universal gear lubricant. Make-up oil will be diluted in the same proportion before it is added to the housing.

(2) For oilcan points where engine oil is prescribed for above 0°F , use light preservative lubricating oil.

h. Protection of Electrical System.

(1) GENERATOR AND STARTER. Inspect the brushes, commutators, and bearings. See that the commutators are clean. The large surges of current which occur when starting a cold motor require good contact between brushes and commutators.

(2) WIRING. Inspect and clean all connections, especially the battery terminals. Take care that no short circuits are present, and that there is no ice on spark plugs, wiring, or other electrical equipment.

(3) COIL. Check coil for proper functioning.

(4) DISTRIBUTOR. Clean thoroughly, and replace points. Check the points frequently. In cold weather the current is heavier, and the points may pit and burn more than usual.

(5) SPARK PLUGS. Clean, test, and replace, if necessary. If it is difficult to make the engine fire, reduce the gap 0.005 inches. This will make sparking easier at the reduced voltages likely to prevail.

(6) TIMING. Check carefully. Take care that the spark is not unduly advanced or retarded.

(7) BATTERIES.

(a) The efficiency of batteries decreases sharply with decreasing temperatures and becomes practically nil at -40°F . Do not attempt to start the engine with the battery when it has been exposed to temperatures below -30°F , until the battery has been warmed, unless a warm slave battery is available.

(b) A fully charged battery will not freeze at temperatures likely to be found even in arctic climates, while a fully discharged battery will freeze and rupture at $+5^{\circ}\text{F}$. See that the battery is always fully charged with a hydrometer reading between 1.275 and 1.300.

(c) Do not add water to a battery when it has been exposed to subzero temperatures unless the battery is to be charged immediately. If water is added and the battery not put on charge, the layer of water will stay at the top and freeze before it has a chance to mix with the acid. Keep vent holes in filler plugs open. Keep terminals tight and clean. At regular intervals, apply a coating of No. 0 general purpose grease, or light, rust-preventive compound.

(8) LIGHTS. Inspect lights carefully.

3/4-TON 4 x 4 TRUCK (DODGE)**i. General Conditions.**

(1) Make sure that no heavy grease or dirt has been left on the starter throwout mechanism. Heavy grease or dirt may keep the gears from being meshed, or cause them to remain in mesh after the engine starts and thus ruin the starter.

(2) Pull the choke control all the way out to secure the air-fuel ratio required for cold weather starting. Make sure the butterfly valve in the carburetor closes all the way and otherwise functions properly.

(3) Remove or bypass oil filters at temperatures below -30°F , because the viscous oil will not flow freely through them.

(4) Remove and clean sediment bulb, strainer, etc., at frequent intervals.

j. Starting and Operation.

(1) It is possible to start gasoline engines with batteries at temperatures as low as -30°F , if the engines are properly lubricated and in good mechanical condition.

(2) To insure that the engine will start on the first attempt, proper preparation of the engine is very important. Should the engine fire a few times and stop, water vapor which is a product of combustion, may form frost in the combustion chamber and make it impossible to start without heating the engine to above 32°F . Prolonged starting efforts wear down the battery.

(3) Pull the choke lever all the way out for starting, and keep it partially pulled out until the engine has warmed up. Since only the lightest components of the gasoline vaporize in a cold engine, a very rich mixture is necessary. Depress the clutch pedal to ease the starting load.

(4) After the engine is started, idle it at 800 to 1,000 revolutions per minute until it has warmed up enough to run smoothly. Do not place the vehicle in operation under its own power until its operating temperature of 160°F has been reached. Maintain this temperature by covering or partially covering the radiator.

(5) Cover engine with tarpaulin, tent, or portable shed. Place oil stoves, fire pots, or four or five ordinary kerosene lanterns, under the covering about three hours prior to starting time.

(6) Keep vehicles in sheltered areas shielded from wind. Cold winds increase starting difficulties.

k. Stopping. Increase engine speed before turning off ignition. Then turn off ignition and release throttle at the same time. As the engine coasts to a stop, it will blow out all the residual products of combustion, including water vapor, and leave only air and gasoline vapor in the engine.

15. HOT WEATHER OPERATION.

a. Lubrication Attention. Lubricate the vehicle for hot weather operation as instructed in paragraph 24. Do not use engine oil heavier than that recommended on the Lubrication Guide.

OPERATION UNDER UNUSUAL CONDITIONS

b. **Cooling System.** Use the correct radiator cap to prevent the loss of cooling solution. Keep the fan belt tension properly adjusted. Keep the radiator core clean. Remove insects or other foreign material lodged between the fins of the core. To do this, direct a stream of water under pressure through the openings in the core from the engine side of the core.

c. **Manifold Heat Control.** Change the position of the manifold heat control to the summer setting (par. 56).

d. **Ignition System.** During wet or damp weather, dry the distributor cap, spark plugs, and wires with a clean rag if hard starting is experienced.

e. **Fuel and Exhaust Systems.** A heat shield is used over the fuel pump to prevent heat reaching the fuel pump. See that the heat shield is kept in place to prevent engine stopping as a result of vapor lock. A clogged or damaged muffler or tail pipe will cause back pressure and overheating of the engine. If the muffler or tail pipe is damaged during operation, report the condition.

16. FLOOD AND SUBMERSION.

a. **General.** When a vehicle has been driven through deep water heavily laden with dirt and abrasives or completely submerged, certain precautions must be taken to avoid serious damage to the engine, clutch, transmission, transfer case, axles, universal joints, winch, steering gear, battery, fuel tank, brakes, wheel bearings, etc. If it is known that water, dirt, abrasives, or salt water have contaminated the various units of the vehicle, notify the proper authority at once. Each unit which has been submerged must be completely dismantled, cleaned, and lubricated. If units of the vehicle have been subjected to salt water, certain units will be damaged beyond repair.

b. **Emergency Procedure.** If emergency requirements make complete dismantling and cleansing of units impossible, each unit subjected to water should be inspected, cleansed, and lubricated to defer as much damage as possible. *CAUTION: Emergency cleansing cannot be considered as assurance that further damage will not result, and if the damage is great, notify the proper officer at once that complete dismantling and cleansing of affected units is necessary to avoid serious damage.*

(1) **INSPECT BATTERY.** Remove filler plugs. Check electrolyte for level and appearance. Normal level after immersion indicates little or no water has entered battery. Clean electrolyte solution, even though slightly high, indicates no absorption of excess dirt or damaging foreign material. If solution is dirty, replace battery. Test gravity. If the battery is discharged, recharge or replace.

(2) **LUBRICATE VEHICLE COMPLETELY** (par. 24).

(3) **FUEL FILTERS.** Clean fuel filters on dash and in fuel pump (pars. 75 and 76). If fuel tank has been submerged, drain and refill, run engine, and clean fuel filters again.

3/4-TON 4 x 4 TRUCK (DODGE)

(4) **AIR CLEANERS.** Clean and reoil carburetor air cleaner (par. 72), breather pipe air cleaner (par. 65), and ventilator outlet pipe air cleaner (par. 66).

(5) **WHEEL BEARINGS.** Remove all wheel bearings, clean and re-pack with lubricant and reassemble. Replace the oil seals in the wheel hubs, if they are contaminated with dirt, to avoid damage to seal surfaces and lubricant leakage (pars. 144 and 150).

(6) **CLUTCH.** If the clutch has been submerged, notify higher authority that complete dismantling and cleansing is required. Do not attempt to flush the clutch.

(7) **BRAKE MASTER CYLINDER.** If the brake master cylinder has been submerged, notify higher authority, as it will be necessary to drain and flush the brake system completely with alcohol, at least twice, and then refill with fresh brake fluid.

(8) **STARTING MOTOR GENERATOR, DISTRIBUTOR, AND CARBURETOR.** If these units have been submerged, notify higher authority.

(9) **ENGINE.** If it is known that water or dirt has entered engine, drain engine oil, fill crankcase with five quarts of engine oil SAE 10, and run engine for several minutes at just above idling speed, with clutch released. Before draining engine oil and refilling with correct grade of fresh engine oil, remove valve cover plates and, if necessary, clean chamber with dry-cleaning solvent. If this inspection reveals a dirty condition, notify higher authority, as it will be necessary to remove the oil pan and clean the pan and strainer.

(10) **OIL FILTER.** If water or dirt has entered engine, replace oil filter after flushing engine (step (9) above).

(11) **DRIVE LINE UNITS.** If the transmission, transfer case or winch (if so equipped) has been submerged, drain lubricant and refill, using engine oil, SAE 10. Drain front and rear axles completely, and refill with 1/2 gallon of engine oil, SAE 10. Next, with front and rear axle on jacks, drive all four wheels at a speed of approximately 15 miles per hour for 5 minutes to flush the drive line units. Also run the winch to flush it. Then drain all units thoroughly and refill with correct grade of lubricant (par. 24).

17. DECONTAMINATION.

a. Refer to Armored Force Field Manual FM 17-59, covering decontamination of Armored Force Vehicles.

Section VI

FIRST ECHELON PREVENTIVE MAINTENANCE SERVICES

	Paragraph
Purpose	18
Before-operation service	19
During-operation service	20
At-halt service	21
After-operation and weekly service	22

18. PURPOSE.

a. To insure mechanical efficiency it is necessary that the vehicle be systematically inspected at intervals each day it is operated and weekly, so defects may be discovered and corrected before they result in serious damage or failure. Certain scheduled maintenance services will be performed at these designated intervals. The services set forth in this section are those performed by driver or crew Before-operation, During-operation, At-halt and After-operation and Weekly.

b. Driver Preventive Maintenance Services are listed on the back of "Driver's Trip Ticket and Preventive Maintenance Service Record" W. D. Form No. 48 to cover vehicles of all types and models. Items peculiar to specific vehicles but not listed on W. D. Form No. 48 are covered in manual procedures under the items with which they are related. Certain items listed on the form that do not pertain to the vehicle involved are eliminated from the procedures as written into the manual. Every organization must thoroughly school each driver in performing the maintenance procedures set forth in manuals whether they are listed specifically on W. D. Form No. 48 or not.

c. The items listed on W. D. Form No. 48 that apply to this vehicle are expressed in this manual to provide specific procedures for accomplishment of the inspections and services. These services are arranged to facilitate inspection and conserve the time of the driver and are not necessarily in the same numerical order as shown on W. D. Form No. 48. The item numbers, however, are identical with those shown on that form.

d. The general inspection of each item applies also to any supporting member or connection, and generally includes a check to see whether the item is in good condition, correctly assembled, secure, or excessively worn.

(1) The inspection for "good condition" is usually an external visual inspection to determine whether the unit is damaged beyond safe or serviceable limits. The term "good condition" is explained further by the following: Not bent or twisted, not chafed or burned, not broken or cracked, not bare or frayed, not dented or collapsed, not torn or cut.

3/4-TON 4 x 4 TRUCK (DODGE)

(2) The inspection of a unit to see that it is "correctly assembled" is usually an external visual inspection to see whether it is in its normal assembled position in the vehicle.

(3) The inspection of a unit to determine if it is "secure" is usually an external visual examination, a wrench, hand-feel, or a pry-bar check for looseness. Such an inspection should include any brackets, lock washers, lock nuts, locking wires, or cotter pins, used in assembly.

(4) "Excessively worn" will be understood to mean worn close-to or beyond serviceable limits, and likely to result in a failure if not replaced before the next scheduled inspection.

e. Any defects or unsatisfactory operating characteristics beyond the scope of first echelon to correct must be reported at the earliest opportunity to the designated individual in authority.

19. BEFORE-OPERATION SERVICE.

a. This inspection schedule is designed primarily as a check to see that the vehicle has not been damaged, tampered with, or sabotaged, since the After-operation Service was performed. Various combat conditions may have rendered the vehicle unsafe for operation and it is the duty of the driver to determine whether or not the vehicle is in condition to carry out any mission to which it is assigned. This operation will not be entirely omitted, even in extreme tactical situations.

b. **Procedures.** Before-operation Service consists of inspecting items listed below according to the procedure described, and correcting or reporting any deficiencies. Upon completion of the service, results should be reported promptly to the designated individual in authority.

(1) **ITEM 1, TAMPERING AND DAMAGE.** Look for any injury to vehicle, its accessories or equipment, caused by tampering or sabotage, collision, falling debris, or shell fire, since parking. Look within engine compartment for evidence of these conditions, and for loosened or damaged engine accessories or drive belt, loose fuel, oil or coolant lines, or disconnected control linkage.

(2) **ITEM 2, FIRE EXTINGUISHER.** See that extinguisher is securely mounted and not damaged, and look for evidence of opened operating valve or leakage.

(3) **ITEM 3, FUEL, ENGINE OIL, AND COOLANT SUPPLY.** Check supply of fuel, oil and coolant and add as necessary to bring to proper levels. *NOTE: Any appreciable drop in levels since After-operation Service should be investigated and cause corrected or reported.* During freezing weather when antifreeze solution is in use, if any appreciable addition of water is needed, antifreeze value should be tested by second echelon and added if necessary. Be sure spare fuel, oil and water cans are full and securely mounted.

(4) **ITEM 4, ACCESSORIES AND DRIVES.** Examine units, such as carburetor, generator, cranking motor, fan, and air cleaners for

FIRST ECHELON PREVENTIVE MAINTENANCE SERVICES

looseness, damage or leaks. Be sure drive belt is in good condition and has approximately $\frac{1}{2}$ inch finger pressure deflection.

(5) **ITEM 6, LEAKS (GENERAL).** Look on ground and under vehicle and within engine compartment for leaks, particularly at fuel tanks and lines, crankcase and oil filters, radiator, water pump, water lines and connections, brake fluid lines, shock absorbers, and all gear cases. Trace any leaks found to their source, and correct or report them.

(6) **ITEM 7, ENGINE WARM-UP.** Start engine, noting any tendency toward hard starting. Observe action of cranking motor, particularly if it has adequate cranking speed, and engages, and disengages without unusual noise when in operation. Set hand throttle so engine runs at fast idle, and during warm-up proceed with following Before-operation Services. **NOTE:** *If oil pressure is not evident in 30 seconds, stop engine and investigate.*

(7) **ITEM 8, CHOKE.** When starting engine, check operation of choke. As engine warms up, reset choke as required for engine to run smoothly and to prevent overchoking and oil dilution.

(8) **ITEM 9, INSTRUMENTS.**

(a) **Oil Gage.** Pressure above 30 miles per hour should be 30 to 50 pounds; at idle speed, at least 15 pounds.

(b) **Ammeter.** Ammeter should show a high positive (+) charge immediately after starting engine at fast idle. High charge readings may continue if battery is low or electrical load heavy.

(c) **Engine Temperature Gage.** Reading should increase gradually after starting, to normal operating range, 160°F to 185°F. Maximum safe operating temperature 200°F.

(d) **Fuel Gage.** Ordinarily, tank will be filled after operation and gage should register "full."

(9) **ITEM 10, HORN AND WINDSHIELD WIPERS.** If tactical situation permits, test horn for proper operation and tone. Test wiper operation and observe if blades contact glass evenly and arms travel through full stroke. Inspect for damage.

(10) **ITEM 11, GLASS AND REAR-VISION MIRROR.** Clean all glass and inspect for damage. Aim rear-vision mirror and tighten if loose.

(11) **ITEM 12, LAMPS (LIGHTS) AND REFLECTORS.** Clean all lamps and warning reflectors. Examine them for looseness or damage. If tactical situation permits, check operation of all lights.

(12) **ITEM 13, WHEEL AND FLANGE NUTS.** See that all wheel side ring, mounting, and axle flange nuts are present and secure.

(13) **ITEM 14, TIRES.** Pressure 40 pounds (maximum) cool. Inspect tires for damage, and remove any objects lodged in carcass.

(14) **ITEM 15, SPRINGS AND SUSPENSIONS.** Inspect springs and shock absorbers to see that they are secure and not damaged. Examine shocks for leaks.

(15) **ITEM 16, STEERING LINKAGE.** Inspect gear case for lubricant leaks and all linkage connections for looseness or damage.

3/4-TON 4 x 4 TRUCK (DODGE)

(16) ITEM 17, FENDERS AND BUMPERS. Inspect these units for looseness or damage.

(17) ITEM 18, TOWING CONNECTIONS. Inspect all towing devices for looseness or damage. Examine pintle to be sure it operates freely and locks securely.

(18) ITEM 19, BODY LOAD AND TARPS. Inspect cab, body, and tarpaulins, for looseness and damage. See that any cargo is secure and properly distributed; that doors, windows, and windshield, operate properly and latch securely, and that stretchers or other special ambulance equipment is properly stowed.

(19) ITEM 20, DECONTAMINATOR. Be sure unit is present, fully charged, and secure.

(20) ITEM 21, TOOLS AND EQUIPMENT. Be sure all items are present, serviceable, and properly mounted or stowed.

(21) ITEM 22, ENGINE OPERATION. Before vehicle is put in motion, be sure oil gage registers 30 to 50 pounds at normal operating speed. Accelerate and decelerate and listen for any unusual vibration or noise. Note any unsatisfactory operating characteristics or excessive exhaust smoke.

(22) ITEM 23, DRIVER'S PERMIT AND FORM 26. Driver must have his operator's permit on his person. Check to see that Standard Accident Report Form No. 26, operator's manual, Lubrication Guide and W. D. Form No. 478 are present in vehicle, legible, and properly stowed.

(23) ITEM 25, DURING-OPERATION CHECK. The During-operation Services and observations start immediately the vehicle is put in motion as follows.

20. DURING-OPERATION SERVICE.

a. While vehicle is in motion, listen for any unusual sounds that may indicate trouble. Be on the alert to detect any odor of overheated components or units such as generator, brakes or clutch, fuel vapor from a leak in fuel system, exhaust, gas, smoke, or other signs of trouble. Any time the brakes are used, gears shifted, or vehicle turned, consider this a test and notice any unsatisfactory or unusual performance. Watch the instruments constantly.

b. Procedures. During-operation Services consist of observing items listed below according to the procedures following each item, and investigating any indications of serious trouble. Notice minor deficiencies to be corrected or reported at earliest opportunity, usually next scheduled halt.

(1) ITEM 27, FOOT AND HAND BRAKES. Foot brakes should stop vehicle smoothly on about $\frac{1}{2}$ of the total pedal travel. Pedal should have $\frac{1}{16}$ inch free travel before meeting resistance, and return to off position immediately foot pressure is released. Hand brake should lock and hold vehicle on a reasonable incline, leaving $\frac{1}{4}$ to $\frac{1}{3}$ of ratchet travel in reserve.

FIRST ECHELON PREVENTIVE MAINTENANCE SERVICES

(2) ITEM 28, CLUTCH. Clutch should release fully to allow easy gear shifting, must not grab during engagement, or slip when fully engaged under load. Pedal should have $1\frac{1}{8}$ inch free travel before meeting resistance and must release fully without striking bottom of floor plate.

(3) ITEM 29, TRANSMISSION. Gears should shift easily and not creep out of mesh during operation.

(4) ITEM 30, TRANSFER. Transfer unit should shift easily and not creep out of mesh during operation.

(5) ITEM 31, ENGINE AND CONTROLS. Be on the alert for deficiencies in engine performance such as lack of usual power, misfiring or stalling, unusual noise or vibration, indications of overheating or excessive exhaust smoke. Observe if engine responds to all controls and if controls appear to be in proper adjustment, and not excessively loose or binding. NOTE: *If radio interference is reported during operation, the driver will cooperate with the radio operator in locating its sources (par. 42).*

(6) ITEM 32, INSTRUMENTS. Observe readings of all instruments frequently during operation to be sure units to which they apply are functioning satisfactorily.

(a) *Oil Pressure Gage.* Reading should show 30 to 50 pounds above 30 miles per hour.

(b) *Ammeter.* During operation with all lamps and accessories turned off, ammeter should indicate a positive (+) charge above 20 miles per hour, or with fully charged battery it may register zero. Investigate or report excessive negative (-) readings.

(c) *Engine Temperature Gage.* Reading should increase gradually during warm-up to normal operating range, 160°F to 185°F. Maximum safe temperature. 200°F.

(d) *Speedometer.* Pointer should indicate actual vehicle speed and odometer should register total accumulated mileage.

(7) ITEM 33, STEERING GEAR. Note any indication of looseness or binding, pull to one side, wandering, shimmy, wheel tramp, or unusual noise.

(8) ITEM 34, RUNNING GEAR. Be on alert for any unusual operating characteristics or noise from wheels, axles, or suspension units, that might indicate looseness or damage, or under-inflated tires.

(9) ITEM 35, BODY. Note any noise or abnormal condition that might indicate shifting, loose top tarpaulin or curtains, loose or damaged doors, hardware, load, or mounted body attachments.

21. AT-HALT SERVICE.

a. At-halt Services may be regarded as minimum maintenance procedures and should be performed under all tactical conditions even though more extensive maintenance services must be slighted or omitted altogether.

b. **Procedures.** At-halt Services consist of investigating any deficiencies noted during operation, inspecting items listed below ac-

¾-TON 4 x 4 TRUCK (DODGE)

ording to the procedures following the items, and correcting any deficiencies found. Deficiencies not corrected should be reported promptly to the designated individual in authority.

(1) **ITEM 38, FUEL, OIL, AND WATER SUPPLY.** See that fuel, engine oil, and coolant supply, is adequate to operate the vehicle to the next stop. Install all caps securely. If engine is hot, fill radiator slowly while engine is running at a fast idle.

(2) **ITEM 39, TEMPERATURES: HUBS, BRAKE DRUMS, TRANSFER, TRANSMISSION, AND AXLES.** Place hand cautiously on each brake drum and wheel hub to see if it is abnormally hot. Inspect transfer case, transmission and axle housings for excessive lubricant leakage.

(3) **ITEM 40, AXLE AND TRANSFER VENTS.** Inspect vents for damage or clogging.

(4) **ITEM 41, PROPELLER SHAFTS.** Inspect all drive shafts and universal joints for any foreign matter wound around shafts or joints.

(5) **ITEM 42, SPRINGS AND SUSPENSIONS.** Inspect for broken or shifted spring leaves or damaged spring parts.

(6) **ITEM 43, STEERING LINKAGE.** Examine all steering control mechanism and connections for looseness or damage. Investigate any unusual condition noted during operation.

(7) **ITEM 44, WHEEL AND FLANGE NUTS.** See that all wheel side ring mounting, and axle flange nuts are present and secure.

(8) **ITEM 45, TIRES.** Inspect all tires for under-inflation or damage. Remove objects lodged in carcasses. See that spare is inflated and secure in carrier.

(9) **ITEM 46, LEAKS (GENERAL).** Look under vehicle and within engine compartment for indications of leakage of fuel, oil, or coolant. Trace any found to their source and correct or report them.

(10) **ITEM 47, ACCESSORIES AND BELTS.** Examine all accessible units for looseness or damage. Be sure fan belt is adjusted to ½ inch finger pressure deflection. If radio interference was reported, examine the wiring, and noise suppression units in engine compartment for loose connections or mountings. Give special attention to resistor-suppressors at spark plugs and distributor.

(11) **ITEM 48, AIR CLEANERS.** If operating under extremely dusty or sandy condition, inspect air cleaner and breather cap to see that they are in condition to deliver properly. Service as necessary.

(12) **ITEM 49, FENDERS AND BUMPER.** Inspect front and rear bumpers and fenders for looseness or damage.

(13) **ITEM 50, TOWING CONNECTIONS.** Inspect all connections for looseness or damage. Be sure locking devices are secure.

(14) **ITEM 51, BODY, LOAD, AND TARPAULINS.** Inspect all items for damage, or indications of looseness or shifting.

(15) **ITEM 52, GLASS.** Clean all windshield, door, window, mirror, light, and warning reflector glass and inspect for damage.

FIRST ECHELON PREVENTIVE MAINTENANCE SERVICES**22. AFTER-OPERATION AND WEEKLY SERVICE.**

a. After-operation Servicing is particularly important because at this time the driver inspects his vehicle to detect any deficiencies that may have developed and corrects those he is permitted to handle. He should report promptly to the designated individual in authority the results of his inspection. If this schedule is performed thoroughly, the vehicle should be ready to roll again on a moment's notice. The Before-operation Service, with a few exceptions, is then necessary only to ascertain whether the vehicle is in the same condition in which it was left upon completion of the After-operation Service. The After-operation Service should never be entirely omitted even in extreme tactical situations, but may be reduced to the bare fundamental services outlined for the At-halt Service if necessary.

b. **Procedures.** When performing the After-operation Service the driver must remember and consider any irregularities noticed during the day in the Before-operation, During-operation, and At-halt Services. The After-operation Service consists of inspecting and servicing the following items. Those items of the After-operation Service that are marked by an asterisk (*) require additional weekly services, the procedures for which are indicated in step (b) of each applicable item.

(1) **ITEM 55, ENGINE OPERATION.** Accelerate and decelerate engine and note any tendency to miss or back-fire. Listen for any unusual noise or vibration that may indicate worn or inadequately lubricated parts, loose mountings, incorrect fuel mixture or faulty ignition. Note any unusual exhaust smoke. Investigate and correct or report any deficiencies noted during operation.

(2) **ITEM 56, INSTRUMENTS.** Check all instruments to be sure they register and indicate correct engine performance. Inspect them for looseness or damage. Stop engine.

(3) **ITEM 54, FUEL, OIL, AND WATER SUPPLY.** Fill fuel tank and check fuel gage for fuel indication. Check crankcase oil and coolant supply and add as necessary to bring to correct level. In freezing weather if any appreciable amount of coolant is necessary, have antifreeze value checked and add sufficient to protect cooling system against freezing. Do not add coolant while engine is too hot. Fill all spare fuel, oil, and water cans, if supply has been used.

(4) **ITEM 57, HORN AND WINDSHIELD WIPERS.** Inspect to see if these items are loose or damaged. If tactical conditions permit, test horn for proper operation and tone.

(5) **ITEM 58, GLASS AND REAR VISION MIRROR.** Clean all glass and inspect for looseness or damage.

(6) **ITEM 59, LAMPS (LIGHTS) AND REFLECTORS.** Inspect for looseness or damage. If tactical situation permits, test all lamps and switches for proper operation. Clean lenses.

(7) **ITEM 60, FIRE EXTINGUISHER.** Inspect for looseness or damage and full charge. If extinguisher has been in use or valves opened, report for refill or exchange.

3/4-TON 4 x 4 TRUCK (DODGE)

(8) ITEM 61, DECONTAMINATOR. Inspect for looseness or damage and full charge; if used, report for refill or exchange.

(9) ITEM 62, *BATTERY AND VOLTMETER.

(a) Inspect battery to see that it is clean, secure, and not leaking or damaged. See that filler caps are fingertight.

(b) *Weekly.* Clean top of battery. If terminal connections or posts are corroded, clean and apply fresh, thin coating of grease and tighten. Check level of solution and add water if required. During freezing weather, do not add water until just before operation. Battery and carrier should be secure, and battery not bulging or leaking. Tighten any loose mountings cautiously so as not to damage the battery case.

(10) ITEM 63, ACCESSORIES AND BELTS. Inspect units such as carburetor and air cleaner, generator, starting motor, fan, water pump, distributor, regulator unit, and oil filter, for looseness, damage, or leakage. Check condition and adjustment of fan belt. Should have 1/2 inch finger pressure deflection. Investigate and correct or report any deficiencies noted during operation.

(11) ITEM 64, ELECTRICAL WIRING. Inspect all ignition and accessible low voltage wiring for looseness or damage; wipe off grease or moisture. Be sure all wiring is supported, so as not to chafe against other vehicle parts. Examine resistor-suppressors at spark plugs and distributor to see if they are scorched or damaged.

(12) ITEM 65, *AIR CLEANER AND BREATHER CAP.

(a) Inspect for looseness or damage. Examine oil in reservoirs for correct level and excessive dirt. When operating in sandy or dusty conditions, clean and service engine air cleaner, crankcase ventilator breather cap, and ventilator outlet filter element as often as necessary.

(b) *Weekly.* Remove engine air cleaner and crankcase breather reservoirs and elements, wash in dry-cleaning solvent, refill oil-bath type reservoirs with clean oil and install securely. On element type ventilators, wash in dry-cleaning solvent, dry, dip in clean engine oil, and install. Be sure all gaskets seal properly and that joints and connections are secure.

(13) ITEM 66, *FUEL FILTER.

(a) Inspect for looseness, damage, and fuel leaks.

(b) *Weekly.* Remove drain plug and drain off all accumulated dirt and water. If draining shows excessive dirt or water, remove bowl and clean filter element in dry-cleaning solvent. Do not disassemble element. Replace all unserviceable gaskets. NOTE: *If excessive water is present, report to higher echelon for cleaning of fuel tank.*

(14) ITEM 67, ENGINE CONTROLS. Examine all engine operating control linkage for looseness, damage, excessive wear, and adequate lubrication.

(15) ITEM 68, *TIRES.

(a) Examine all tires, including spares, for damage and excessive wear. Remove all embedded foreign matter, such as nails, glass, or

FIRST ECHELON PREVENTIVE MAINTENANCE SERVICES

stones from carcasses. Check for low pressures and proper position of valve stem and presence of valve caps. Inflate to 40 pounds pressure as needed (cool).

(b) *Weekly*. Replace badly worn or otherwise unserviceable tires. Serviceable tires which show abnormal wear should be relocated to other wheels to even wear. Apparent mechanical deficiencies causing such wear should be reported for attention by higher echelon.

(16) **ITEM 69, SPRINGS AND SUSPENSIONS**. Inspect for looseness or damage, abnormal spring sag, shifted spring leaves, and shock absorber leakage. Investigate any noise or unusual condition noted during operation.

(17) **ITEM 70, STEERING LINKAGE**. Inspect for looseness, damage, and proper lubrication. Investigate any unusual operating condition noted during operation.

(18) **ITEM 71, PROPELLER SHAFTS**. Inspect all drive shafts and universal joints for looseness or damage and excessive oil leaks. Remove any foreign material wound around shafts or joints.

(19) **ITEM 73, *AXLE AND TRANSFER VENTS**.

(a) See that all axle housing and transfer case vents are present, in good condition and clean. Inspect for indications of excessive lubricant leakage from vents.

(b) *Weekly*. Remove accessible vents, clean out passages and install securely.

(20) **ITEM 73, LEAKS (GENERAL)**. Look in engine compartment and under vehicle for indications of fuel, engine oil, coolant, shock absorber or brake fluid, or gear oil leaks.

(21) **ITEM 74, GEAR OIL LEVELS**. Check gear oil levels in differentials, transfer case, transmission and steering gear housing, and report if low. Correct levels are from lower edge of filler hole (hot) to $\frac{1}{2}$ inch below (cold).

(22) **ITEM 76, FENDERS AND BUMPERS**. Inspect front and rear fenders and bumpers for looseness or damage.

(23) **ITEM 77, TOWING CONNECTIONS**. Inspect towing hooks, pintle hook and lock pins and chains for looseness, excessive wear or damage.

(24) **ITEM 78, BODY, LOAD, AND TARPS**. Inspect cab and body carefully for damage or loose parts. Examine top tarpaulin and side or end curtains for worn spots or other damage, and see that they are secure. See that any cargo is secure and properly distributed. Inspect doors or windows and their hardware to see if they are in good condition, and securely mounted, and that they operate properly.

(25) **ITEM 79, *WINCH**.

(a) Examine winch assembly for looseness or damage and excessive oil leaks at worm gear housing. See that winch drive shaft shear pin is secure. Be sure sliding clutch operates freely and locks securely.

(b) *Weekly*. If vehicle has been operated in deep water, sample lubricant for contamination. If water is present, report condition.

3/4-TON 4 x 4 TRUCK (DODGE)

Pull the vehicle up a steep bank with the winch. Release engine clutch; if vehicle starts to back down, the brake needs adjusting. If winch cable is dry or wound unevenly, unwind entire length, clean with thin oil or kerosene, rewind evenly on winch drum, applying a thin coat of engine or gear oil while winding, and secure cable chain and hook securely to front tow hooks. NOTE: *Clean, used oil is satisfactory.*

(26) ITEM 82, *TIGHTENING.

(a) Tighten any mounting or external assembly nuts or screws where inspection of vehicle has indicated the necessity.

(b) *Weekly.* Tighten wheel side ring, mounting and axle flange nuts and cap screws; spring U-bolts, shackles and rebound clips; universal joint companion flanges; engine mountings, transfer case mountings; steering arms, towing connections, or any other mounting or assembly nuts or screws that inspection or experience indicates are necessary on a weekly or mileage basis.

(27) ITEM 83, *LUBRICATE AS NEEDED.

(a) Lubricate all items such as shackles, hinges, latches, control linkage frictional joints, or any point where inspection has indicated oilcan or hand greasing is needed.

(b) *Weekly.* Lubricate all points of the vehicle indicated on the Lubrication Guide, figure 71, as needing lubrication on a weekly or a mileage basis.

(28) ITEM 84, *CLEAN ENGINE AND VEHICLE.

(a) Clean dirt and grease or oil drippings from inside cab and body, and from engine compartment and exterior of engine. Wipe off excess dirt and grease from entire vehicle.

(b) *Weekly.* Wash vehicle when possible or wipe off thoroughly. Inspect paint or camouflage pattern for rust or for bright spots which might cause light reflections. See that vehicle markings are legible unless covered for tactical reasons. CAUTION: *If vehicle is driven into water for washing, care must be taken to see that water or dirt does not get into wheel bearings, gear cases or brakes, or on electrical units or wiring.*

(29) ITEM 85, *TOOLS AND EQUIPMENT.

(a) Check vehicle stowage and tool lists to see that all items are present. Inspect items to see that they are in good condition and properly mounted or stowed (pars. 25 and 26).

(b) *Weekly.* Clean all tools and equipment of rust or dirt, and apply preservative where necessary, when possible. See that tools with cutting edges are sharp and properly protected and that all items are securely mounted or stowed.

Section VII

LUBRICATION

	Paragraph
Introduction	23
Lubrication Guide	24

23. INTRODUCTION.

a. Lubrication is an essential part of preventive maintenance, determining to a great extent the serviceability of parts and assemblies.

24. LUBRICATION GUIDE.

a. Lubrication instructions for this materiel are consolidated in a Lubrication Guide (fig. 32). These specify the points to be lubricated, the periods of lubrication, and the lubricant to be used. In addition to the items on the Guide, other small moving parts, such as hinges and latches, must be lubricated at frequent intervals.

b. **Supplies.** In the field it may not be possible to supply a complete assortment of lubricants called for by the Lubrication Guide to meet the recommendations. It will be necessary to make the best use of those available, subject to inspection by the officer concerned, in consultation with responsible ordnance personnel.

c. **Lubrication Notes.** The following notes apply to the Lubrication Guide (fig. 32). Figures 33 through 38 illustrate in detail various points to be lubricated. All note references in the Guide itself (fig. 32) are to the subparagraph below having the corresponding number:

(1) **FITTINGS.** Clean before applying lubricant. Lubricate until new lubricant is forced from the bearing, unless otherwise specified. **CAUTION:** *Lubricate chassis points after washing truck.*

(2) **INTERVALS.** Intervals indicated are for normal service. For extreme conditions of speed, heat, water, sand, mud, snow, rough roads, dust, etc., reduce interval by one-third or one-half, or more, if conditions warrant.

(3) **CLEANING.** Dry-cleaning solvent or Diesel fuel oil will be used to clean or wash all parts. Use of gasoline for this purpose is prohibited. All parts will be thoroughly dry before relubrication.

(4) **AIR CLEANERS.** Daily, check level and refill oil reservoir of engine air cleaner to bead level with used crankcase oil or OIL, engine, SAE 30 above +32°F and SAE from +32°F to 0°F. From 0°F to -40°F use FLUID, shock-absorber, light. Below -40°F remove oil and operate dry. Every 1,000 miles, daily under extreme dust conditions, remove and wash all parts. Every 1,000 miles, wash crankcase breather pipe air cleaner and ventilator outlet pipe air cleaner (located on right rear side of engine) and saturate filter element with used crankcase oil or OIL, engine, SAE 30 above +32°F and SAE 10 from +32°F to 0°F. Drain off excess oil before installing. From 0°F to -40°F use FLUID, shock-absorber, light. Below -40°F wash element and replace dry.

3/4-TON 4 x 4 TRUCK (DODGE)

Interval • Lubricant
1 CG Winch Drum and Shaft Bearings

Serviced From Under Hood

- 1 WP Water Pump
- 1 OE Generator (12 volt only)
- 6 OE (6 to 8 drops)(Note 18)
- 6 Front Axle Diff. Drain (Reached from under truck)
- D OE (Drain and refill)(Note 7)
- D OE Crankcase Fill (See Table)(Note 5)
- 6 OE Distributor (Note 12)
- 1 OE Distributor Shaft (6 to 8 drops)
- W GO Front Axle Diff. Fill and Level (Reached from under truck)
- 6 OE Air Cleaner (Check level)(Note 4)
- D Crankcase Level (Check level)
- 1 Oil Filter (Drain)(Note 6)
- 1 CG Universal Joint (Reached from under truck)(Note 10)
- 6 OE Cranking Motor
- GO Steering Gear (Fill to 1/2 in. from top)
- 1 HB Brake Master Cylinder
- 6 Transmission Drain (Drain and refill)(Note 7)
- W GO Transmission Fill and Level (Check level)(Note 7)
- 1 CG Slip Joints (Note 10)
- 1 CG Universal Joints (All models except ambulance reached through cover in cab floor)(Note 10)

CAUTION—Lubricate Dotted Arrow Points on Both Sides. Points on Opposite Side are indicated by Dotted Short-Shaft Arrows.

Lubricant • Interval

- Winch Worm Housing Level W (Check level)
- Winch Worm Housing Drain 6 (Drain and refill)(Note 7)
- Winch Worm Housing Fill GO W (Check level)(Note 7)
- Winch Clutch (Clean and oil) OE 1
- Spring Shackle CG 1
- Winch Universal Joint and Propeller Shaft Yoke CG 1
- Shock Absorber (Note 8) SA 6
- Universal Joint and Steering Knuckle Bearings (Note 9) CG 1
- Front Wheel Bearings (Remove, clean and repack)(Note 13) WB 6
- Tie Rod CG 1
- Drag Link CG 1
- Crankcase Drain 1 (Drain and refill)(Note 5)
- Spring Bolt CG 1
- Winch Universal and Slip Joints (Note 10) CG 1
- Clutch and Brake Pedals CG 1
- Clutch Release Fork Bushing OE 1

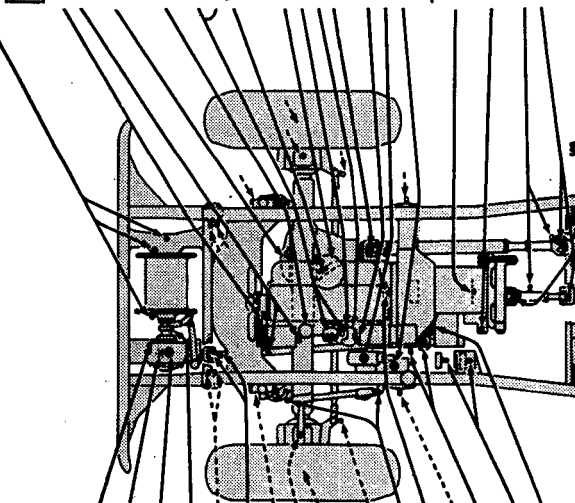

M-6256—First Revise—12-8-43—Q-979

RA PD 312581

LUBRICATION

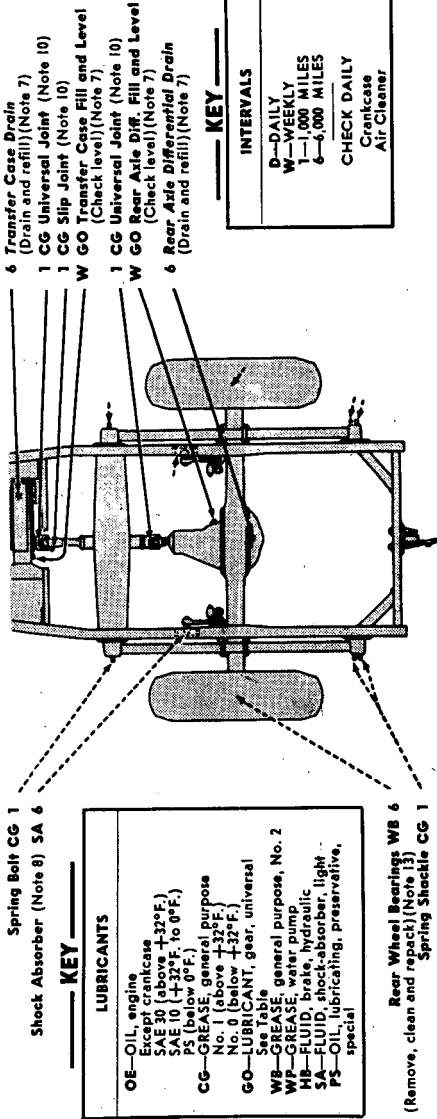

59

TABLE OF CAPACITIES AND LUBRICANTS TO BE USED

UNIT	CAPACITY (Approx.)	LOWEST EXPECTED AIR TEMPERATURE	
		+32° F. and above	+32° F. to 0° F. Below 0° F.
Crankcase	5 qt.	OE SAE 30	OE SAE 10 Refer to OFSB 6-11
Transmission (With Power Take-off)	2 3/4 qt. 3 1/2 qt.	GO SAE 90	GO Grade 75
Transfer Case	2 qt.	GO SAE 90	GO Grade 75
Differentials (each)	2 1/4 qt.		
Winch Worm Housing	1 qt.		

12-18-43
Supersedes all previous instructions.

RA PD 312581B

M-6256—First Revise—12-8-43—0079

Figure 32—Lubrication Guide

3/4-TON 4 x 4 TRUCK (DODGE)

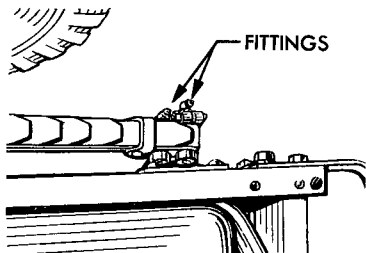

8 FITTINGS (2 EACH SHACKLE).
PRESSURE GUN.
LUBRICATE FROM UNDER VEHICLE.
SPRING SHACKLES

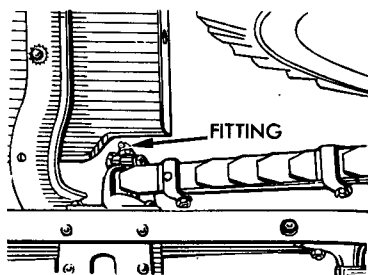

4 FITTINGS (1 EACH SPRING)
PRESSURE GUN.
LUBRICATE FROM UNDER VEHICLE.
SPRING BOLTS

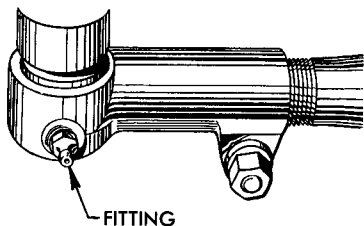

2 FITTINGS (1 EACH END).
PRESSURE GUN.
LUBRICATE FROM UNDER VEHICLE.

TIE ROD ENDS

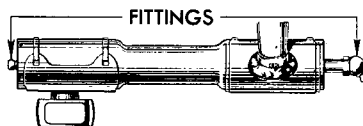

2 FITTINGS (1 EACH END).
PRESSURE GUN.
LUBRICATE FROM UNDER VEHICLE.

STEERING DRAG LINK

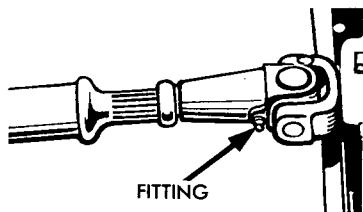

3 FITTINGS (1 EACH SHAFT).
5 FITTINGS IF EQUIPPED WITH
WINCH (1 EACH END OF
WINCH DRIVE SHAFT).
PRESSURE GUN.
LUBRICATE FROM UNDER VEHICLE.

PROPELLER SHAFT SPLINE YOKE

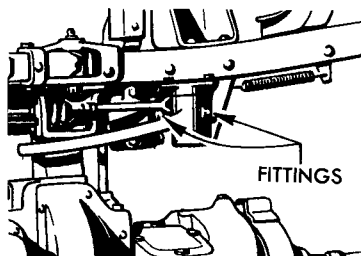

2 FITTINGS (1 EACH PEDAL).
PRESSURE GUN.
LUBRICATE FROM UNDER VEHICLE.

CLUTCH AND BRAKE PEDALS

RA PD 58345

Figure 33—Lubrication Fittings

LUBRICATION

(5) **CRANKCASE.** Drain only when engine is hot. To aid in complete draining, the front end of the truck should be slightly higher than the rear. Refill to "FULL" mark on gage. Run engine a few minutes and recheck oil level. **CAUTION:** *Level should be at "running level," or center mark between "FULL" and "½ FULL" marks on gage. Be sure pressure gage indicates oil is circulating.*

(6) **OIL FILTER.** Every 1,000 miles, drain sediment. Every 6,000 miles or more often if filter becomes clogged, drain filter, clean inside and renew element. Run engine a few minutes, check crankcase level and add OIL, engine, to "FULL" mark on gage (SAE 30 above +32°F to 0°F, below 0°F, refer to OFSB 6-11).

(7) **GEAR CASES.** Weekly, check level with truck on level ground and, if necessary, add lubricant to ½ inch below plug level when cold or to plug level when hot. Winch gear case and steering gear case will be filled to plug level at all times. Drain and refill at intervals indicated on Guide. Drain only after operation. Keep vents clean.

(8) **SHOCK ABSORBERS.** To fill, disconnect linkage at lower end. Clean surface around fill plug. Remove plug and fill to level with FLUID, shock-absorber, light. Pump arm up and down to expel air. Repeat this procedure until no more fluid can be added. Install plug and connect linkage.

(9) **UNIVERSAL JOINTS (FRONT WHEELS).** With truck on level ground, remove plug at bottom of ball end of axle housing and lubricate through fitting at top of steering knuckle until lubricant comes out of bottom hole. Replace bottom plug. Every six months, disassemble, clean and repack each joint with one pound of lubricant before reassembling.

(10) **UNIVERSAL JOINTS AND SLIP JOINTS.** Apply GREASE, general purpose, No. 1 above +32°F and No. 0 below +32°F, to universal joints until it overflows at ends of cross and to slip joint until lubricant is forced from end of slip joint. If lubricant does not overflow at ends of all crosses, apply "C" clamp if available and tighten on bearings where lubricant appeared; then relubricate. This will cause lubricant to flow into all bearings.

(11) **BRAKE MASTER CYLINDER.** Every 1,000 miles, inspect level of brake fluid in reservoir. Add sufficient FLUID, brake, hydraulic, to bring level ½ inch from top of opening in reservoir. Report at once any excessive loss or leakage.

(12) **DISTRIBUTOR.** Every 6,000 miles, wipe distributor breaker cam lightly with GREASE, general purpose, No. 1 above +32°F and No. 0 below +32°F and lubricate breaker arm pivot and wick under rotor with one to two drops of OIL, engine, SAE 30 above +32°F, SAE 10 +32°F to 0°F; and OIL, lubricating, preservative, special, below 0°F.

(13) **WHEEL BEARINGS.** Remove bearing cone assemblies from hub and wash spindle and inside of hub. Inspect bearing races and replace if necessary. Wet the spindle and inside of hub and hub cap with GREASE, general purpose, No. 2, to a maximum thickness of

3/4-TON 4 x 4 TRUCK (DODGE)

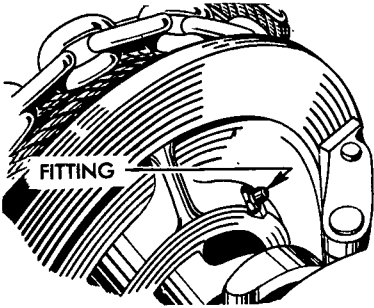

2 FITTINGS (1 EACH SIDE).
PRESSURE GUN.
LUBRICATE FROM FRONT OF VEHICLE.

WINCH DRUM BEARINGS

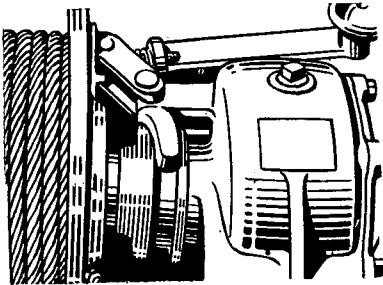

SLIDING SURFACE OF JAW CLUTCH
AND LINKAGE.
OIL CAN.
LUBRICATE FROM FRONT OF VEHICLE.

WINCH CLUTCH

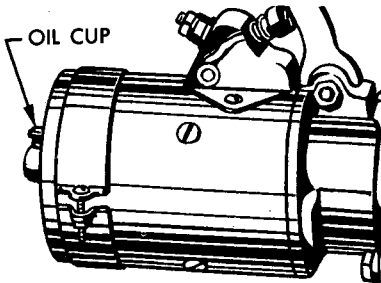

OIL CUP.
OIL CAN.
LUBRICATE FROM UNDER
LEFT SIDE OF HOOD.

CRANKING MOTOR

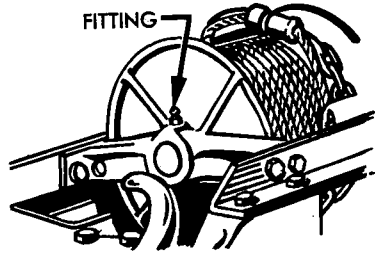

1 FITTING.
PRESSURE GUN.
LUBRICATE FROM ABOVE FRONT
OF VEHICLE.

WINCH SHAFT

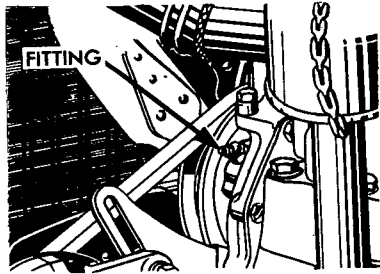

1 FITTING.
PRESSURE GUN.
LUBRICATE FROM UNDER
LEFT SIDE OF HOOD.

WATER PUMP

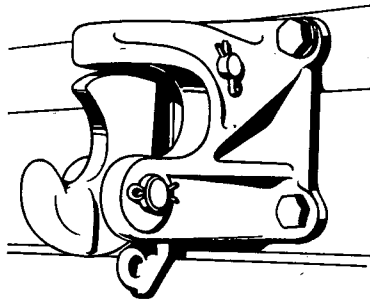

PINS AND CONNECTIONS.
OIL CAN.
LUBRICATE FROM REAR OF VEHICLE.

PINTLE HOOK RA PD 318325

Figure 34—Lubrication Fittings

LUBRICATION

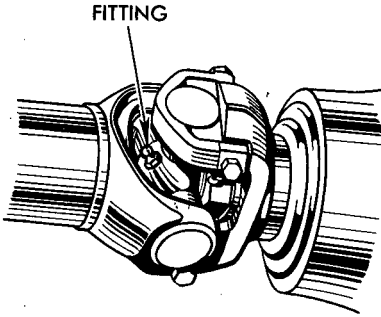

6 FITTINGS (1 EACH JOINT CROSS), 8 FITTINGS IF EQUIPPED WITH WINCH. PRESSURE GUN. LUBRICATE FROM UNDER VEHICLE. THE FRONT JOINT FITTING ON THE TRANSMISSION TO TRANSFER CASE SHAFT IS LUBRICATED THROUGH COVERED OPENING IN FLOOR OF FRONT COMPARTMENT, EXCEPT AMBULANCE.

UNIVERSAL JOINTS

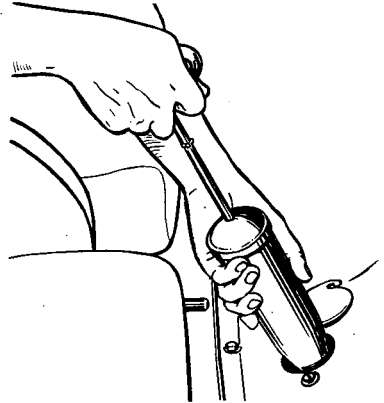

1 FITTING. PRESSURE GUN. LUBRICATE THROUGH COVERED OPENING IN FRONT COMPARTMENT FLOOR. LOOSEN COVER SCREWS AND SLIDE COVER FROM OPENING. SCREW DRIVER. RETURN COVER AND TIGHTEN SCREWS.

FRONT JOINT
(EXCEPT AMBULANCE)

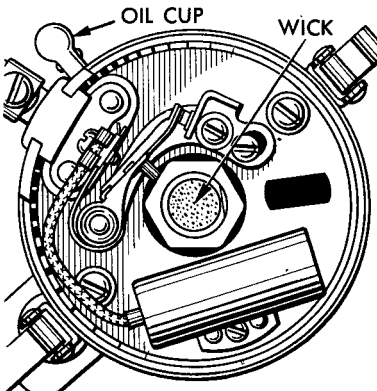

OIL CUP AND WICK. OIL CAN. LUBRICATE FROM UNDER LEFT SIDE OF HOOD. REMOVE CAP AND ROTOR AND APPLY 2 OR 3 DROPS OF ENGINE OIL TO WICK BENEATH ROTOR. SEE THAT NO OIL IS ON OR NEAR BREAKER POINTS. CLEAN VENT HOLE IN CAP.

DISTRIBUTOR

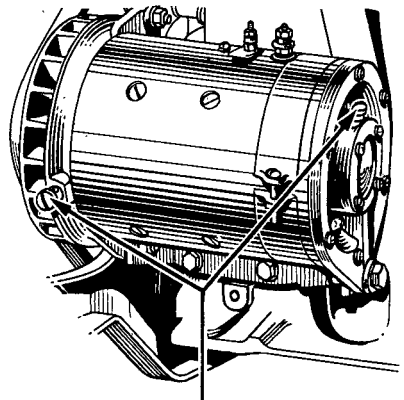

OIL CUPS

2 OIL CUPS (1 ON EACH END). OIL CAN. LUBRICATE FROM UNDER LEFT SIDE OF HOOD.

GENERATOR (12. VOLT)

RA PD 58347

Figure 35—Lubrication Fittings

3/4-TON 4 x 4 TRUCK (DODGE)

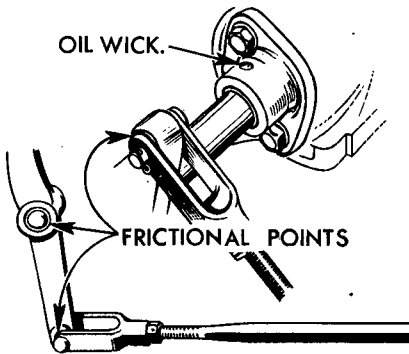

TRANSFER CASE SHIFT, HAND BRAKE CONTROL, FOOT PEDAL LINKAGE AND CLUTCH RELEASE FORK BUSHING WICK. OIL CAN. LUBRICATE FROM UNDER VEHICLE. OIL CLEVIS PINS, ROD CONNECTIONS AND WICK IN CLUTCH RELEASE FORK FLANGE AT LEFT SIDE OF CLUTCH HOUSING.

LINKAGE

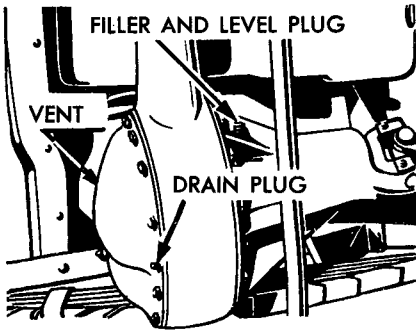

FILLER HOLE (REMOVE PLUG). WRENCH, OPEN END 5/8-IN. PUMP GUN. LUBRICATE FROM UNDER VEHICLE. REMOVE AND CLEAN VENT. WRENCH, OPEN END 5/8-IN. DRAIN AND FLUSH, REMOVE DRAIN PLUG. WRENCH, OPEN END 5/16-IN. INSTALL PLUGS AND VENT.

FRONT AND REAR AXLES

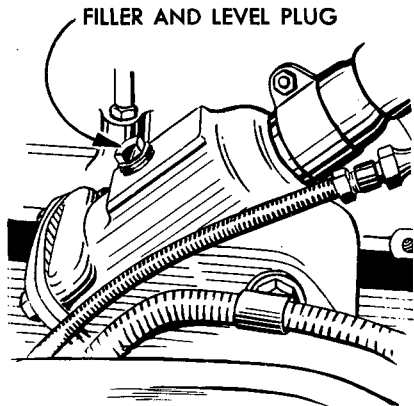

FILLER HOLE (REMOVE PLUG). WRENCH, OPEN END 5/8-IN. PUMP GUN. LUBRICATE FROM UNDER LEFT SIDE OF HOOD. INSTALL PLUG.

STEERING GEAR

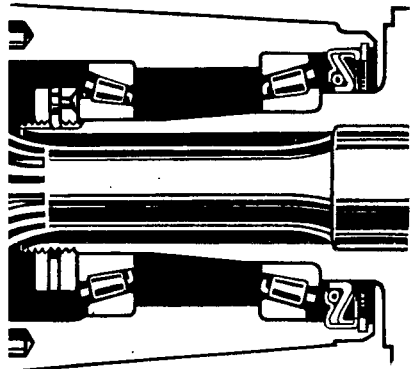

REMOVE HUB AND BEARINGS. WRENCHES, WHEEL BEARING ADJUSTING NUT AND OPEN END 5/8, 1/16 AND 3/8-IN. CLEAN AND REPACK. LUBRICATE FROM SIDES OF VEHICLE. ASSEMBLE AND ADJUST.

WHEEL BEARINGS

RA PD 58348

Figure 36—Lubrication Fittings

LUBRICATION

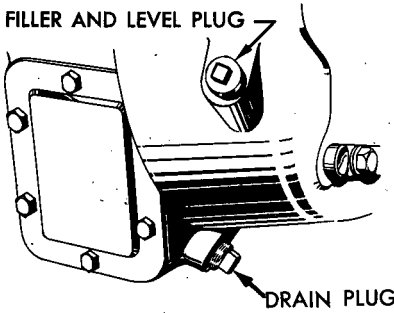

FILLER HOLE (REMOVE PLUG).
WRENCH, OPEN END $\frac{3}{8}$ -IN.
PUMP GUN.
LUBRICATE FROM UNDER VEHICLE.
DRAIN AND FLUSH, REMOVE DRAIN
PLUG.
WRENCH, OPEN END $\frac{3}{8}$ -IN.
INSTALL PLUGS.

TRANSMISSION

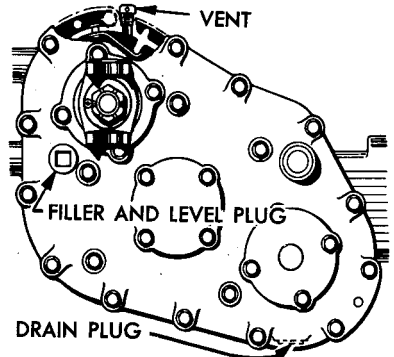

FILLER HOLE IN REAR OF CASE (RE-
MOVE PLUG).
WRENCH, OPEN END $\frac{3}{8}$ -IN.
PUMP GUN.
LUBRICATE FROM UNDER VEHICLE.
REMOVE AND CLEAN VENT.
PLIERS.
DRAIN AND FLUSH, REMOVE DRAIN
PLUG.
WRENCH, DRIVE END $\frac{3}{8}$ -IN.
INSTALL PLUGS AND VENT.

TRANSFER CASE

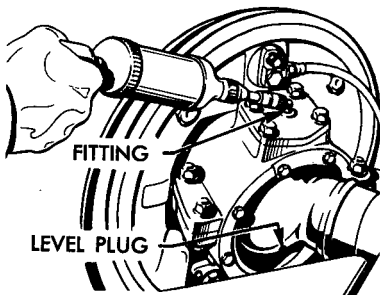

4 PLUGS (2 EACH JOINT), UNSCREW
PLUGS AND SCREW ANGLE FITTING
IN TOP HOLE IF TOP HOLE IS NOT
EQUIPPED WITH FITTING.
SCREW DRIVER AND WRENCH, OPEN
END $\frac{3}{16}$ -IN.
PRESSURE GUN.
LUBRICATE FROM UNDER VEHICLE.
INSTALL PLUGS.

FRONT AXLE UNIVERSAL

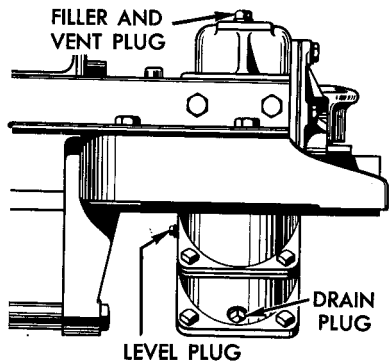

FILLER AND LEVEL HOLES (REMOVE
PLUGS).
WRENCHES, OPEN END, $\frac{1}{16}$ AND $\frac{3}{16}$ -IN.
PUMP GUN.
LUBRICATE FROM FRONT OF VEHICLE.
CLEAN VENT HOLE IN FILLER
PLUG.
TO DRAIN AND FLUSH, REMOVE DRAIN
PLUG.
WRENCH, OPEN END $\frac{3}{16}$ -IN.
INSTALL PLUGS.

WINCH HOUSING

RA PD 58349

Figure 37—Lubrication Fittings

3/4-TON 4 x 4 TRUCK (DODGE)

1/16 inch only to retard rust. Wash bearing cones and grease seals. Inspect and replace if necessary. Lubricate bearings with GREASE, general purpose, No. 2, with a packer or by hand, kneading lubricant into all spaces in the bearing. Use extreme care to protect bearings from dirt and immediately reassemble and replace wheel. The lubricant in the bearings is sufficient to provide lubrication until the next service period. Do not fill hub or hub cap. Any excess might result in leakage into the brake drum.

(14) WINCH CABLE. After each use, clean and oil with used crankcase oil or OIL, engine, SAE 30 above +32°F and SAE 10 from +32°F to 0°F and OIL, lubricating, preservative, special, below 0°F. Weekly, if cable has not been used, coat outer coils with used

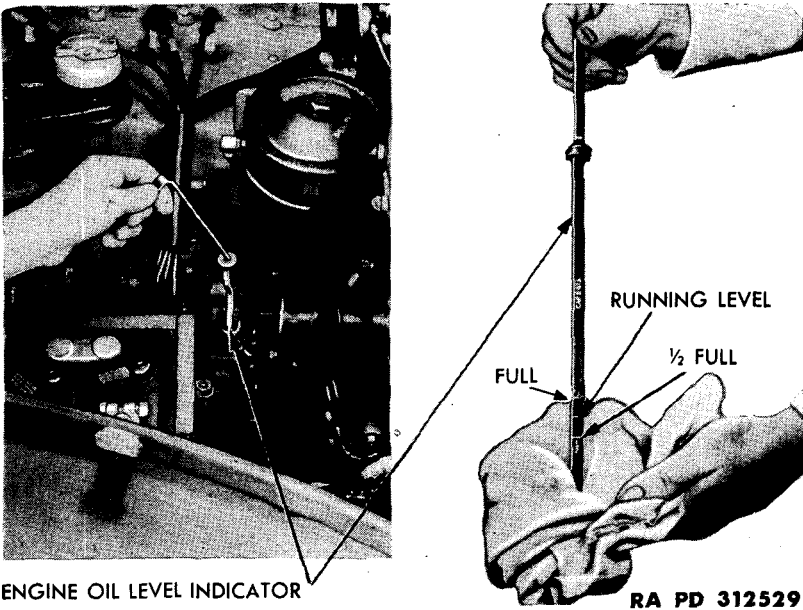

Figure 38—Oil Level Indicator

crankcase oil or OIL, engine, SAE 30 above +32°F and SAE 10 from +32°F to 0°F and OIL, lubricating, preservative, special, below 0°F. Monthly, unwind entire cable, clean and oil.

(15) CLUTCH PILOT BEARING. When clutch is disassembled for any other purpose, clean and repack with GREASE, general purpose, No. 2.

(16) OILCAN POINTS. Every 1,000 miles lubricate transfer case shift, hand brake control, foot pedal linkage, winch control linkage, pintle hook, hood and windshield hinges and locks, and ambulance rear folding step joints with OIL, engine, SAE 30 above +32°F; SAE 10 +32°F to 0°F and OIL, lubricating, preservative, special,

LUBRICATION

below 0°F. **CAUTION.** *Do not oil throttle control linkage.* Also coat door latches, hinges, wedges, checks and striker plates with **GREASE**, general purpose, No. 1 above +32°F and No. 0 below +32°F.

(17) **RUBBER BUSHINGS.** Every 1,000 miles, apply **FLUID**, brake, hydraulic, to shock absorber link bushings. **CAUTION:** *Do not use oil.*

(18) **POINTS REQUIRING NO LUBRICATION SERVICE.** These are the clutch release bearing, generator bearings (6-volt), and fan.

(19) **COLD WEATHER.** For lubrication and service below 0°F, refer to **OFSB 6-11.**

d. Reports and Records. If lubrication instructions are closely followed, proper lubricants used, and satisfactory results are not obtained, a report will be made to the ordnance officer responsible for the maintenance of the materiel. A complete record of lubrication servicing will be kept.

3/4-TON 4 x 4 TRUCK (DODGE)

Section VIII

TOOLS AND EQUIPMENT STOWAGE ON THE VEHICLE

Paragraph

Vehicle tools and equipment..... 25

25. VEHICLE TOOLS AND EQUIPMENT.

a. **Vehicle Tools.** The tools and equipment supplied with all vehicles are listed and illustrated in figure 40. Space for carrying tools and equipment is provided in each vehicle as follows:

(1) **WEAPON CARRIER, TELEPHONE MAINTENANCE, AND EMERGENCY REPAIR:** In space provided under front seats.

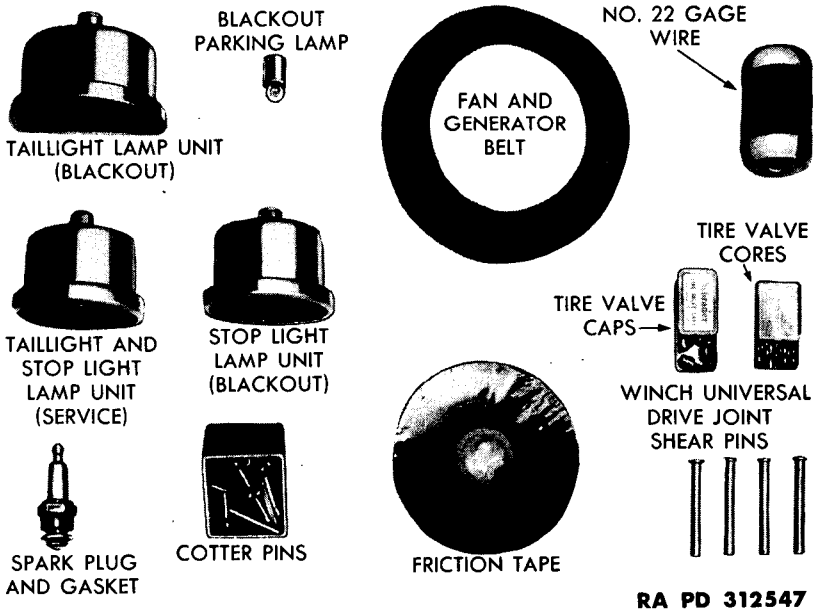

Figure 39—Spare Parts Kit

(2) **CARRYALL:** In the tool box built under the driver's seat. Store tire chains in the space provided to the rear of the right wheel housing.

(3) **AMBULANCE:** In the locker boxes along the right and left sides in the interior of the body.

(4) **COMMAND:** In the rear deck compartment.

b. **Spare Parts Kit.** Each vehicle is equipped with a kit, containing spare parts as illustrated in figure 39. The kit is located in the spare parts box, under the map board.

TOOLS AND EQUIPMENT STOWAGE ON THE VEHICLE

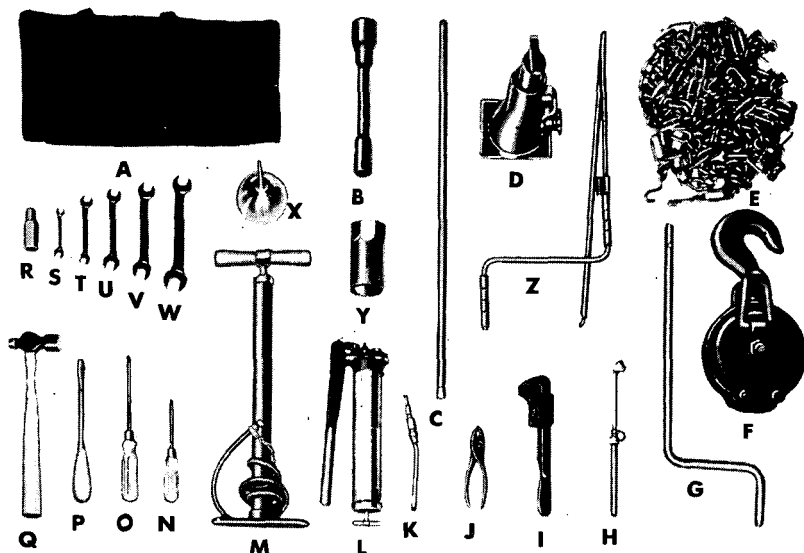

- A**—BAG, TOOL
B—WRENCH, WHEEL SOCKET
C—HANDLE, WHEEL WRENCH
D—JACK
E—CHAINS, TIRE
F—BLOCK, SNATCH
 (WINCH EQUIPPED VEHICLES)
G—CRANK, STARTING
H—GAGE, TIRE PRESSURE
I—WRENCH, ADJUSTABLE
J—PLIERS
K—ADAPTER, GREASE GUN
L—GUN, GREASE
M—PUMP, TIRE
N—SCREWDRIVER, CROSS RECESS, SMALL
O—SCREWDRIVER, CROSS RECESS, LARGE
P—SCREWDRIVER, PLAIN
Q—HAMMER
R—WRENCH, SPARK PLUG
S—WRENCH, OPEN END, $\frac{1}{32}$ IN. AND $\frac{3}{8}$ IN.
T—WRENCH, OPEN END, $\frac{7}{16}$ IN. AND $\frac{1}{2}$ IN.
U—WRENCH, OPEN END, $\frac{9}{16}$ IN. AND $\frac{5}{8}$ IN.
V—WRENCH, OPEN END, $\frac{11}{32}$ IN. AND $\frac{11}{16}$ IN.
W—WRENCH, OPEN END, $\frac{3}{4}$ IN. AND $\frac{7}{8}$ IN.
X—CAN, OIL
Y—WRENCH, WHEEL BEARING ADJUSTING NUT
Z—HANDLE, JACK

RA PD 312546

Figure 40—Vehicle Tools and Equipment

e. **Care of Tools and Equipment.** Tools subjected to water and dirt will rust if not cleaned and wiped dry. After using tools and equipment, clean and dry them thoroughly and store in the spaces provided on vehicles.

d. **Pioneer Equipment.** The following pioneer equipment is on the vehicle:

AX, 41-A-1277
 CONTAINER, 5 gal,
 42-D-1280

MATTOCK, 41-M-720,
 with handle
 SHOVEL, 41-S-3170

3/4-TON 4 x 4 TRUCK (DODGE)

PART TWO—VEHICLE MAINTENANCE INSTRUCTIONS

Section IX

RECORD OF MODIFICATIONS

Paragraph

MWO and major unit replacement record 26

26. MWO AND MAJOR UNIT REPLACEMENT RECORD.

a. Description. Every vehicle is supplied with a copy of AGO Form No. 478 which provides a means of keeping a record of each MWO completed or major unit assembly replaced. This form includes spaces for the vehicle name and U.S.A. Registration Number, instructions for use, and information pertinent to the work accomplished. It is very important that the form be used as directed and that it remain with the vehicle until the vehicle is removed from service.

b. Instructions for Use. Personnel performing modifications or major unit assembly replacement must record clearly on the form a description of the work completed and must initial the form in the columns provided. When each modification is completed, record the date, hours and/or mileage, and MWO number. When major unit assemblies, such as engines, transmissions, transfer cases, are replaced, record the date, hours and/or mileage and nomenclature of the unit assembly. Minor repairs and minor parts and accessory replacements need not be recorded.

c. Early Modifications. Upon receipt by a third or fourth echelon repair facility of a vehicle for modification or repair, maintenance personnel will record the MWO numbers of modifications applied prior to the date of AGO Form No. 478.

Section X

NEW VEHICLE RUN-IN TEST

	Paragraph
Introduction	27
Run-in test procedures	28

27. INTRODUCTION.

a. **General.** When a new or reconditioned vehicle is first received at the using organization, it is necessary for second echelon personnel to determine whether or not the vehicle will operate satisfactorily when placed in service. For this purpose, inspect all accessories, sub-assemblies, assemblies, tools, and equipment, to see that they are in place and correctly adjusted. In addition, they will perform a run-in test of at least 50 miles as directed in AR 850-15, paragraph 25, table III, according to procedures in paragraph 28 below.

b. **Correction of Deficiencies.** Deficiencies disclosed during the course of the run-in test will be treated as follows:

(1) Correct any deficiencies within the scope of the maintenance echelon of the using organization before the vehicle is placed in service.

(2) Refer deficiencies beyond the scope of the maintenance echelon of the using organization to a higher echelon for correction.

(3) Bring deficiencies of serious nature to the attention of the supplying organization.

28. RUN-IN TEST PROCEDURES.

a. **Preliminary Service.**

(1) **FIRE EXTINGUISHER.** See that the portable extinguisher is present and in good condition. Test it momentarily for proper operation, and mount it securely.

(2) **FUEL, OIL, AND WATER.** Fill fuel tank. Check crankcase oil and coolant supply, add oil and coolant as necessary to bring to correct levels. Allow room for expansion in fuel tank and radiator. During freezing weather, test value of antifreeze and add as necessary to protect cooling system against freezing. **CAUTION:** *If there is a tag attached to filler cap or steering wheel concerning engine oil in crankcase, follow instructions on tag before driving the vehicle.*

(3) **FUEL FILTER.** Inspect fuel filter for leaks, damage, and secure mountings and connections. Drain filter sediment bowl. If any appreciable amount of water or dirt is present, remove bowl, and clean bowl and element in dry-cleaning solvent. Also drain accumulated water or dirt from bottom of fuel tank. Drain only until fuel runs clean.

(4) **BATTERY.** Make hydrometer and voltage test of battery, and add clean water to bring electrolyte $\frac{3}{8}$ inch above plates.

(5) **AIR CLEANER AND BREATHER CAP.** Examine carburetor air cleaner, crankcase filler breather cap, and ventilator outlet filter

¾-TON 4 x 4 TRUCK (DODGE)

unit, to see if they are in good condition and secure. Clean elements and reservoirs. Fill oil bath cleaners to proper level with fresh oil. Dip ventilator outlet element in clean oil. Reinstall all units securely. Be sure all gaskets are in good condition and that ducts and air horn connections are tight.

(6) **ACCESSORIES AND BELTS.** See that accessories such as carburetor, generator, regulator, cranking motor, distributor, fan, water pump, and oil filter are securely mounted. Make sure fan and generator drive belt is in good condition, and adjusted to have ½ inch finger pressure deflection.

(7) **ELECTRICAL WIRING.** Examine all accessible wiring and conduits to see if they are in good condition, securely connected, and properly supported.

(8) **TIRES.** See that all tires, including spare, are properly inflated to 40 pounds, cool; that stems are in correct position; all valve caps present and fingertight. Inspect for damage, and remove objects lodged in treads and carcasses.

(9) **WHEEL AND FLANGE NUTS.** See that all wheel mounting and axle flange nuts are present and secure.

(10) **FENDERS AND BUMPER.** Examine fenders and front bumper for looseness and damage.

(11) **TOWING CONNECTIONS.** Inspect tow hooks and pintle hook for looseness or damage. See that pintle hook operates properly and latches securely.

(12) **BODY AND TARPAULINS.** Inspect body for damage and loose mountings. See that all attachments and items of special equipment are in good condition, and examine tarpaulins and curtains where used for damage and loose fastenings. Be sure doors fit, close, and latch properly. Inspect glass for damage. See that any window lift mechanism and all hardware is in good operating condition and secure. Examine seats, safety straps, floorboards and skid strips, and stowage compartments for good condition, correct assembly, and secure mounting.

(13) **WINCH.** Inspect winch for damage, secure mounting, and oil leaks. Test winch clutch mechanism for proper operation. Test drag brake to see if it holds drum for spinning and as cable is unwound; inspect it for wear, damage, and adequate lubrication. Test winch automatic brake by placing vehicle at top of steep incline and attaching cable to another vehicle at bottom. While drawing towed vehicle uphill, release engine clutch; if towed vehicle backs downhill, brake needs adjustment. Start lowering vehicle downhill with winch; throw out engine clutch; if towed vehicle does not stop or drifts more than one or two inches, brake needs adjustment (par. 189). After test, rewind cable evenly and tightly on drum and as winding, clean cable thoroughly and apply a film of engine oil.

(14) **LUBRICATE.** Perform a complete lubrication of the vehicle, covering all intervals, according to the instructions on the Lubrication Guide (par. 24), except gear cases, wheel bearings, and other

NEW VEHICLE RUN-IN TEST

units lubricated in items (1) to (13). Check all gear case oil levels, and add as necessary to bring to correct level. Change only if condition of oil indicates the necessity, or if gear oil is not of proper grade for existing atmospheric temperature. Perform items (15) to (18) during lubrication.

(15) **SPRINGS AND SUSPENSIONS.** Inspect front and rear springs and shocks to see that they are in good condition, correctly assembled, secure, and that bushings and shackle pins are not excessively loose, or damaged.

(16) **STEERING LINKAGE.** See that all steering arms, rods and connections are in good condition and secure; and that gear case is securely mounted and not leaking excessively.

(17) **PROPELLER SHAFTS.** Inspect all shafts and universal joints to see if they are in good condition, correctly assembled, aligned, secure, and not leaking excessively.

(18) **AXLE AND TRANSFER VENTS.** See that axle housing and transfer case vents are present, in good condition, and not clogged.

(19) **CHOKER.** Examine choke to be sure it opens and closes fully in response to operation of choke button.

(20) **ENGINE WARM-UP.** Start engine and note if cranking motor action is satisfactory, and engine has any tendency toward hard starting. Set hand throttle to run engine at fast idle during warm-up. During warm-up, reset choke button so engine will run smoothly, and to prevent overchoking and oil dilution.

(21) **INSTRUMENTS.**

(a) *Oil Pressure Gage.* Immediately after engine starts, observe if oil pressure is satisfactory. (Normal operating pressure, hot, at running speeds is 40 to 50 pounds, at idle speed 15 pounds.) Stop engine if pressure is not indicated in 30 seconds.

(b) *Ammeter.* Ammeter should show slight positive (+) charge. High charge may be indicated until generator restores to battery, current used in starting.

(c) *Temperature Gage.* Engine temperature should rise gradually during warm-up period, to normal range, 160°F to 185°F.

(d) *Fuel Gage.* Fuel gage should register "FULL" if tank has been filled.

(22) **ENGINE CONTROLS.** Observe if engine responds properly to controls and if controls operate without excessive looseness or binding.

(23) **HORN AND WINDSHIELD WIPERS.** See that these items are in good condition and secure. If tactical situation permits, test horn for proper operation and tone. See if wiper arms will operate through their full range and that blade contacts glass evenly and firmly.

(24) **GLASS AND REAR-VIEW MIRROR.** Clean all body glass and rear-view mirror and inspect for looseness and damage. Adjust mirror for correct vision.

(25) **LAMPS (LIGHTS) AND REFLECTORS.** Clean lenses and inspect all units for looseness and damage. If tactical situation permits,

¾-TON 4 x 4 TRUCK (DODGE)

open and close all light switches to see if lamps respond properly.

(26) **LEAKS (GENERAL).** Look under vehicle, and within engine compartment, for indications of fuel, oil, coolant, and brake fluid leaks. Trace any leaks found to source and correct or report them to designated authority.

(27) **TOOLS AND EQUIPMENT.** Check tools shown in figures 39 and 40, to be sure all items are present, and see that they are serviceable and properly mounted or stowed.

b. Run-in Test. Perform the following procedures (1) to (10) inclusive during the road test of the vehicle. On vehicles which have been driven 50 miles or more in the course of delivery from the supplying to the using organization, reduce the length of the road test to the least mileage necessary to make observations listed below. **CAUTION:** *Continuous operation of the vehicle at speeds approaching the maximums indicated on the caution plate should be avoided during the test.*

(1) **DASH INSTRUMENTS AND GAGES.** Do not move vehicle until engine temperature reaches 135°F. Maximum safe operating temperature is 190°F. Observe readings of ammeter, oil, temperature, and fuel gages to be sure they are indicating the proper function of the units to which they apply. Also see that speedometer registers the vehicle speed and that odometer registers accumulating mileage.

(2) **BRAKES: FOOT AND HAND.** Test service brakes to see if they stop vehicle effectively, without side pull, chatter, or squealing, and observe if pedal free travel is $\frac{7}{16}$ inch before meeting resistance and pedal to under side of floor plate clearance is $\frac{1}{2}$ inch. Parking brake should hold vehicle on a reasonable incline, with $\frac{1}{4}$ to $\frac{1}{3}$ lever ratchet travel in reserve. **CAUTION:** *Avoid long application of brakes until shoes become evenly seated to drums.*

(3) **CLUTCH.** Observe if clutch operates smoothly, without grab, chatter, or squeal on engagement, or slippage under load, when fully engaged. See that pedal has $1\frac{1}{8}$ inch free travel before meeting resistance. **CAUTION:** *Do not ride clutch pedal unnecessarily, and do not engage or disengage new clutch severely, until driven and driving disks have become properly worn in.*

(4) **TRANSMISSION AND TRANSFER.** Gearshift mechanism should operate easily and smoothly, and gears should operate without unusual noise, and not slip out of mesh. Test front axle declutching, and power take-off mechanism (on vehicles so equipped) for proper operation.

(5) **STEERING.** Observe steering action for binding or looseness, and note any excessive pull to one side, wander, shimmy, or wheel tramp. See that column, bracket, and wheel are secure.

(6) **ENGINE.** Be on the alert for any abnormal engine operating characteristics or unusual noise, such as lack of pulling power or acceleration, backfiring, misfiring, stalling, overheating, or excessive exhaust smoke. Observe if engine responds properly to all controls.

(7) **UNUSUAL NOISE.** Be on the alert throughout road test for any unusual noise from body and attachments, running gear, suspen-

NEW VEHICLE RUN-IN TEST

sions, or wheels, that might indicate looseness, damage, wear, inadequate lubrication, or underinflated tires.

(8) **HALT VEHICLE AT 10-MILE INTERVALS FOR SERVICES (9) AND (10) BELOW.**

(9) **TEMPERATURES.** Cautiously hand-feel each brake drum and wheel hub for abnormal temperatures. Examine transmission, transfer case, and differential housings, for indications of overheating and excessive lubricant leaks at seals, gaskets, or vents. *NOTE: Transfer case temperatures are normally higher than other gear cases.*

(10) **LEAKS.** With engine running, and fuel, engine oil, and cooling systems under pressure, look within engine compartment and under vehicle for indications of leaks.

c. Upon completion of run-in test, correct or report any deficiencies noted. Report general condition of vehicle to designated individual in authority.

3/4-TON 4 x 4 TRUCK (DODGE)**Section XI****SECOND ECHELON PREVENTIVE MAINTENANCE**

Paragraph

Second echelon preventive maintenance services. 29

29. SECOND ECHELON PREVENTIVE MAINTENANCE SERVICES.

a. Regular scheduled maintenance inspections and services are a preventive maintenance function of the using arms, and are the responsibility of commanders of operating organizations.

(1) **FREQUENCY.** The frequency of the preventive maintenance services outlined herein is considered a minimum requirement for normal operation of vehicles. Under unusual operating conditions, such as extreme temperatures, dusty or sandy terrain, it may be necessary to perform certain maintenance services more frequently.

(2) **FIRST ECHELON PARTICIPATION.** The drivers should accompany their vehicles and assist the mechanics while periodic second echelon preventive maintenance services are performed. Ordinarily, the driver should present the vehicle for a scheduled preventive maintenance service in a reasonably clean condition: that is, it should be dry and not caked with mud or grease to such an extent that inspection and servicing will be seriously hampered. However, the vehicle should not be washed or wiped thoroughly clean, since certain types of defects, such as cracks, leaks, and loose, or shifted parts or assemblies are more evident if the surfaces are slightly soiled or dusty.

(3) If instructions other than those which are contained in the general procedures in step (4) or the specific procedures in step (5) which follow, are required for the correct performance of a preventive maintenance service, or for correction of a deficiency, other sections of this manual pertaining to the item involved, or a designated individual in authority, should be consulted.

(4) **GENERAL PROCEDURES.** These general procedures are basic instructions which are to be followed when performing the services on the items listed in the specific procedures. *NOTE: The second echelon personnel must be thoroughly trained in these procedures so that they will apply them automatically.*

(a) When new or overhauled subassemblies are installed to correct deficiencies, care should be taken to see that they are clean, correctly installed, properly lubricated, and adjusted.

(b) When installing new lubricant retainer seals, a coating of the lubricant should be wiped over the sealing surface of the lip of the seal. When the new seal is a leather seal, it should be soaked in SAE 10 engine oil (warm if practicable) for at least 30 minutes. Then the leather lip should be worked carefully by hand before installing the seal. The lip must not be scratched or marred.

SECOND ECHELON PREVENTIVE MAINTENANCE

(c) The general inspection of each item applies also to any supporting member or connection, and usually includes a check to see whether or not the item is in good condition, correctly assembled, secure, or excessively worn. The mechanic must be thoroughly trained in the following explanations of these terms:

1. The inspection for "good condition" is usually an external visual inspection to determine if the unit is damaged beyond safe or serviceable limits. The term "good condition" is explained further by the following terms: not bent or twisted, not chafed or burned, not broken or cracked, not bare or frayed, not dented or collapsed, not torn or cut.

2. The inspection of a unit to see that it is "correctly assembled" is usually an external visual inspection to see whether or not it is in its normal assembled position in the vehicle.

3. The inspection of a unit to determine if it is "secure" is usually an external visual examination, a wrench, hand-feel or a pry-bar check for looseness. Such an inspection should include any brackets, lock washers, lock nuts, locking wires, or cotter pins used in assembly.

4. "Excessively worn" will be understood to mean worn close to, or beyond, serviceable limits, and likely to result in a failure if not replaced before the next scheduled inspection.

(d) *Special Services*. These are indicated by repeating the item numbers in the columns which show the interval at which the services are to be performed, and show that the parts, or assemblies, are to receive certain mandatory services. For example, an item number in one or both columns opposite a tighten procedure, means that the actual tightening of the object must be performed. The special services include:

1. *Adjust*. Make all necessary adjustments in accordance with the pertinent section of this manual, special bulletins, or other current directives.

2. *Clean*. Clean units of the vehicle with dry-cleaning solvent to remove excess lubricant, dirt, and other foreign material. After the parts are cleaned, rinse them in clean fluid and dry them thoroughly. Take care to keep the parts clean until reassembled and be certain to keep cleaning fluid away from rubber or other material that it would damage. Clean the protective grease coating from new parts since this material is usually not a good lubricant.

3. *Special lubrication*. This applies either to lubrication operations that do not appear on the vehicle Lubrication Guide, or to items that do appear on such guides, but which should be performed in connection with the maintenance operations, if parts have been disassembled for inspection or service.

4. *Serve*. This usually consists of performing special operations, such as replenishing battery water, draining and refilling units with oil, and changing or cleaning the oil and fuel filter or cartridge.

5. *Tighten*. All tightening operations should be performed with sufficient wrench torque (force on the wrench handle) to tighten the unit according to good mechanical practice. Use a torque-indicating

3/4-TON 4 x 4 TRUCK (DODGE)

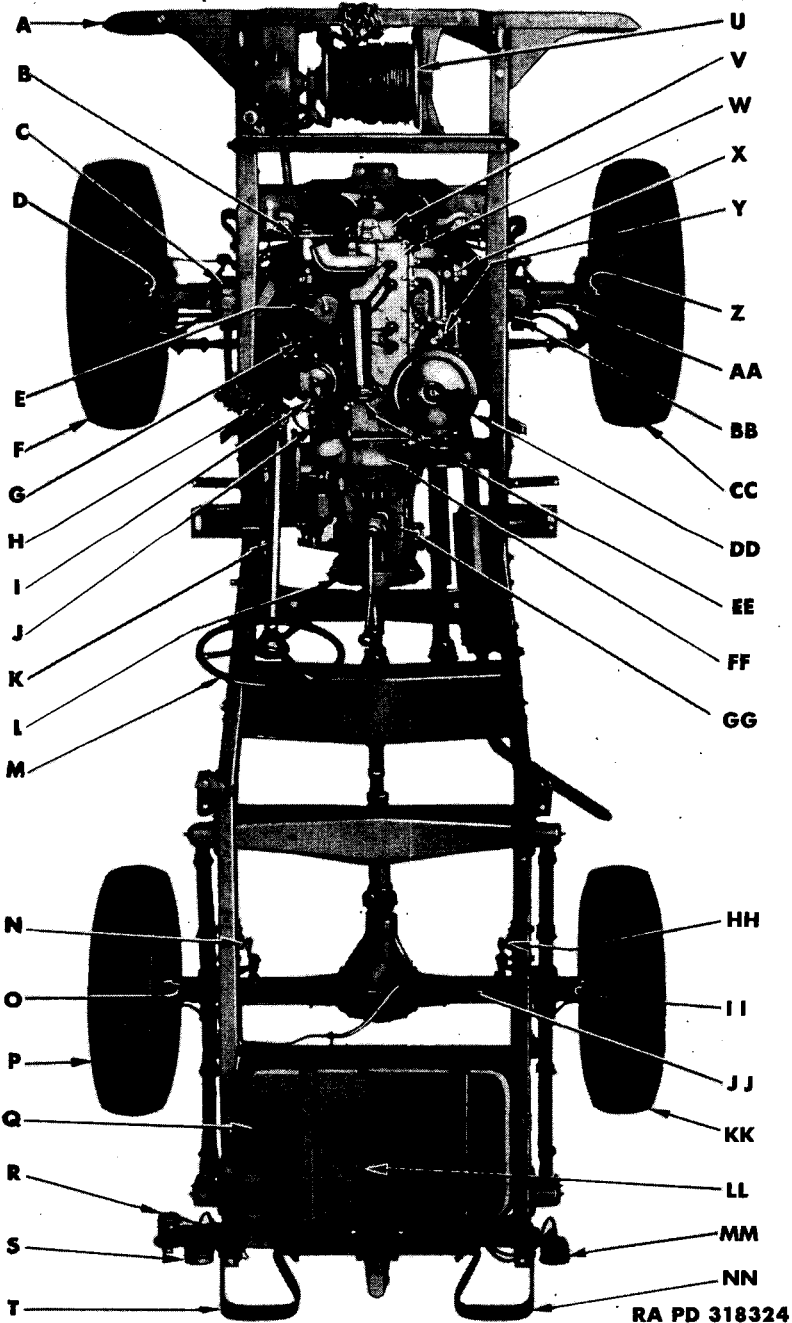

RA PD 318324

Figure 41—Top View of Chassis

SECOND ECHELON PREVENTIVE MAINTENANCE

- | | |
|--|--|
| A —FRONT BUMPER | V —WATER PUMP |
| B —GENERATOR | W —ENGINE |
| C —SHOCK ABSORBER—LEFT FRONT | X —FUEL PUMP |
| D —BRAKE WHEEL CYLINDER—LEFT FRONT | Y —CARBURETOR AND GOVERNOR |
| E —BREATHER PIPE AIR CLEANER | Z —BRAKE WHEEL CYLINDER—RIGHT FRONT |
| F —WHEEL, TIRE, HUB AND BRAKE DRUM—LEFT FRONT | AA —FRONT AXLE HOUSING |
| G —DISTRIBUTOR | BB —SHOCK ABSORBER—RIGHT FRONT |
| H —IGNITION COIL | CC —WHEEL, TIRE, HUB AND BRAKE DRUM—RIGHT FRONT |
| I —OIL FILTER | DD —CARBURETOR AIR CLEANER |
| J —CRANKING MOTOR | EE —HORN |
| K —STEERING GEAR COLUMN JACKET | FF —CLUTCH HOUSING |
| L —HAND BRAKE BAND | GG —TRANSMISSION GEARSHIFT LEVER HOUSING OR COVER |
| M —STEERING WHEEL | HH —SHOCK ABSORBER—RIGHT REAR |
| N —SHOCK ABSORBER—LEFT REAR | II —BRAKE WHEEL CYLINDER—RIGHT REAR |
| O —BRAKE WHEEL CYLINDER—LEFT REAR | JJ —REAR AXLE HOUSING |
| P —WHEEL, TIRE, HUB AND BRAKE DRUM—LEFT REAR | KK —WHEEL, TIRE, HUB AND BRAKE DRUM—RIGHT REAR |
| Q —FUEL TANK | LL —FUEL GAGE (TANK UNIT) |
| R —TRAILER WIRING CONNECTOR | MM —TAIL AND SIGNAL LAMP—RIGHT |
| S —TAIL AND SIGNAL LAMP—LEFT | NN —REAR BUMPER—RIGHT |
| T —REAR BUMPER—LEFT | |
| U —WINCH CABLE AND DRUM | |

RA PD 318324-B

Legend for Figure 41—Top View of Chassis

wrench where specified. Do not overtighten, as this may strip threads or cause distortion. Tightening will always be understood to include the correct installation of lock washers, lock nuts, and cotter pins, provided to secure the tightening.

(e) When conditions make it difficult to perform the complete preventive maintenance procedures at one time, they can sometimes be handled in sections, planning to complete all operations within the week if possible. All available time at halts, and in bivouac areas, must be utilized if necessary to assure that maintenance operations are completed. When limited by the tactical situation, items with special services in the columns, should be given first consideration.

(f) The numbers of the preventive maintenance procedures that follow are identical with those outlined on W.D. AGO Form No. 461, which is the Preventive Maintenance Service Work Sheet for Wheeled and Half-track Vehicles. Certain items on the work sheet, that do not apply to this vehicle, are not included in the procedures in this manual. In general, the numerical sequence of items on the work sheet is followed in the manual procedures, but in some instances there is deviation for conservation of the mechanic's time and effort.

(5) **SPECIFIC PROCEDURES.** The procedures for performing each item in the 1,000-mile (monthly) and 6,000-mile (six-month) maintenance procedures are described in the following chart. Each page

3/4-TON 4 x 4 TRUCK (DODGE)

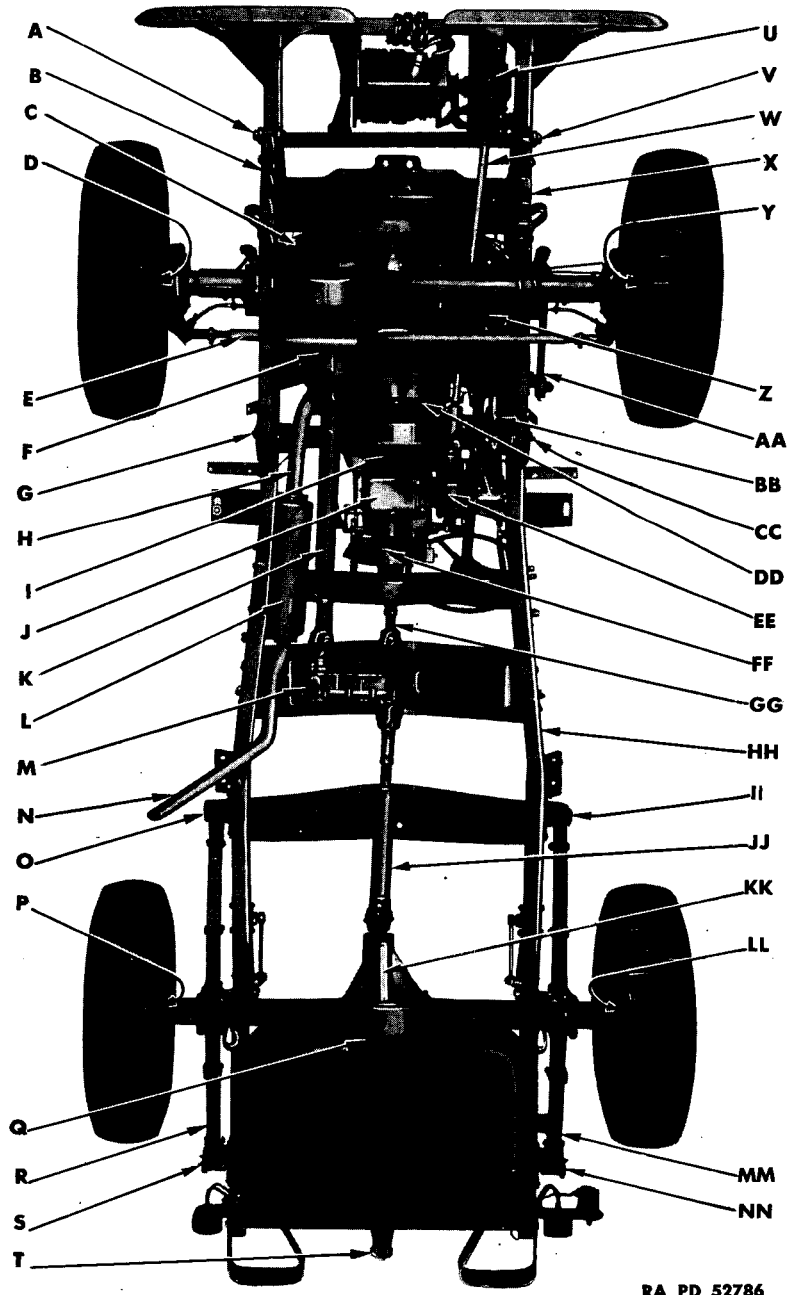

RA PD 52786

Figure 42—Bottom View of Chassis

SECOND ECHELON PREVENTIVE MAINTENANCE

- A**—FRONT SPRING SHACKLE
- B**—FRONT SPRING
- C**—ENGINE DUST PAN—RIGHT
- D**—BRAKE SUPPORT AND ADJUSTING PINS
- E**—STEERING TIE ROD
- F**—FRONT AXLE DIFFERENTIAL AND CARRIER
- G**—FRONT SPRING REAR BOLT
- H**—EXHAUST PIPE
- I**—CLUTCH HOUSING PAN
- J**—TRANSMISSION
- K**—FRONT PROPELLER SHAFT AND UNIVERSAL JOINTS
- L**—MUFFLER
- M**—TRANSFER CASE
- N**—MUFFLER TAIL PIPE
- O**—REAR SPRING FRONT BOLT
- P**—BRAKE SUPPORT AND ADJUSTING PINS
- Q**—HOUSING COVER
- R**—REAR SPRING
- S**—REAR SPRING SHACKLE
- T**—PINTLE HOOK
- U**—WINCH WORM HOUSING
- V**—FRONT SPRING SHACKLE
- W**—WINCH DRIVESHAFT AND UNIVERSAL JOINTS
- X**—FRONT SPRING
- Y**—BRAKE SUPPORT AND ADJUSTING PINS
- Z**—ENGINE DUST PAN—LEFT
- AA**—STEERING DRAG LINK
- BB**—BRAKE MASTER CYLINDER
- CC**—FRONT SPRING REAR BOLT
- DD**—ENGINE OIL PAN
- EE**—POWER TAKE-OFF
- FF**—HAND BRAKE DRUM
- GG**—INTERMEDIATE PROPELLER SHAFT AND UNIVERSAL JOINTS
- HH**—FRAME
- II**—REAR SPRING FRONT BOLT
- JJ**—REAR PROPELLER SHAFT AND UNIVERSAL JOINTS
- KK**—REAR AXLE DIFFERENTIAL AND CARRIER
- LL**—BRAKE SUPPORT AND ADJUSTING PINS
- MM**—REAR SPRING
- NN**—REAR SPRING SHACKLE

RA PD 52786B

Legend for Figure 42—Bottom View of Chassis

of the chart has two columns at its left edge corresponding to the 6,000-mile and the 1,000-mile maintenance respectively. Very often it will be found that a particular procedure does not apply to both scheduled maintenances. In order to determine which procedure to follow, look down the column corresponding to the maintenance due, and wherever an item number appears perform the operations indicated opposite number.

ROAD TEST

MAINTENANCE	
6000 Mile	1000 Mile
1	1
3	3

NOTE: *When the tactical situation does not permit a full road test, perform those items which require little, or no, movement of the vehicle. When a road test is possible, it should be for preferably 5 miles and not over 10 miles.*

Before-operation Service. Perform the Before-operation Service as described in paragraph 19.

Dash Instruments and Gages.

OIL PRESSURE GAGE. Oil pressure should be 30 to 50 pounds above 30 miles per hour; and at least 15 pounds at normal idling speed. Stop engine if oil pressure is too low.

3/4-TON 4 x 4 TRUCK (DODGE)

MAINTENANCE	
6000 Mile	1000 Mile
4	4
5	5
6	6
7	7
8	8

AMMETER. Ammeter should show a positive (+) charge immediately after starting engine. With battery fully charged, ammeter may show zero or only slight charge. Stop engine and investigate discharge (-) readings with lights and accessories turned off.

ENGINE TEMPERATURE GAGE. Reading should increase gradually after starting to normal operating temperature, 160°F to 185°F. Maximum safe temperature is 200°F.

SPEEDOMETER. See that speedometer and odometer are functioning.

FUEL GAGE. Gage should register approximate amount of fuel in tank.

Horns, Mirrors, and Windshield Wipers. If tactical situation permits, test horn for proper operation and tone. See that rear vision mirror and wipers are in good condition and secure. Test operation of wiper motors and see that wiper blades contact glass evenly and operate through their full range.

Brakes. Operate brakes at various speeds during road test.

FOOT BRAKS. Test brakes for effectiveness, pull to one side, unusual noise, or chatter. Pedal should have 1/16 inch free travel before meeting resistance, and should return to off position when released without striking rear engine support.

HAND BRAKE. Stop vehicle on reasonable incline; apply hand brake and observe if it latches and holds vehicle effectively; that lever has 1/4 to 1/3 travel in reserve.

Clutch. Pedal free travel should be 1 1/8 inch before meeting resistance. Clutch should stop transmission entirely when vehicle is standing. Note any unusual noise when pedal is depressed which may indicate unsatisfactory release bearing. With transmission in gear, note any tendency to chatter or grab when clutch is engaged or to slip when fully engaged under load.

Transmission and Transfer Case. Transmission lever should move into each gear range position easily. Test transfer case shift lever to see that front axle engages. Note any noise or vibration that may indicate loose mountings, excessively worn or inadequately lubricated parts.

Steering. With vehicle in motion, observe whether there is any indication of looseness or binding or any tendency to wander, shimmy, or pull to one side.

SECOND ECHELON PREVENTIVE MAINTENANCE

MAINTENANCE	
6000 Mile	1000 Mile
9	9
10	10
13	13
14	14
16	16
17	17
18	18

Engine. Observe engine operating characteristics as follows:

IDLE. Engine should idle smoothly without stalling.

UNUSUAL NOISES. Accelerate and decelerate, and listen for knocks and rattles while the engine is under both light and heavy loads.

ACCELERATION AND POWER. Note if engine has normal pulling power and acceleration or any tendency to stall while shifting. A slight ping during fast acceleration is normal.

GOVERNED SPEED. With the vehicle in low gear, observe the speedometer reading to see if the vehicle reaches, but does not exceed, 9 miles per hour with no load. Engine must not surge at full throttle.

10 10 **Unusual Noises.** Be on alert during road test for any noise that might indicate loose or damaged attachments mounted on vehicle, loose cab or body mountings, floor plates, doors, windshield, or hardware.

13 13 **Temperatures.** Place hand cautiously on all brake drums and wheel hubs to see if they are abnormally hot. Inspect axle housings, transmission, and transfer case, for indications of overheating. *NOTE: Transfer case will run considerably hotter than the other units.*

14 14 **Leaks.** Look in engine compartment, and under vehicle for indications of engine oil, coolant, or fuel leaks.

MAINTENANCE OPERATIONS

Raise Vehicle—Block Safely

16 16 **Gear Oil Level and Leaks.** Check lubricant levels in front and rear axles, transmission, and transfer case. Proper level is from lower edge of filler hole (hot) to 1/2 inch below (cold). Note condition of lubricant. If an oil change is due in any of these units or condition of lubricant indicates an oil change is necessary, drain and refill units. Notice any indications of excessive lubricant leaks at oil seals or gaskets. *NOTE: Slight seepage at seals is not considered as leakage.*

17 17 **Unusual Noises.** Trace and correct any unusual noises noted during road test.

18 18 **Cylinder Heads and Gaskets.** Look for cracks or indications of oil, coolant, or compression leaks around

3/4-TON 4 x 4 TRUCK (DODGE)

MAINTENANCE	
6000 Mile	1000 Mile
	19
19	
22	22
22	
	20
20	
21	
23	23

studs, nuts, and gaskets. **CAUTION:** *Cylinder heads should not be tightened unless there is definite evidence of leaks. If tightening is necessary, use torque-indicating wrench, and tighten head nuts in the proper sequence and to 52.5 to 57.5 foot pounds tension (par. 58).*

Valve Mechanism. Adjust valve stem clearance only if noisy. Intake and exhaust clearance, 0.010 inch "go", 0.012 inch "no go" (hot).

ADJUST. Set valve stem clearances to above specifications. Install covers securely with new gaskets.

Battery. Clean top of battery. Inspect case for cracks and leaks. Inspect cables, terminals, bolts, straps, and hold-downs, for good condition. Test specific gravity and voltage (par. 88) and record on W.D. AGO Form No. 461. Specific gravity readings below 1.225 indicate battery should be recharged or replaced. For extremely hot weather (95°F and above) see paragraph 88. Add distilled or clean water to bring battery solution 1/2 inch above top of plates.

Perform high-rate discharge test according to instructions for "condition" test which accompany test instrument and record voltage on W.D. AGO Form No. 461. Cell variation should not be more than 30 percent. **NOTE:** *Specific gravity must be above 1.225 to make this test.*

Spark Plugs. Without removal, wipe off plugs and examine insulation for damage or indications of compression leaks.

Blow dirt from spark plug depressions in cylinder head and remove all plugs. Look for broken insulators, excessive carbon or oxide deposits, and for burned electrodes. Clean plugs thoroughly. If plug cleaner is not available, install new or reconditioned plugs. **NOTE:** *Do not install plugs until item 21 has been performed.* Set plug gaps to 0.025 inch by bending only grounded electrodes.

Compression Test. Test compression with all spark plugs removed. Compression pressure at cranking speed is normally 98 to 118 pounds. There should not be more than 20 pounds variation between cylinders. Record compression pressures on back of work sheet, Form No. 461.

Crankcase. With engine idling, examine exterior of engine for oil leaks. Stop engine and check to see if oil is at proper level. If an oil change is due, or condition of

SECOND ECHELON PREVENTIVE MAINTENANCE

MAINTENANCE	
6000 Mile	1000 Mile
24	24
25	25
25	
26	26
26	
27	27
27	

oil indicates the necessity, drain crankcase and refill to correct level. **NOTE:** *Do not again start engine until item 24 has been performed.*

Oil Filter and Lines. Inspect filter and external engine oil lines to see if they are in good condition, secure, and not leaking. Remove filter body drain plug and drain off contents. Remove filter cartridge and check condition. If cartridge change is due, or condition indicates the necessity, replace with new cartridge being sure gaskets are in place and tighten cover and drain plug securely.

Radiator (Core, Shell, Mountings, Hose, Cap and Gasket, Antifreeze Record, Overflow Pipe). Inspect all parts of cooling system to see that they are in good condition, secure, and not leaking. Examine condition of coolant to see whether it is contaminated and system should be cleaned. If cleaning is necessary, proceed only according to current directives covering proper procedure and recommended cleaner, neutralizer, and inhibitor materials. Clean all insects, dirt, or grease deposits, from core air passages and inspect for bent cooling fins. **CAUTION:** *Use only a suitably shaped piece of wood or blunt instrument to straighten fins.* If antifreeze is in use, test its protective value and record in space provided on back of work sheet Form No. 461.

TIGHTEN. Tighten all loose radiator mountings, water connections, hose clamps and radio noise suppression bond straps (particularly points where toothed lock washers are used), for bonding.

Water Pump and Fan. Inspect pump to see if it is in good condition, secure, and not leaking. Inspect fan to see if it is in good condition, and that blades and hub are secure.

TIGHTEN. Tighten water pump, fan and mounting nuts.

Generator, Starter, and Switch. Inspect generator, starter, and switch, to see if they are in good condition, securely mounted, and if wiring connections are clean and secure. See that radio noise suppression condenser on cranking motor is securely mounted and connected.

Remove generator and starter inspection covers and examine commutators and brushes for excessive wear. See that brushes are free in holders and connection wires are secure and not chafing.

CLEAN. Blow out commutator end of generator and starter with compressed air. If brushes or commutators

3/4-TON 4 x 4 TRUCK (DODGE)

MAINTENANCE	
6000 Mile	1000 Mile
27	
29	29
31	31
31	
32	32
33	33
33	
34	34

are worn excessively, replace unit.

TIGHTEN. Tighten starter mounting bolts securely.

Drive Belt and Pulleys. Examine fan belt for good condition. Inspect all drive pulleys and hubs to see if they are in good condition and securely mounted.

ADJUST. Adjust fan belt for 1/2 inch finger pressure deflections (par. 82).

31 31 Distributor. Observe if distributor body and external attachment are in good condition and secure. Examine other parts as follows:

CAP, ROTOR, AND POINTS. Remove cap and clean. Look for cracks and carbon streaks in cap and rotor, corrosion of terminals and connections. See that points are well alined and adjusted to 0.020 inch, when wide open.

If inside of distributor is dirty, remove assembly, clean in dry-cleaning solvent, dry thoroughly with compressed air and lubricate according to Lubrication Guide. If breaker points are pitted, burned or worn to an unserviceable degree, replace. When cleaning points use contact point dresser (never use emery) and blow out filings with compressed air.

SHAFT. Test shaft by hand-feel for excessive wear in shaft for bushings.

CENTRIFUGAL ADVANCE. Install rotor on shaft and turn clockwise as far as it will go and note if it will return to its original position when released without hang up or binding.

31 ADJUST. Set breaker point gaps to 0.020 inch, when wide open.

32 32 Coil and Wiring. Inspect coil, ignition wiring including shielding or conduits to see if they are in good condition, clean, securely connected, and properly mounted. Inspect all low voltage wiring in engine compartment in like manner.

33 33 Manifolds and Gaskets. Inspect for looseness, damage, or exhaust leaks at gaskets. Examine for evidence of cracks or sand holes usually indicated by carbon streaks. Make sure spark plugs and distributors to coil wire resistor-suppressors are firmly attached to wires, and not scorched or cracked, and that coil ground strap connections are secure.

33 TIGHTEN. Tighten all manifold assembly and mounting nuts securely.

34 34 Air Cleaner. Inspect carburetor air cleaner to see if it is in good condition, securely mounted and connected,

SECOND ECHELON PREVENTIVE MAINTENANCE

MAINTENANCE	
6000 Mile	1000 Mile
35	35
36	36
37	37
38	38
38	
39	39
40	40
41	41

and not leaking. Remove reservoir and element, wash in dry-cleaning solvent, dry, fill reservoir to proper level with clean engine oil and reassemble. Be sure gaskets are in place and all joints and air horn connections tight.

Breather Cap and Ventilator. Inspect crankcase breather cap and ventilator outlet to see if they are in good condition, secure, and not leaking. Remove oil reservoir and element, or filter type elements, wash clean in dry-cleaning solvent, refill reservoir with fresh engine oil and reassemble securely. If not oil bath type, dip elements in clean engine oil, drain off excess and reinstall securely. If engine is equipped with a positive type ventilator, remove metering valve and tube assembly. Disassemble and clean all parts with dry-cleaning solvent to remove carbon and gum deposits and assemble to engine.

Carburetor and Governor. See if they are in good condition, correctly assembled, and securely installed; that carburetor does not leak; that control linkage, including choke and throttle shaft, is not excessively worn; if choke valve opens fully when the control is in its released position; if throttle valve opens fully when the accelerator is fully depressed; and if the governor is secure and properly sealed.

Fuel Filter and Lines. Examine filter to see if it is in good condition; securely mounted and connected, and not leaking.

CLEAN. Remove sediment bowl and element. Wash clean in dry-cleaning solvent and reassemble securely with gasket in place. **CAUTION:** *If element cannot be cleaned without disassembly by loosening, separating, and washing disk, replace unit. Do not scrape element to clean.*

Fuel Pump (pressure). Inspect pump to see if it is in good condition, securely mounted and not leaking. Remove sediment bowl and screen and wash in dry-cleaning solvent. Be sure gasket is in place and serviceable when bowl is reinstalled.

Attach a test gage to pressure side of fuel pump and after starting engine in item 39 see that pressure is 3 pounds minimum to 5½ pounds maximum at idle speed.

Cranking Motor. Start the engine, observing if general action of cranking motor is satisfactory, has adequate cranking speed; and if the engine starts readily.

Leaks. Recheck all points for leaks, with engine running. Trace any found to source and correct or report them.

Ignition Timing. With engine running and a neon timing light connected, observe if ignition timing is

3/4-TON 4 x 4 TRUCK (DODGE)

MAINTENANCE	
8000 Mile	1000 Mile
41	
42	42
42	42
43	43
43	
47	47

correct. Also note whether automatic controls advance the timing as engine is accelerated gradually.

Adjust ignition timing according to instructions (par. 99).

Engine Idle and Vacuum Test. Inspect as follows:

ADJUST. See paragraph 70. Adjust engine to its normal idle speed and then adjust the idle-mixture until vacuum gage indicates a steady maximum reading.

VACUUM TEST. See paragraph 70. With the engine running at normal idling speed, vacuum gage should read not less than 17 inches at sea level with a reduction of approximately 3½ inches for each 5,000 feet altitude and pointer should be steady. At full throttle, vacuum reading should be at least 16 inches at sea level.

Regulator Unit. Inspect generator regulator to see if it is in good condition, securely mounted, and connected. Be sure radio noise suppression filter is securely mounted and connected.

TEST. Connect a low-voltage-circuit tester and observe if voltage regulator, current regulator, circuit breaker and control generator output properly. Follow instructions in paragraph 36. Replace if test shows faulty operation.

Tires and Rims. Inspect as follows:

VALVE STEMS AND CAPS. Observe if all valve stems and caps are in good condition and in correct position.

CONDITION. Examine all tires for cuts, bruises, breaks, and blisters. Remove embedded glass, nails, and stones. Look for irregular tread wear, watching for any sign of flat spots, cupping, feather edges, and one-sided wear. Remove tires worn thin at center of tread (or other un-serviceable tires) and exchange for new or retreaded tires. Any mechanical deficiencies causing such conditions should be determined and corrected or reported. Wheel positions of tires with irregular wear should be relocated to even up wear (par. 162).

DIRECTION. Directional tires and non-directional tires should not be installed on same vehicle. Directional tires on rear wheels should be mounted so that the "V" of chevron will point down when viewed from the front. Directional tires on all front wheels will ordinarily be mounted so that "V" of chevrons will point up when viewed from front of vehicle.

MATCHING. With tires properly inflated, inspect them to see if they are matched according to over-all circumference and type of tread.

SECOND ECHELON PREVENTIVE MAINTENANCE

MAINTENANCE	
6000 Mile	1000 Mile
47	47
48	
	49
49	

SPARE TIRE CARRIERS. See whether spare tire carriers are in good condition and secure.

RIMS. All rims and side lock rings and flanges should be in good condition and secure.

TIGHTEN. Tighten all wheel side ring, mounting and flange nuts securely.

SERVE. With all tires properly inflated to 40 pounds (cold), check over-all circumference, including spares. Select tires to be mounted on driving axles, so that difference in over-all circumference does not exceed the 3/4-inch limits specified in current directives and bulletins. **NOTE:** *Spares must be matched properly and mounted for use on one of the road wheels at intervals not exceeding 90 days.* A convenient time to do this is during these maintenance services. **CAUTION:** *After performing the tire-matching service do not reinstall until wheel bearing services are completed.*

Rear Brakes. Inspect and service as follows: Remove rear wheels.

NOTE: *On 6,000-mile maintenance several wheel bearings and brake items up to 52 are group services and overlap. Perform in best order for economy of time and orderly reassembly.*

DRUMS AND SUPPORTS. Clean dirt and grease from drums and supports (dust shields) keeping dry-cleaning solvent away from linings. Examine drums and supports to see if they are in good condition, securely mounted, and if drums are excessively worn or scored.

WHEEL CYLINDERS. Inspect cylinders to see if they are in good condition, securely mounted, connected, and if leaking. See if rubber end covers are deteriorated.

TIGHTEN. Tighten front brake support cap screws and all hubs to drum screws securely.

Rear Brake Shoes. Examine linings through inspection holes to determine if satisfactory for another 1,000 miles of operation. If vehicle has been operated in deep water, mud, or loose sand, remove one of the brake drums and examine lining for damage. If damaged, remove all drums and service brakes as necessary.

ADJUST. Adjust shoes if necessary (par. 151). Remove rear wheels, hubs, and drums and inspect linings to see if they are in good condition. Also see if shoes are in good condition. Thickness of lining at most worn point should be enough for at least 1,000 miles of service before rivet heads are likely to contact drums.

CLEAN. Remove all dirt from linings with wire brush, cloth, or compressed air. If there is evidence of grease or brake fluid, reline brakes.

3/4-TON 4 x 4 TRUCK (DODGE)

MAINTENANCE	
6000 Mile	1000 Mile
52	52
	52
52	
52	
52	
	53
53	
	54
54	
54	54
55	55

ADJUST. After subsequent related items to 60 inclusive are completed, adjust shoes (par. 151).

Rear Wheels. Inspect and service as follows:

WHEELS. Inspect wheels to see if they are in good condition and secure.

BEARINGS AND SEALS. Check for looseness of wheel bearing-adjustment. Revolve wheels and listen for evidence of dry or damaged bearings. Inspect around flanges and brake supports for lubricant leaks.

DRIVE FLANGES AND NUTS. Note if they are in good condition and if nuts are tightened securely.

CLEAN. Disassemble rear wheel bearings and oil seals. Clean thoroughly in dry-cleaning solvent and examine bearing cups and cones to see if they are in good condition; if machined surfaces they contact are in good condition and if there is any excessive wear.

LUBRICATION. When all of the related items are performed to the point where wheel bearings are to be reinstalled, lubricate bearings according to Lubrication Guide (par. 24).

ADJUST. After lubricating wheel bearings, reassemble hub-and-drum assemblies into place and adjust wheel bearings correctly according to paragraph 147.

Front Brakes. Inspect front brake hose to see if it is in good condition, correctly assembled, and secure.

Remove front wheels, hubs and drums and inspect and service as follows:

DRUMS AND SUPPORTS. Clean and inspect in same manner as in item 48.

WHEEL CYLINDERS. Inspect in same manner as in item 48.

Front Brake Shoes. Inspect in same manner as in item 49.

ADJUST. Adjust if necessary (par. 151). Inspect shoes, linings, anchors, and springs, in same manner as in item 49 at 6,000-mile service.

CLEAN. Clean in same manner as in item 49.

ADJUST. Adjust in same manner as in item 49 after subsequent related items to 60 inclusive are completed (par. 151).

Steering Knuckles (Joints, Bearings, Seals). Inspect to see if knuckle housings are in good condition. Look particularly for cracks around steering arms. See if outside knuckle felt seals and seal flanges are in good

SECOND ECHELON PREVENTIVE MAINTENANCE

MAINTENANCE		
6000 Mile	1000 Mile	
55		condition and secure. Remove lower lubrication level plug and examine sample of lubricant to see if it appears to be contaminated.
55		CLEAN. Remove constant velocity universal joint assembly. Wash thoroughly in dry-cleaning solvent, and without disassembly of universal joint, inspect parts to see if they are in good condition and not excessively worn. Pay particular attention to universal joint balls and races, axle splines, flanges, and pivot bearings or bushings.
55		LUBRICATION. Pack new lubricant well into constant velocity universal joint until it fills all space between balls and races. Reassemble steering knuckle, taking care to replace any unserviceable lubricant retainer seals, boots, or gaskets.
55		ADJUST. Adjust knuckle bearing to 25 to 27½ foot-pounds. Install shims under upper bearing retainer plate or steering arm to insure correct alinement of parts (par. 143).
56	56	Front Springs. See if they are in good condition, correctly assembled, and secure. Spring leaves should not be shifted out of their correct position; this may be an indication of a sheared center bolt. Note if deflection of both springs is approximately the same. Test hangers and bolts for excessive wear by means of a pry bar.
		TIGHTEN. Tighten all spring U-bolts securely and uniformly.
57	57	Steering. See if all parts of steering mechanism are in good condition, correctly and securely assembled and mounted, if steering gear case is leaking lubricant and if lubricant is at proper level. Pay particular attention to pitman arm to see if it is securely mounted and not bent out of its normal shape. Also observe if steering system is in good adjustment.
57		TIGHTEN. Tighten steering arm shaft nut securely. Loosen steering column bracket and tighten steering gear case assembly mounting bolts. Tighten steering column bracket.
58	58	Front Shock Absorbers and Links. See if bodies are in good condition, secure to frame, and not leaking; if links are secure and not damaged. If rubber bushings are hard or cracked, apply brake fluid to exposed surfaces.
58		SERVE. Fill shock absorber bodies with specified fluid (par. 176).
60	60	Front Wheels. Inspect front wheels, bearings, seals,

3/4-TON 4 x 4 TRUCK (DODGE)

MAINTENANCE	
6000 Mile	1000 Mile
60	
60	
61	61
62	62
62	
63	63
64	64
64	
65	65

drive flanges, and nuts in same manner as in item 52 for similar rear wheel items.

CLEAN. Disassemble, clean, and inspect the front wheel bearings and oil seals in the same manner as described in item 52.

LUBRICATION. Apply in same manner as described in item 52.

ADJUST. Adjust wheel bearings in same manner as described in item 52 (par. 142), and adjust brake shoes as described in item 49 (par. 151).

61 Front Axle. If front axle appears to be out of line, measure distance from front spring eyebolt to center of axle spring pad on each side. Distance should be equal. Inspect axle housing to see if it is in good condition and not leaking. Examine pinion shaft for excessive end play and seal for leaks.

CLEAN. Clean axle housing vent thoroughly.

62 Front Propeller Shaft. See if universal joints are in good condition, correctly and securely assembled and mounted; if the universal joints are properly alined with each other and are not excessively worn; that the slip joint is free, not excessively worn, and well lubricated; and that the seals on slip joint do not leak.
NOTE: *Slight seepage at seals is not considered as leakage.*

62 TIGHTEN. Tighten all universal joint assembly and companion flange bolts securely.

63 Engine (Mountings, Ground Strap, Side Pans). These items should be in good condition and securely mounted and connected. Be sure to examine both front and rear engine mountings; and to see that rubber is not separating from its metal backing. If mounting bolts are loose, tighten them properly, taking care not to overtighten (par. 67). Remove oil or grease from rubber mountings. Apply a film of brake fluid if rubber is hard or cracking.

64 Hand Brake. Examine to see if ratchet, pawl, and linkage are in good condition, secure and not excessively worn; that drum is not scored or oily; and that lining is not oil soaked or worn too thin.

64 ADJUST. Set clearance between brake drum and lining to 0.010 inch to 0.012 inch (par. 157).

65 Clutch Pedal. Check pedal free travel. Should be 1 1/8 inch before meeting resistance. Examine to see if pedal is securely mounted to shaft, if clutch operating linkage is in good condition, secure and not excessively

SECOND ECHELON PREVENTIVE MAINTENANCE

MAINTENANCE		
6000 Mile	1000 Mile	
65		worn at friction joints. See if return spring has proper tension to bring pedal to correct released position, and that stop is set to allow $\frac{1}{2}$ inch between pedal and bottom of floor plate.
		ADJUST. Adjust clutch pedal free travel to $1\frac{1}{8}$ inches (par. 130).
66	66	Brake Pedal. Pedal should not bind on support shaft. Be sure return spring has tension to bring pedal to correct released position. Set pedal-stop screw so that pedal does not strike engine support when released. There should be $\frac{7}{16}$ inch free travel before pedal starts to apply master cylinder push rod (par. 151).
67	67	Brake Master Cylinder. Cylinder should be in good condition and secure. Filler plug vent must be open and boot properly installed. Inspect for fluid leaks. See that stop light switch is securely mounted and connected.
67	67	SERVE. Wipe dirt from around filler plug, remove plug and fill master cylinder reservoir to correct level with specified fluid. Clean out filler plug vent hole. Install plug securely, using new gasket if needed.
71	71	Transmission. Note if transmission case is in good condition, securely mounted, and inspect for lubricant leaks at seals and gaskets. NOTE: <i>Slight seepage at seals is not considered as leakage.</i>
72	72	Transfer Case. See if case is in good condition, securely mounted, that shift control linkage and mechanism is securely connected and not damaged. Look for evidence of lubrication leaks at seals and gaskets. NOTE: <i>Slight seepage at seals is not considered as leakage.</i> Clean vent passage if clogged.
72		TIGHTEN. Draw up all external assembly and mounting nuts securely.
73	73	Rear Propeller Shaft. Inspect in same manner as in item 62.
		TIGHTEN. Draw up all universal joint and companion flange bolts securely.
75	75	Rear Axle. Inspect in the same manner as in item 61 for front axle.
		CLEAN. Clean axle housing vent thoroughly.
77	77	Rear Springs. Inspect and tighten in same manner as in item 56.
78	78	Rear Shock Absorbers and Links. Inspect in same manner as in item 58.
78		SERVE. Service and make operating check in same manner as in item 58.
79	79	Cab and Body Mountings. Examine all mountings to see if they are in good condition and properly compressed (par. 185).

3/4-TON 4 x 4 TRUCK (DODGE)

MAINTENANCE		
6000 Mile	1800 Mile	
		TIGHTEN. Tighten cab and body mounting bolts securely (par. 185), taking care to loosen the steering column clamp before alining or tightening cab. Be sure to tighten steering column clamp.
80	80	Frame. Inspect frame, brackets, side rails, and cross members to see if they are in good condition, secure and correctly alined. If the frame appears to be out of line, report to higher echelon.
81	81	Wiring, Conduit, and Grommets. Observe these items underneath the vehicle, to see if they are in good condition, properly supported, connected, and secure.
82	82	Fuel Tank, Fittings, and Lines. Inspect fuel tank to see if it is in good condition and securely mounted. Examine cap for defective gasket. See that filler neck is in good condition and that cap fits securely.
82		Remove fuel tank drain plug and drain off accumulated water and dirt in bottom of tank. Drain only until fuel runs clear. Use necessary precautions against fire.
83	83	Brake Lines. Examine all lines, fittings, and brake hose under vehicle to see if they are in good condition, securely connected, so that they do not leak, and supported so lines or hose will not chafe against other vehicle parts.
84	84	Exhaust Pipes and Muffler. Examine exhaust pipe to see if it is securely attached to exhaust manifold, that gasket or packing does not show evidence of leakage, and that the other end is clamped securely to muffler. Inspect muffler to see if it is in good condition and securely mounted. Check tail pipe to see if it is securely clamped to muffler, properly supported, and unobstructed at its outer end.
85	85	Vehicle Lubrication. Lubricate all points of vehicle in accordance with Lubrication Guide (par. 24) and current lubrication bulletins or directives, using only clean lubricants and omitting items that have had lubrication during this service. Replace damaged or missing fittings, vents, or plugs.
LOWER VEHICLE TO GROUND		
86	86	Toe-in and Turning Stops. With front wheels in straightahead position, check toe-in which should be 0 to $\frac{1}{8}$ inch, $\frac{1}{16}$ preferred (par. 141). Turn wheels fully in both directions and see if turn is limited by stops. In this position note if tires clear all parts of vehicle. If tires touch any part of the vehicle, report for check of turning angle by higher echelon.
87	87	Winch. On winch-equipped vehicles (Weapons Carrier and Command), inspect winch, drive, and controls to

SECOND ECHELON PREVENTIVE MAINTENANCE

MAINTENANCE	
5000 Mile	1000 Mile
87	
91	91
91	
92	92
93	93
94	94
95	95
96	96

see if they are in good condition, correctly assembled, and secure. See if clutch moves freely and locks securely. Test safety brake. Pull the vehicle up a steep bank with the winch. Release engine clutch; if vehicle does not stop or drifts more than one or two inches, brake needs adjusting. Test drag brake to see that it holds drum from spinning when cable is unwound. Inspect winch drive shaft in same manner as in item 62. Note if cable is wound evenly and tightly, and properly secured. Add or drain worm gear housing oil as necessary to bring to correct level. If an oil change is due, or condition of lubricant warrants, drain gear case and refill to proper level.

CLEAN AND SERVE. Unwind cable and inspect for excessive wear, damage, and rust. Clean entire length of cable. As cable is rewound evenly, apply a film of engine oil. Fasten cable securely to front tow hooks.

Lamps (Lights). Operate all switches and note if lamps respond. See if foot switch controls head lamp beams properly and if beams are aimed so as not to blind oncoming traffic. Examine all lights to see if they are in good condition and securely mounted and whether lenses are dirty or reflectors discolored.

ADJUST. Adjust head lamp beams.

Safety Reflectors. See if they are all present, in good condition, clean, and secure.

Front Bumper Tow Hooks, Brush Guards, and Grille, See if they are in good condition, secure, and that radiator grille is not obstructed.

Hood and Fasteners. Inspect engine hood and fasteners to see if they are in good condition and that fasteners operate properly and hold hood securely. Also be sure all radio suppression units not covered in the foregoing procedures are in good condition and securely mounted and connected (figs. 112 to 120).

Front Fenders and Running Boards. Examine fenders and running boards to see if they are in good condition and securely mounted.

Cab or Passenger Body. Inspect doors, hardware, windshield and glass, top and frame, side curtains, seats, safety straps and grab rails, floor boards, ventilators, map compartment and tables, to see if they are in good condition and secure; that the hardware and ventilators operate properly and are adequately lubricated; and if the doors engage their bumpers and strikers and latch properly in the closed position. See that the doors are properly alined with their openings. **NOTE:**

3/4-TON 4 x 4 TRUCK (DODGE)

MAINTENANCE	
6000 Mile	1000 Mile
97	97
97	
98	98
99	99
100	100
101	101
103	103
104	104
131	131

Glass need not be replaced as unserviceable even though cracked or if laminated layers have separated, unless condition constitutes a safety hazard or obstructs vision of driver or crew.

Heater, Fan, and Defroster. On vehicles equipped with any or all of these items, inspect them to see if they are in good condition, securely mounted and connected, and if they function satisfactorily. Examine heaters for leaks. See that vent fan (Ambulance) opening is not obstructed.

SPECIAL LUBRICATION. Apply a few drops of light oil to fan motor bearings.

Circuit Breaker. Observe if in good condition, clean, dry, and securely connected and mounted.

Rear Fenders. See that they are in good condition and securely mounted.

Body (Panels, Rear Doors, Tailgate and Chains, Floor, Skid Strips, Bows, Top Tarpaulins, Curtains, Troop Seats, Stowage Compartments, Stretchers). Inspect all applicable items on each type of vehicle, to see that they are in good condition, correctly and securely assembled and mounted, and adequately lubricated. Any hinges and latches must be free but not excessively worn.

Pintle Hook. Examine pintle to see if it is in good condition and securely mounted to frame. Test pintle and latch to see if they operate properly; are adequately lubricated, and if lock pin is present and securely attached by chain. Pay particular attention for broken spring or worn draw bar.

Paint and Markings. Examine paint of entire vehicle to see if it is in good condition, paying particular attention to any bright spots in finish or camouflage pattern, that might cause glare or reflection. Inspect vehicle markings and identification, unless covered for tactical reasons, for legibility. Include identification plates and their mountings if furnished.

Radio Bonding (Suppressors, Filters, Condensers, and Shielding). See that all radio suppression units not covered in the foregoing procedures are in good condition and securely mounted and connected (figs. 112 to 120).

TOOLS AND EQUIPMENT

Tools (Vehicle and Pioneer). Inspect standard vehicle and pioneer tools to see if they are all present in good condition, clean, and properly stowed or securely

SECOND ECHELON PREVENTIVE MAINTENANCE

MAINTENANCE	
6000 Mile	1000 Mile
132	132
133	133
134	134
135	135
136	136
137	137
139	139
141	141
142	142

mounted (pars. 25 and 26). Also examine tools which have cutting edges to see that they are sharp. Any tools mounted on outside of vehicle which have bright or polished surfaces, should be painted or otherwise treated to prevent rust, glare, or reflection.

Fire Extinguisher. See if it is in good condition, securely mounted, and fully charged. The charge may be determined on gas-type extinguishers by weighing with a scale and on liquid-type by shaking. Also be sure nozzles are free from corrosion.

Decontaminator. See if it is in good condition, securely mounted and fully charged. Make the latter check by removing filler plug. **NOTE:** *This solution must be replaced every three months, as it deteriorates.*

First Aid Kit (if specified). See if it is in good condition, and that all of its items are present and properly packed. Report any deficiencies immediately.

Publications and Form No. 26. The vehicle and equipment manuals, Lubrication Guide, and Standard Form No. 26 (Accident Report Form) should be present, legible, and properly stowed.

Traction Devices (Chains). Examine tire chains to be sure they are in good condition, clean (if not in use), not excessively worn, protected against rust, and properly mounted or stowed.

Tow (Chains, Cables, Rope, Snatch Blocks). See if the provided towing devices are in good condition, clean, and properly stowed. Tow chains or cables should be properly protected against rust when not in use. If snatch blocks are furnished, check to see that they operate freely.

Fuel and Water Cans and Brackets. Observe if they are in good condition, secure; if the caps fit tightly and are secured to the can with a chain; and if cans are leaking.

Modifications (MWO's Completed). Inspect vehicle to determine that all MWO's have been completed and entered on W.D., A.G.O. Form No. 478. Enter any modifications on Major Unit Assembly Replacements made during this service.

Final Road Test. Make a final road test, rechecking items 2 to 15 inclusive, and also be sure to recheck the transmission, transfer case, and all driving axles to see that the lubricant is at the correct level and not leaking. Confine this road test to the minimum distance necessary to make satisfactory observations. **NOTE:** *Correct or report all deficiencies found during final road test.*

3/4-TON 4 x 4 TRUCK (DODGE)

Section XII

ORGANIZATION TOOLS AND EQUIPMENT

	Paragraph
Standard tools and equipment	30
Special tools	31

30. STANDARD TOOLS AND EQUIPMENT.

a. All standard tools and equipment available to second echelon are listed in SNL N-19. These tools and equipment have been utilized in describing maintenance operations on the materiel covered by this manual.

31. SPECIAL TOOLS.

Tool	Federal Stock Number
DRIFT, front axle shaft, inner oil seal, and bushing, installing	41-D-1535-25
DRIFT, front wheel, inner bearing oil seal, installing	41-D-1535-50
FIXTURE, engine lifting	
PULLER, rear spring front hanger bolt	41-P-2951-70
WRENCH, governor adjusting	41-W-3734

Section XIII

TROUBLE SHOOTING

	Paragraph
Introduction	32
Engine	33
Fuel system	34
Exhaust system	35
Cooling system	36
Starting system	37
Ignition system	38
Battery and generating system	39
Lighting system	40
Instruments, gages, horn, heater, and roof ventilator	41
Radio interference suppression	42
Clutch	43
Transmission	44
Transfer case	45
Propeller shafts	46
Front and rear axles	47
Foot brakes	48
Hand brake	49
Wheels and tires	50
Steering	51
Springs and shock absorbers	52
Winch	53

32. INTRODUCTION.

a. This section contains trouble shooting information and tests which can be made to help determine the causes of some of the troubles that may develop in vehicles used under average climatic conditions (above 32°F). Each symptom of trouble given under the individual unit or system is followed by a list of possible causes of the trouble. The tests necessary to determine which one of the possible causes is responsible for the trouble are explained after each possible cause.

33. ENGINE.

a. Engine Will Not Turn.

- (1) **STARTER INOPERATIVE.** See paragraph 37.
- (2) **INCORRECT OIL VISCOSITY.** Drain and refill with proper grade of oil (par. 24).
- (3) **SEIZURE.** Attempt to turn engine with hand crank. If engine will not turn, seizure is indicated; notify higher authority.

b. Engine Turns but Will Not Start.

- (1) **COMBUSTION CHAMBERS FLOODED WITH FUEL.** If the choke

3/4-TON 4 x 4 TRUCK (DODGE)

has been used excessively when cranking engine, fuel may flood the combustion chambers and cause hard starting. Push choke button all the way in, pull throttle button all the way out and crank engine to clear out excessive fuel in cylinders. If flooding continues and engine will not start, check fuel system (par. 34).

(2) **FUEL DOES NOT REACH CARBURETOR** (fig. 43). Disconnect fuel tube at carburetor and operate hand priming lever on fuel pump. This should cause fuel to flow from the open tube. (If the lever operates freely without actuating the diaphragm, turn the crankshaft one revolution by hand as fuel pump rocker arm may be on the high point of cam on camshaft.) If free flow of fuel is not evident, fuel is not reaching carburetor. See paragraph 34.

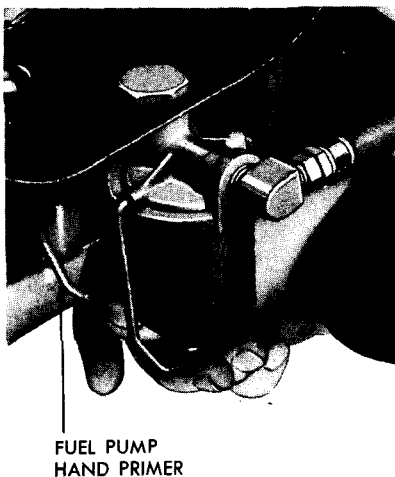

RA PD 52737

Figure 43—Fuel Delivery Test

(3) **IMPROPER IGNITION.** Remove wire from spark plug, hold end of wire about $\frac{1}{4}$ inch from cylinder head and crank engine. If spark does not jump $\frac{1}{4}$ -inch gap, ignition is inadequate (par. 38).

(4) **SLOW CRANKING SPEED.** See paragraph 37.

c. Engine Misfires at High Speed.

(1) **IMPROPER IGNITION.** Inspect distributor breaker points for evidence of burning and measure gap; clean and adjust or replace points. Test breaker arm spring tension and adjust with spring scale (par. 101). Inspect for loose wiring connections in distributor and between coil, distributor, and spark plugs. With distributor rotor

TROUBLE SHOOTING

removed, check for play in distributor drive shaft bushings; if excessive, replace distributor. Clean and inspect spark plugs for wide gaps; inspect for broken porcelains (par. 100). Test ignition coil and condenser (par. 35).

(2) **VALVES STICKING; VALVE SPRINGS WEAK OR BROKEN.** If ignition system is functioning properly (step (1) above) and engine still misfires, notify higher authority.

d. Engine Misfires on Acceleration.

(1) **IMPROPER IGNITION.** Clean and inspect spark plugs for wide gaps; inspect for damaged porcelains (par. 100). Test ignition coil (par. 35). Inspect for loose wiring connections in distributor and

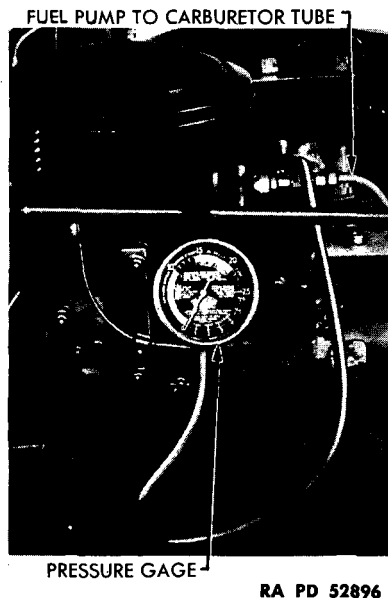

RA PD 52896

Figure 44—Fuel Pump Pressure Test

between coil, distributor, and spark plugs. Inspect distributor breaker points and measure gap (par. 101).

(2) **INSUFFICIENT FUEL DELIVERY.** Clean fuel filter (par. 74). Test fuel pump (par. 34 a (3)). If engine continues to misfire on acceleration, carburetor may be at fault; notify higher authority.

e. Engine Does Not Idle Properly.

(1) **CARBURETOR IMPROPERLY ADJUSTED.** Adjust throttle stop screw and idle adjustment screw with vacuum gage (par. 70).

(2) **AIR LEAKING INTO INTAKE MANIFOLD.** Apply a small amount of oil at carburetor and intake manifold flanges; if oil is sucked in, air is leaking into manifold. Tighten flange nuts or replace gaskets.

3/4-TON 4 x 4 TRUCK (DODGE)

Remove windshield wiper tube and hold finger over manifold connection; if idling improves, air is leaking through windshield wiper connections or tube is broken.

(3) **IMPROPER IGNITION.** Check ignition timing (par. 99). Clean and space spark plugs; inspect for broken porcelains (par. 100).

(4) **INTAKE MANIFOLD OVERHEATED.** Check setting of heat control valve (par. 56).

(5) **COMPRESSION LOW.** Test (par. 55). If low, notify higher authority.

f. Engine Does Not Develop Full Power.

(1) **IMPROPER FUEL MIXTURE.** Inspect air cleaner for restriction of air due to accumulation of dirt in oil reservoir (par. 69). Clean fuel filter (par. 74).

(2) **LOW FUEL PUMP PRESSURE.** See paragraph 34 a (3).

(3) **INTAKE MANIFOLD OVERHEATED.** Check setting of heat control valve (par. 56).

(4) **IGNITION TIMING LATE.** Check with timing light and adjust (par. 99).

(5) **RESTRICTED EXHAUST.** Inspect tail pipe for damage; muffler for clogging and repair or replace (pars. 77, 78, and 79).

(6) **COMPRESSION LOW.** Test (par. 55). If low, notify higher authority.

(7) **VALVES STICKING; VALVE SPRINGS BROKEN.** If causes listed in steps (1) through (5) above are not evident, notify higher authority.

g. Spark Knock or Ping. (A sharp metallic knock occurring on acceleration or when operating under heavy load.)

(1) **IGNITION TIMING TOO EARLY FOR GRADE OF FUEL USED.** Check with timing light and adjust (par. 99).

(2) **CARBON ACCUMULATON IN COMBUSTION CHAMBERS.** Remove cylinder head and clean carbon (par. 58).

(3) **ENGINE OVERHEATING.** See paragraph 36.

(4) **DISTRIBUTOR AUTOMATIC ADVANCE FUNCTIONING IMPROPERLY.** If the causes listed in steps (1) through (3) above are not evident, notify higher authority.

h. Valve Noise.

(1) **VALVE TAPPETS IMPROPERLY ADJUSTED.** Check adjustment (par. 57).

(2) **VALVE SPRING COCKED OR BROKEN.** Aline or replace (par. 57).

(3) **VALVE STEMS OR TAPPETS WORN.** Notify higher authority.

i. Piston Slap. Piston slap is a clear metallic knock when engine is under load at low speed but may not be heard at higher speed or at idling speed. Noise noticeable when engine is cold; will diminish as engine temperature increases.

j. Piston Noise Due to Scored or Worn Pistons or Cylinders. Scored or worn cylinders will cause a noise similar to piston slap after engine has reached operating temperature and vehicle is acceler-

TROUBLE SHOOTING

ated under load. The noise can be heard through the oil breather pipe after removing breather pipe air cleaner.

k. Piston Pin Noise. Piston pin noise is a metallic knock, usually occurring when idling with engine hot. The noise will come and go as the piston pin turns or shifts in piston. Notify higher authority.

l. Bearing Noise.

(1) **LOOSE BEARING.** A loose bearing is usually heard when accelerating at about $\frac{2}{3}$ maximum engine speed. The noise is usually heard momentarily in a series of rapid, distinct knocks. It is difficult to distinguish by sound between main and connecting rod bearing noise. Notify higher authority.

(2) **BURNED-OUT CONNECTING ROD BEARING.** A burned-out connecting rod bearing will be heard as a sharp, distinct knock at most engine speeds, especially noticeable on quick acceleration. The bearing responsible for the knock can usually be determined by shorting the ignition at the spark plugs. Notify higher authority.

(3) **BURNED-OUT MAIN BEARING.** A burned-out main bearing will cause a knock at moderate speeds, especially under acceleration. If the front or intermediate main bearing is responsible, the noise usually can be shorted out; if in the rear main bearing, the knock will have a duller sound, due to the additional area of that bearing. Notify higher authority.

m. Other Engine Noises. Other noises that are frequently confused with bearing or piston noise are listed below.

(1) **FAN BELT PARTIALLY BROKEN OR GLAZED.** A partially broken fan belt will cause a rhythmic metallic noise. A glazed fan belt will cause an intermittent squeal. Replace belt (par. 82).

(2) **SPARK PLUG LOOSE IN CYLINDER HEAD.** A loose spark plug will cause a sharp metallic knock at piston speed frequently confused with other internal engine troubles.

(3) **FLYWHEEL RUBBING CLUTCH HOUSING PAN.** If the clutch housing pan is damaged or bent, the flywheel may rub against the pan causing a scraping sound. The sound may be intermittent when driving over rough terrain.

n. Low or No Oil Pressure.

(1) **ENGINE OIL LEVEL BELOW OIL PUMP STRAINER.** Fill crankcase with oil to proper level (par. 24).

(2) **OIL LEAKAGE.** Inspect for leakage at oil tubes and connections at filter, gage, and cylinder block. Tighten connections or replace tube. If external leakage is not apparent, remove oil pan and tighten oil pump suction and outlet pipe connections.

(3) **OIL PRESSURE RELIEF VALVE PLUNGER NOT SEATING.** Remove and clean (par. 61).

(4) **OIL PUMP GEARS WORN OR DRIVE SHAFT BROKEN; EXCESSIVE CLEARANCE IN ENGINE BEARINGS.** If causes listed in subparagraphs (1) through (3) above are not evident, notify higher authority.

3/4-TON 4 x 4 TRUCK (DODGE)**o. Excessive Oil Consumption.**

(1) **OIL SUPPLY ABOVE RECOMMENDED LEVEL.** Keep oil level at "running level" on oil level indicator (par. 24).

(2) **EXTERNAL OIL LEAKAGE.** Inspect for leakage at external oil tubes and connections, chain case cover and oil pan. Tighten connections and attaching cap screws.

(3) **EXCESSIVE CLEARANCE IN ENGINE BEARINGS, PISTONS AND CYLINDER WALLS; LEAKAGE DUE TO WORN OIL SEALS.** If causes listed in steps (1) and (2) above are not evident, notify higher authority.

34. FUEL SYSTEM.**a. Fuel in Tank Does Not Reach Carburetor.**

(1) **PRESSURE FUEL CAP NOT FUNCTIONING.** Replace cap.

(2) **FUEL FILTER CLOGGED WITH DIRT.** Clean filter (par. 74).

(3) **FUEL PUMP INOPERATIVE** (fig. 44). Connect low pressure gage between the fuel tube and the carburetor and start the engine. If 3 to 5½ pounds pressure is shown on the gage, the fuel pump is operating satisfactorily. If the pressure shown by the gage is less than 3 pounds, inspect the fuel tubes and filter between pump and tank for leaks or obstruction. If fuel tubes and filter are clear and tight, replace fuel pump (par. 73).

b. Fuel Does Not Enter Cylinders.

(1) **CHOKE DOES NOT CLOSE.** Remove air cleaner. Pull out choke button and note whether choke closes. If not, connect or adjust linkage (par. 70).

(2) **CARBURETOR FUEL PASSAGES CLOGGED OR FLOAT VALVE STUCK.** If fuel reaches carburetor (subpar. a above) and choke closes properly (step (1) above), replace the carburetor or notify higher authority.

c. Fuel Flooding Cylinders.

(1) **FUEL TANK CAP VENT CLOGGED.** Replace cap.

(2) **CHOKE DOES NOT OPEN FULLY.** Remove air cleaner. Push choke button in as far as possible and note whether choke opens. If not, connect or adjust linkage (par. 70).

(3) **CARBURETOR FLOAT VALVE NOT SEATING.** If causes listed under steps (1) and (2) above are not evident, replace the carburetor or notify higher authority.

d. Excessive Fuel Consumption.

(1) **AIR CLEANER RESTRICTED.** Service (par. 69).

(2) **IGNITION TIMING LATE.** Test with timing light (par. 99).

(3) **CHOKE DOES NOT OPEN FULLY.** See subparagraph c (1) above.

(4) **CARBURETOR IMPROPERLY ADJUSTED.** Adjust (par. 70).

(5) **BRAKES DRAGGING.** Check brake adjustment (par. 150).

TROUBLE SHOOTING

(6) **LUBRICANT TOO HEAVY IN TRANSMISSION, FRONT AND REAR AXLES.** Use proper grade (par. 24).

(7) **LOW ENGINE OPERATING TEMPERATURE.** See paragraph 14. Inspect cooling system thermostat (par. 84).

(8) **FUEL PUMP PRESSURE TOO HIGH.** Test pump (par. 34 a (3)).

(9) **CARBURETOR FLOAT LEVEL TOO HIGH; LOW ENGINE COMPRESSION.** If the causes listed in steps (1) through (8) above are not evident, notify higher authority.

e. Governor Not Functioning Properly.

(1) **MAXIMUM ENGINE SPEED INCORRECT.** Adjust governor (par. 70 b).

(2) **ENGINE SURGES AT MAXIMUM SPEED.** Adjust governor (par. 70 b).

(3) **GOVERNOR LAGS IN CONTROLLING MAXIMUM SPEED.** Adjust governor (par. 70 b).

35. EXHAUST SYSTEM.

a. Exhaust Fumes Entering Body, or Noisy Exhaust.

(1) **TAIL PIPE LOOSE OR OUT OF MUFFLER.** Tighten or replace (par. 77).

(2) **MUFFLER DAMAGED.** Replace (par. 78).

(3) **MANIFOLD GASKETS LEAKING.** Replace (par. 59).

b. Exhaust System Restricted. Restricted exhaust is indicated by continuous blow or "hiss" from the tail pipe rather than normal intermittent exhaust noise.

(1) **TAIL PIPE KINKED OR PLUGGED WITH DIRT.** Repair or replace pipe (par. 77).

(2) **MUFFLER CLOGGED.** Replace muffler (par. 78).

36. COOLING SYSTEM.

a. Overheating.

(1) **INSUFFICIENT COOLING SOLUTION.** Replenish solution.

(2) **FAN BELT LOOSE OR BROKEN.** Adjust or replace belt.

(3) **HOSE CONNECTIONS COLLAPSED OR OBSTRUCTED.** Replace hose.

(4) **DIRT OR OTHER FOREIGN MATTER LODGED BETWEEN RADIATOR FINS.** Blow out with compressed air or flush from engine side with water from hose.

(5) **THERMOSTAT DAMAGED, BLOCKING CIRCULATION.** Replace thermostat (par. 84).

(6) **WATER PUMP INOPERATIVE OR CIRCULATION OBSTRUCTED IN CYLINDER BLOCK OR RADIATOR CORE.** If causes listed under steps (1) through (5) above are not evident, notify higher authority.

3/4-TON 4 x 4 TRUCK (DODGE)**b. Engine Runs too Cold.**

- (1) **THERMOSTAT DOES NOT CLOSE.** Replace thermostat (par. 84).
- (2) **THERMOSTAT OPENS AT TOO LOW TEMPERATURE.** Test thermostat (par. 84).
- (3) **THERMOSTAT GASKET LEFT OUT.** Install gasket (par. 84).
- (4) **LOW ATMOSPHERIC TEMPERATURES.** Use partial cover over radiator (par. 14).

c. Loss of Coolant.

- (1) **HOSE CONNECTION LEAKS.** Tighten clamps or replace hose.
- (2) **DRAIN COCKS LEAK.** Tighten or replace.
- (3) **CYLINDER HEAD GASKET LEAKS.** Replace gasket (par. 58).
- (4) **RADIATOR CAP INOPERATIVE.** Replace cap.
- (5) **WATER PUMP OR RADIATOR CORE LEAKS.** Replace pump (par. 85) or radiator (par. 86).

37. STARTING SYSTEM.**a. Cranking Motor Will Not Crank Engine.**

- (1) **BATTERY DISCHARGED.** Test (par. 88).
- (2) **LOOSE OR CORRODED CONNECTIONS.** Clean and tighten battery cable connections at battery and ground (engine or chassis). Examine cables for damaged terminal connections.
- (3) **ENGINE SEIZURE.** See paragraph 33 a (3).
- (4) **SWITCH OR CRANKING MOTOR INOPERATIVE.** Disconnect battery positive cable. Disconnect cable at cranking motor switch. Remove switch and hold battery cable tightly against cranking motor terminal post. Then touch the other end of the battery cable to battery post. If cranking motor runs, replace switch; if cranking motor does not run, replace cranking motor.

b. Slow Cranking Speed.

- (1) **ENGINE OIL TOO HEAVY.** In cold weather heavy oil will retard cranking speed and cause voltage drop, especially when engine is cold. Use correct grade of oil (par. 24).
- (2) **LOOSE OR CORRODED CONNECTIONS.** Clean and tighten battery cable connections at battery and ground (engine or chassis). Examine cables for damaged terminal connections.
- (3) **CRANKING MOTOR SWITCH CONTACTS BURNED OR DIRTY.** Disconnect battery cable; remove switch and examine contacts. If burned or dirty, replace switch or clean contacts.
- (4) **INTERNAL FRICTION OR VOLTAGE DROP IN CRANKING MOTOR.** If the causes listed in steps (1) through (3) above are not evident, replace cranking motor or notify higher authority.

c. Cranking Motor Operates and Engages Flywheel but Will Not Turn Engine.

- (1) **SEIZURE.** See paragraph 33 a (3).
- (2) **BATTERY RUN DOWN.** Test (par. 88).

TROUBLE SHOOTING

(3) **CRANKING MOTOR CLUTCH OR SPRING BROKEN OR STUCK.** If the causes listed in steps (1) and (2) above are not evident, replace cranking motor or notify higher authority.

38. IGNITION SYSTEM.

a. Improper Ignition.

(1) **MOISTURE ON IGNITION UNITS.** Wipe distributor cap terminals, cables, spark plugs, and coil thoroughly dry with cloth or cloth saturated with carbon tetrachloride.

(2) **DISTRIBUTOR FAULTY.** Remove distributor cap and rotor; inspect for cracks or carbon runners. Clean contact points and adjust or replace if excessively burned. Examine condenser lead wire for breakage or loose connection. Crank engine and note whether distributor shaft turns; if not, shaft may be broken; replace distributor or notify higher authority.

(3) **IGNITION HIGH-TENSION CIRCUIT INOPERATIVE.** Remove cable from a spark plug. With the ignition switch turned on and the engine being cranked, hold the loose end of the spark plug cable about $\frac{1}{4}$ inch from the cylinder head. If current jumps from the cable to the cylinder head, the ignition circuit is complete through cable tested. Test other cables in the same manner. Test spark plugs in spark plug tester.

(4) **IGNITION PRIMARY CIRCUIT INOPERATIVE (fig. 45).** If the headlights burn fairly bright, there will be ample current in the ignition primary circuit at least as far as the ammeter. If the headlights do not burn, but the cranking motor will crank the engine, test for current through wire from cranking motor switch to ammeter. Then test primary circuit from ammeter to coil and distributor. Remove the distributor cap and rotor and turn the engine until the distributor breaker points are definitely closed. Turn on the ignition switch and push the breaker points apart with finger. If there is a slight arc of current as the points open, the primary circuit is complete and will function if the points make and break properly when the engine is cranked. If no current is indicated by making and breaking contact of the breaker points when the ignition switch is on, turn the engine until the breaker points are open and connect the negative lead from a voltmeter to any part of the chassis that will provide a definite ground, and make the following tests:

(a) Test the wire and connections between the ammeter and the ignition switch by holding the positive lead from the voltmeter against the left post of the ignition switch. If approximate battery voltage is shown on the voltmeter, the circuit is complete to the switch.

(b) Test the switch by moving the voltmeter positive lead to the right post of the switch. If about the same voltage is shown, current is passing through the switch.

(c) Test primary wires and connections from ignition switch through radio filter to the coil by moving the voltmeter positive lead to the lower left post of the coil. If battery voltage is again shown, current is reaching that post.

3/4-TON 4 x 4 TRUCK (DODGE)

(d) Test primary circuit from coil to distributor breaker points by moving the voltmeter positive lead to the lower right post of the coil, to each side of the distributor filter (if so equipped) and finally to the distributor breaker arm. If battery voltage is shown at any of these points of test and not at the next point, the trouble will be located between these two points. If very little or no voltage is shown at any point between the coil and breaker arm, disconnect the condenser lead wire from the distributor body and connect the voltmeter positive lead to the breaker arm. A normal battery voltage reading then would show a shorted condenser. No voltage reading at any of the points between the coil and breaker arm (with the breaker points open and the condenser lead disconnected), would indicate a broken primary circuit in the coil.

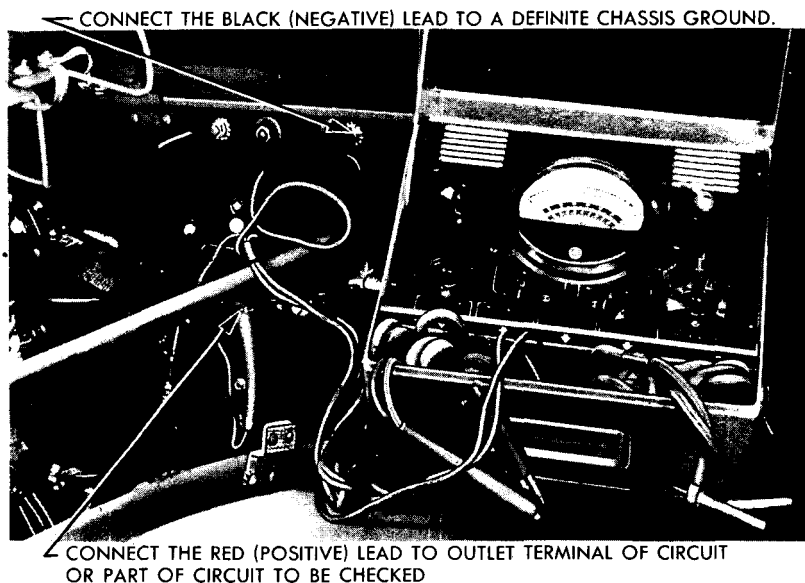

RA PD 52936

Figure 45—Checking Ignition Primary Circuit**39. BATTERY AND GENERATING SYSTEM.**

a. **General Information.** All tests described below to determine causes of trouble in the battery and generating system are based on the use of the low voltage circuit tester (17-T-5575). This tester contains a voltmeter, ammeter, and switches, for making the various tests described.

(1) **TESTER CONNECTIONS** (fig. 46). A diagram of the connections for the low voltage circuit tester is shown on a plate attached to the cover of the tester. Make all connections shown except those for the field rheostat. Use this hookup only when making test described in

TROUBLE SHOOTING

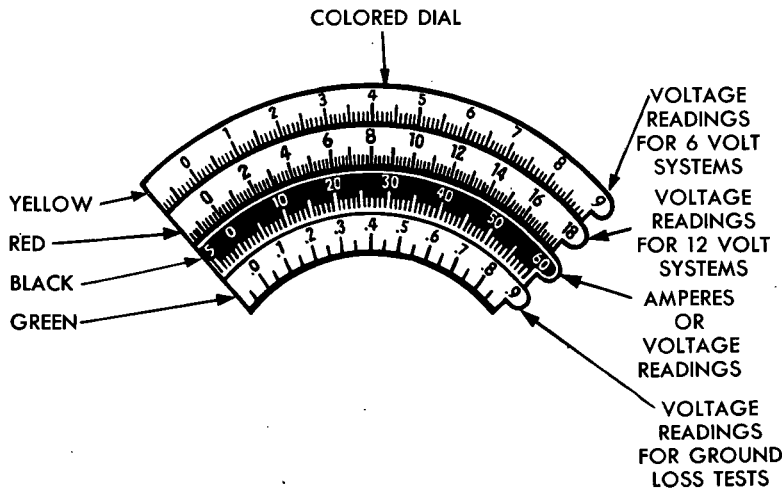
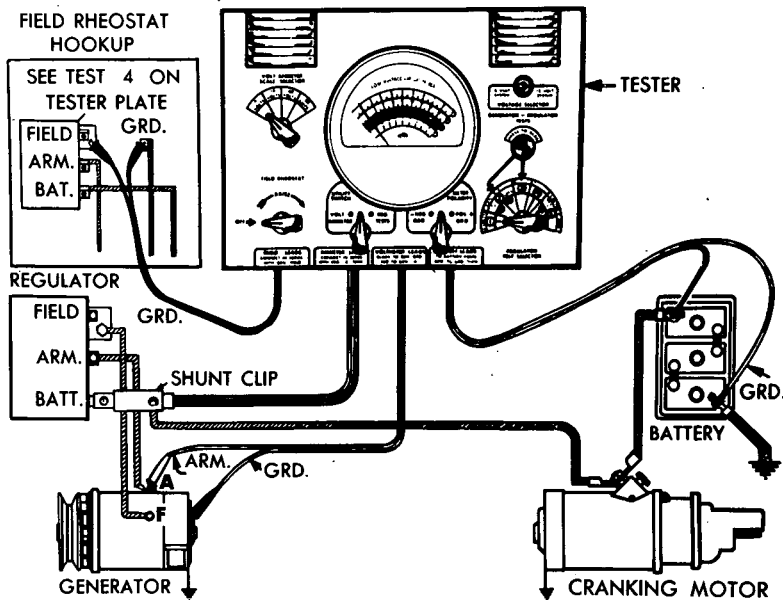

RA PD 312548

Figure 46—Test Connections for Low Voltage Circuit Tester

3/4-TON 4 x 4 TRUCK (DODGE)

subparagraph i which follows. Place knob of voltage selector switch at 6 or 12 volts, depending on the electrical system voltage of the vehicle being checked. The voltage can be determined by examining the name plate attached to the generator or regulator cover. The plate for 6-volt systems is red; for 12-volt systems, green. Turn utility switch to "Regulator Tests" position. Turn meter polarity switch to suit ground polarity of vehicle being checked. (All vehicles covered by this manual are equipped with negative ground electrical systems.) Place regulator test selector switch in "No. 1" position. Connect the ammeter test leads in series with regulator terminal marked "BAT" and connect the shunt clip to that terminal. Move

SWITCH POSITION NO. 1
BATTERY VOLTS WITH STARTER LOAD

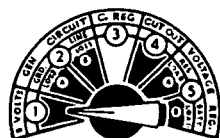

REGULATOR TEST SELECTOR

BATTERY LEADS
TO BATTERY POSTS
GRD. TO GRD. TERM.

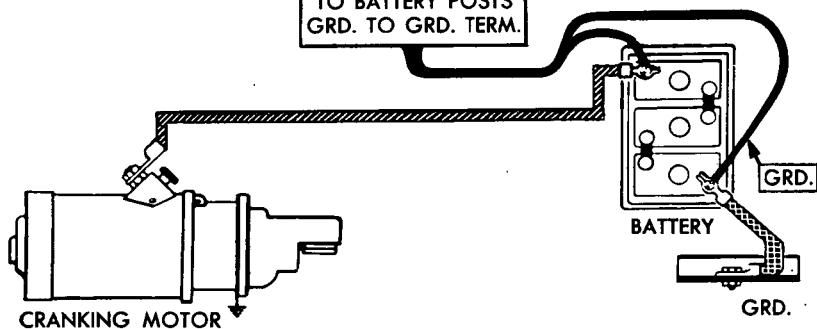

RA PD 318328

Figure 47—Battery Test

the horn feed wire to one side. Then connect the wire just removed from regulator terminal marked "BAT" to the end terminal of shunt clip. This is important as the shunt clip must be in series with circuit to be tested. The shunt clip contains a built-in meter shunt to which the tester is calibrated. Connect voltmeter test lead tagged "ARM" to armature terminal (largest terminal) of the generator and the lead tagged "GRD" to generator frame. Connect battery lead marked "GRD" to ground (negative) post of battery and the other lead to positive battery post. These connections must be made by driving the pins securely into the center of the battery posts in order to make a good connection. False readings will be obtained if the connections are not tight.

TROUBLE SHOOTING

(2) **ENGINE TEMPERATURE.** In order to make accurate tests of generator output and battery voltage, run the engine long enough to establish normal operating temperature (about 145°F) especially in cold climates, because all test specifications given are based on normal engine operating temperatures.

b. Test Battery (fig. 47).

(1) **GENERAL.** Battery condition affects generating system operation. An old battery, one partially charged or one subjected to

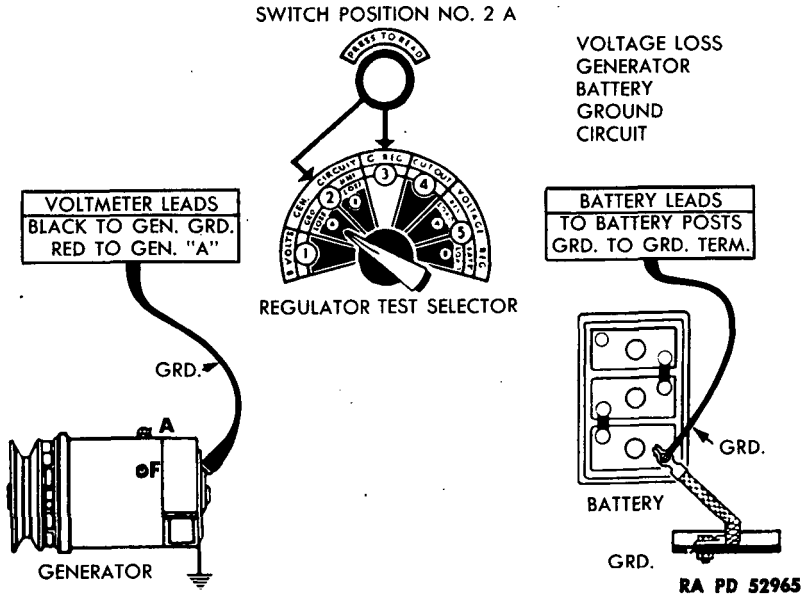

Figure 48—Voltage Loss Test (Generator and Battery Ground Circuit)

excessive heat will cause a high charging rate; while one subjected to excessive cold, hard plates, high resistance separators, and sulphation will cause a low charging rate. If there is any doubt about the condition of the battery, substitute temporarily for test purposes, a battery of the same size and capacity known to be fully charged and in good condition.

(2) **TEST PROCEDURE.** Place regulator test selector switch in "No. 1" position and operate the cranking motor with ignition off. The voltage should not drop below 5.01 volts on 6-volt systems (read yellow scale), or 10.02 volts on 12-volt systems (read red scale) while cranking the engine. If the voltage drops below these limits, check the gravity of the electrolyte in each battery cell. A variation of more than 20 points between cells indicates a defective battery. If the gravity of all cells is alike, but below 1.270 (1.225 in hot climates, par. 88), a partially charged battery is indicated and the battery

3/4-TON 4 x 4 TRUCK (DODGE)

should be recharged. A voltage reading below 4.5 volts on 6-volt systems, or 8.5 on 12-volt systems, with the cranking motor cranking the engine, usually indicates a discharged or defective battery. If the battery is fully charged and in good condition, however, the cranking motor may be the cause of excessive voltage drop. See paragraph 34 b.

(3) POSSIBLE CAUSES OF DISCHARGED BATTERY.

- (a) Excessive use of cranking motor, or electrical accessories.
- (b) Ignition switch left on with engine not running.

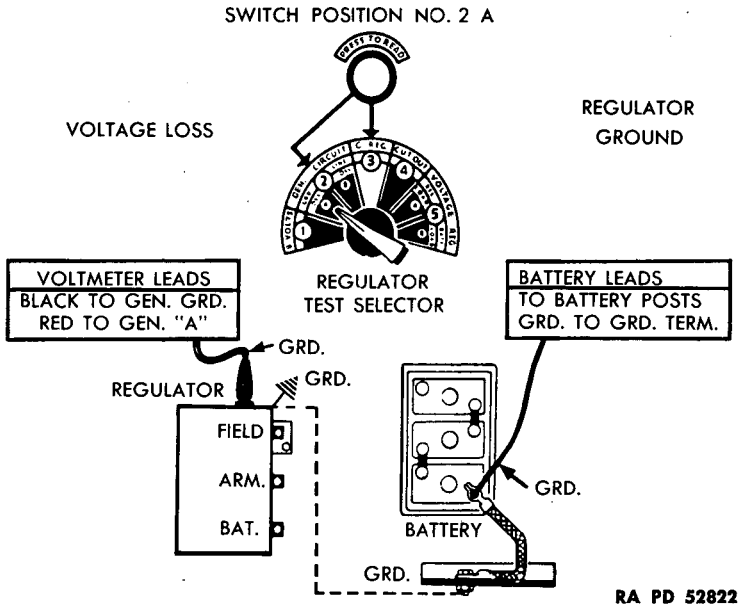

RA PD 52822

Figure 49—Voltage Loss Test (Regulator Ground Circuit)

- (c) Broken or loose fan belt.
- (d) Short circuits or voltage loss which will be determined on tests which follow.
- (e) Improper operation of generator regulator which will be determined by tests which follow.
- (f) Generator not charging due to improper operation of the generator which will be determined by tests which follow.
- (g) Battery in such condition that it will not take or hold a full charge.

c. Voltage Loss Test (Generator and Battery Ground Circuit) (fig. 48).

(1) **TEST PROCEDURE.** Place regulator test selector switch in "No. 2A" position. Run engine at about 2,000 revolutions per minute

TROUBLE SHOOTING

(approximately half speed), then press black push button marked "PRESS TO READ." The meter reading should not exceed 0.05 volt (one division) on the green scale if the ground circuit is in good condition. A reading higher than this indicates a loss of voltage due to poor ground connections.

(2) POSSIBLE CAUSES OF VOLTAGE LOSS IN GENERATOR AND BATTERY GROUND CIRCUIT.

(a) Poor contact between generator housing and engine due to accumulation of grease, paint, or rust.

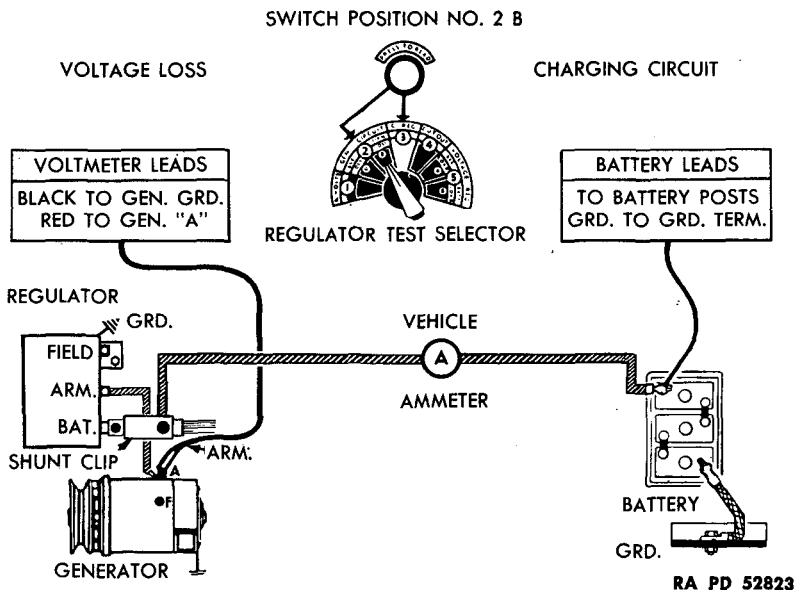

Figure 50—Voltage Loss Test (Charging Circuit)

(b) Battery ground cable corroded or loose.

(c) Generator charging rate too high, causing increased voltage loss in proportion to excessive charging rate. This will be determined on tests which follow.

d. Voltage Loss Test (Regulator Ground Circuit) (fig. 49).

(1) TEST PROCEDURE. Leave regulator test selector switch in "No. 2A" position with the engine running. Disconnect the voltmeter "GRD" test cable which was connected to the generator frame and connect it to the regulator base and again press the black button. Reading should not exceed 0.05 volt (one division) on the green scale. A higher reading indicates voltage loss in the regulator ground

3/4-TON 4 x 4 TRUCK (DODGE)

circuit. NOTE: After completing this test, leave "GRD" cable in this position for all succeeding tests.

(2) POSSIBLE CAUSES OF VOLTAGE LOSS IN REGULATOR GROUND CIRCUIT. Poor ground at either end of wire shielding at regulator and generator. Tighten wire shielding securely and repeat test.

e. Voltage Loss Test (Charging Circuit) (fig. 50).

(1) TEST PROCEDURE. Determine charging rate (subpar. f below). Place regulator test selector switch in "No. 2B" position with the engine running. Press the black button and note voltage loss on the

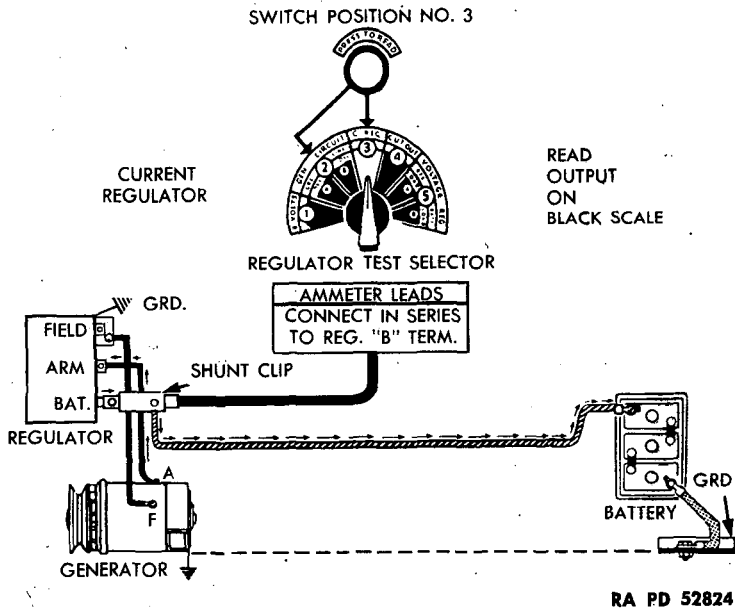

Figure 51—Current Regulator Test

yellow scale. Maximum loss should not exceed 0.35 volt for each 10 amperes of current flowing in the circuit.

(2) POSSIBLE CAUSES OF VOLTAGE LOSS IN CHARGING CIRCUIT.

(a) Damaged battery cable, loose or corroded terminals or connections between positive battery post, generator and regulator.

(b) Loose or corroded connections at ammeter; or high internal resistance in ammeter. To test ammeter, place a jumper wire across ammeter and repeat test.

(c) Internal trouble within the generator regulator assembly itself.

(d) Use of undersize replacement cables or wires between battery, generator and regulator.

TROUBLE SHOOTING

(e) Generator charging rate too high, causing increased voltage loss in proportion to excessive charging rate.

f. **Current Regulator Test** (fig. 51). Set regulator test selector switch to "No. 3" position. Run engine at about 2,000 revolutions per minute and press the black push button. Note charging rate (amperes) on black scale. Charging current should approximately coincide with the rated capacity of the generator as shown on rating plate on regulator. If charging current is higher or lower than capacity of generator, the fan belt is loose or the current regulator is incorrectly set. If no charge, or a low charge is indicated, make

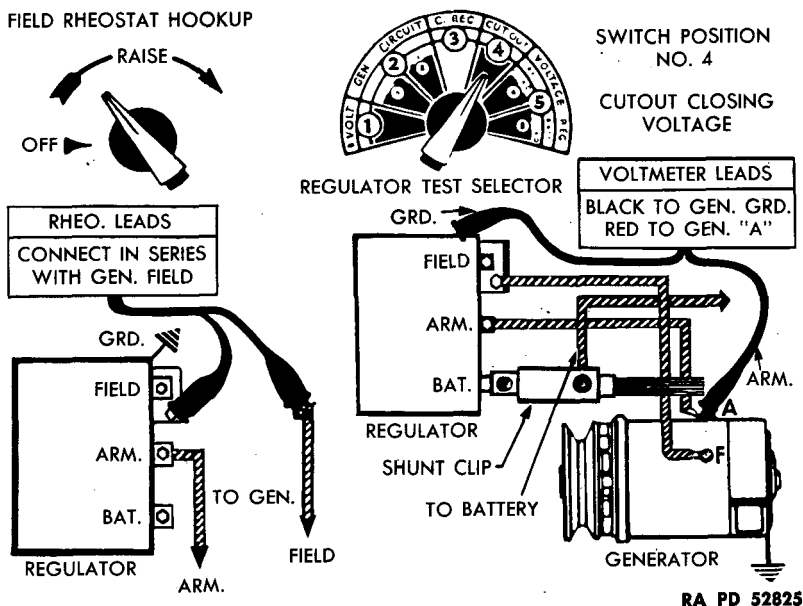

Figure 52—Circuit Breaker Closing Voltage Test

the following test to determine whether the generator or generator regulator is at fault. Connect a jumper between "A" and "F" terminal regulator and operate the engine at slow speed. Under this condition the generator may produce a dangerously high output if the speed is carried too high, and if run for too long a period of time, may result in burned armature or field.

(1) If the ammeter indicates no amperage is flowing in the circuit, it will be necessary to take a voltage reading to determine whether the generator or the regulator is at fault. To take a voltage reading, place the utility switch in the "volt-ammeter" position. Turn the volt-ammeter scale selector to "18 VOLTS" range. **NOTE: Operate the engine at slow speed, as too high a speed may damage generator armature or field, as explained in subparagraph f above.**

3/4-TON 4 x 4 TRUCK (DODGE)

(2) If the voltmeter (red scale) indicates a voltage in excess of 8.0 volts for 6-volt systems or 15.0 volts for 12-volt systems, the generator is functioning properly and the fault is in the generator regulator.

(3) With no voltage indication or with a voltage reading below 6.4 volts for 6-volt systems or 13.0 volts for 12-volt systems, the generator is at fault. After making this test, remove jumper wire across "A" and "F" terminals and change utility switch and voltmeter scale selector back to original setting for all succeeding tests.

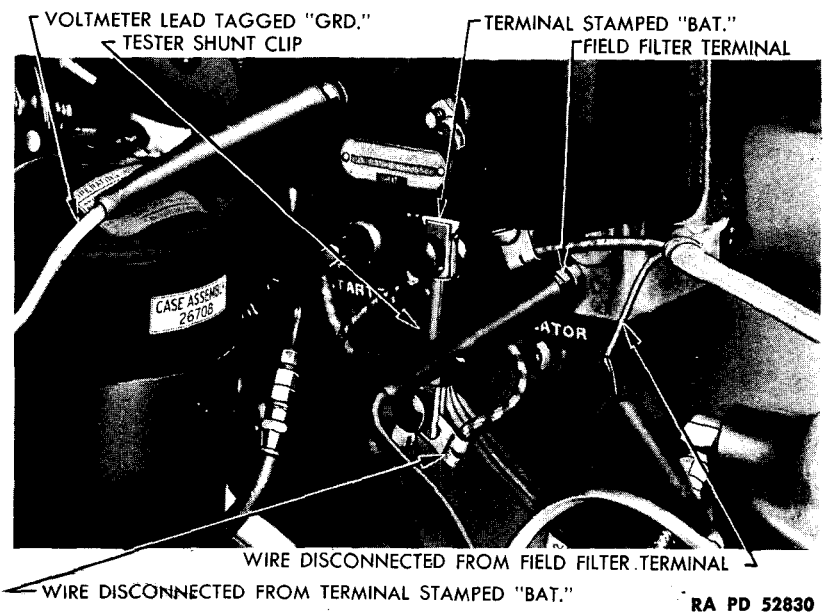

Figure 53—Field Rheostat Connections

g. **Circuit Breaker Reverse Current Test** (fig. 51). Leave regulator test selector in "No. 3" position. Gradually reduce engine speed and note reverse current on the black scale. If the circuit breaker is opening properly, the reverse current should not exceed 0.5 to 4.0 amperes (6-volt systems) or 0.5 to 6.0 amperes (12-volt systems) before the points open and reverse current stops. It may be necessary to stop the engine and read the discharge current as the engine slows down to a stop. If it is known that the circuit breaker is not functioning properly, replace the generator regulator assembly.

h. **Circuit Breaker Closing Voltage Test** (figs. 52 and 53). Place regulator test selector switch in "No. 4" position. Connect field rheostat in series with the field terminal of the generator at the

TROUBLE SHOOTING

regulator as shown in figure 53. The field rheostat is provided for controlling the voltage of generators at idling speed to check the circuit breaker closing voltage. Maintain engine speed at fast idle. Then gradually increase generator output with field rheostat by rotating knob in the direction of arrow until meter pointer kicks back slightly. The position on the dial where the meter pointer kicks back and remains steady is the closing voltage which should be 6.4 to 6.8 volts for 6-volt systems (read yellow scale) or 12.8 to 13.6 volts for 12-volt systems (read red scale). **CAUTION:** *Circuit breaker closing voltage should always be above that of the battery and at least 0.5 volt under voltage setting of generator regulator.* If the setting is incorrect, replace regulator.

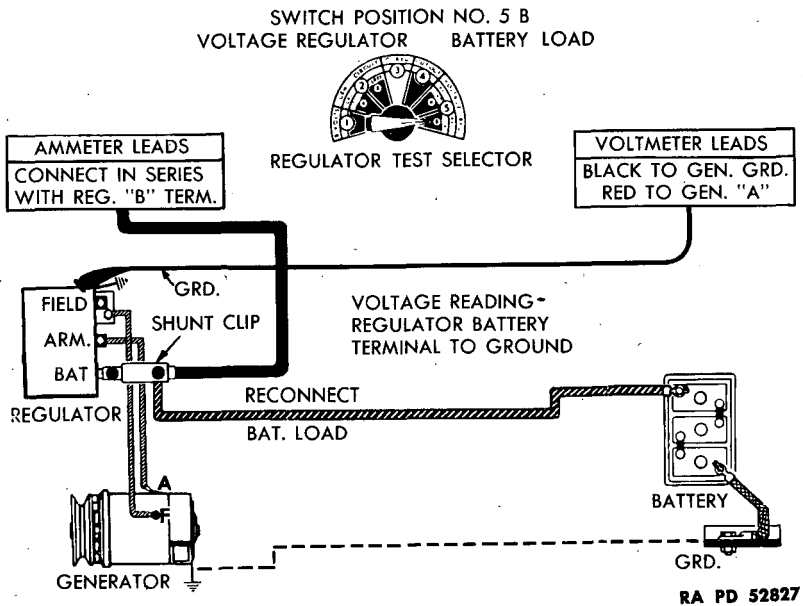

Figure 54—Voltage Regulator Test

i. **Voltage Regulator Test** (figs. 51 and 54). Disconnect the field rheostat used in previous test (subpar. h above) and reconnect the field terminal at the regulator. Set regulator test selector switch in "No. 3" position (fig. 51) and run engine at about 2,000 revolutions per minute for approximately 15 minutes with the hood closed, as engine and regulator must be at normal operating temperature to make accurate tests. Run engine until the charging rate drops below 15 amperes, as battery must be fully charged for accurate check. Then move regulator test-selector switch to "No. 5B" position (fig. 54). Read the yellow scale for 6-volt systems or the red scale for 12-volt systems. The voltage should check within 7.2 to 7.3 volts for the 6-volt systems and 14.3 to 14.5 volts on the 12-volt systems

3/4-TON 4 x 4 TRUCK (DODGE)

at normal room temperature. If the voltage does not check within these limits, replace generator regulator assembly.

40. LIGHTING SYSTEM.

a. General Information. If the engine cranks and starts there will be current in the lighting circuit at least as far as the ammeter, and light failure will be caused by some difficulty in the lighting circuit, lights, bulbs or switches. (See wiring diagram in sec. XXV.)

b. All Lights Inoperative (with Main Lighting Switch On).

(1) **FEED WIRE DISCONNECTED FROM CIRCUIT BREAKER.** The circuit breaker is mounted on the main lighting switch. Connect wire.

(2) **CIRCUIT BREAKER POINTS NOT MAKING CONTACT.** If points do not make contact, replace circuit breaker.

(3) **ALL LIGHT BULBS BURNED OUT.** Replace bulbs.

(4) **MAIN LIGHTING SWITCH INOPERATIVE.** If causes listed under steps (1) through (4) are not evident, replace the main lighting switch.

c. One Light Inoperative.

(1) **BULB BURNED OUT.** Replace bulb.

(2) **POOR GROUND BETWEEN LIGHT ASSEMBLY AND MOUNTING.** Clean mounting surfaces and tighten mounting nuts.

(3) **FEED WIRE LOOSE, BROKEN, OR DISCONNECTED.** Inspect connections at light, terminal block on frame side member, junction block and main lighting switch. If connections are clean and tight, test feed wire from switch to light for current and, if broken, replace affected wiring assembly (sec. XXVI).

d. Circuit Breaker Clicking (Lights Flash Off and On).

(1) **SHORT CIRCUIT IN WIRING TO LIGHTS.** Watch each light that should be operating. The light not operating at intervals indicates the circuit in which a short circuit exists. Inspect connection at inoperative light for feed wire contacting light body. If headlight is inoperative, clean and inspect terminal block on frame front cross member. If trouble cannot be corrected at light end of feed wire, disconnect the same color wire from the junction block. If other lights then burn steadily, the feed wire in the lower wiring assembly is grounded. Replace wiring assembly (par. 127). Temporary repairs can be made by leaving both ends of the grounded wire disconnected and running another wire from junction block to light connection.

e. Lamp Bulbs or Sealed Beam Units Fail Repeatedly.

(1) **GENERATOR REGULATOR INADEQUATELY GROUNDED.** Tighten wiring shielding to regulator base and generator.

(2) **GENERATOR REGULATOR IMPROPERLY ADJUSTED.** Test regulator (par. 39) and replace if faulty.

f. Sealed Beam Unit or Bulb Burns Out Immediately After Installed with Light Switch On.

(1) **SIX-VOLT BULB USED WITH 12-VOLT SYSTEM.** Install correct bulb (par. 104).

TROUBLE SHOOTING

(2) **GENERATOR REGULATOR NOT CONTROLLING CHARGING RATE.**
Test regulator (par. 39) and replace if faulty.

g. Headlights Dim.

(1) **HEADLIGHTS IMPROPERLY AIMED.** Aim (par. 105).

(2) **LOW VOLTAGE AT HEADLIGHT** (fig. 55). Lighting system voltage may be checked with the low voltage circuit tester. Change the tester controls so that the instrument can be used as a voltmeter.

(a) Remove the headlight door and partially pull out the sealed beam unit from the wire connector. With the sealed beam unit mounted in its correct position, the top prong supplies current for the low beam. The right prong supplies current for the high beam and the left prong is the ground connection. Connect the negative lead of the voltmeter to the ground connection in the headlight

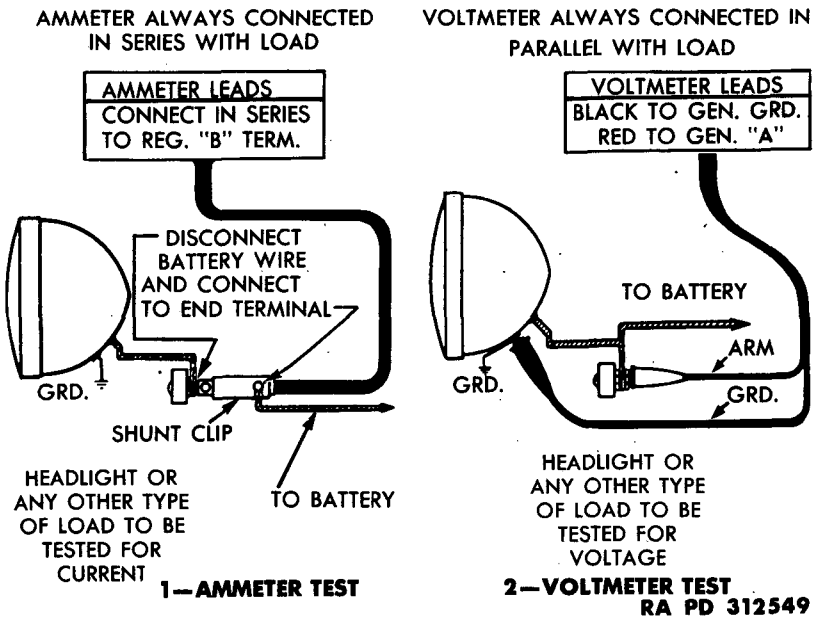

Figure 55—Volt-ammeter Tests

body and the positive voltmeter lead to the right prong which supplies current for the high beam.

(b) After the lights have burned for five minutes (engine not running), the voltage at the headlights, with the high beam filament burning, should not be less than 5.25 volts on vehicles with a 6-volt battery or less than 10.5 volts on vehicles with a 12-volt battery. With the lights burning, and the engine warmed up and running at a speed equivalent to a vehicle speed of about 20 miles per hour, the voltage at the headlights should not be less than 6.3 volts with 6-volt battery or 12.6 volts with 12-volt battery; nor more than

3/4-TON 4 x 4 TRUCK (DODGE)

6.9 volts with 6-volt battery or 13.8 volts with 12-volt battery, with battery and generator at room temperature of approximately 70°F.

(c) If voltage is low at either headlight socket, with only standard equipment in the circuit, test voltage output of battery—it should be 6.0 to 6.5 volts with 6-volt battery (12.0 to 13.5 volts with 12-volt battery). Clean and tighten battery terminals and ground cable. Check wires and connections to all lamps, also main lighting and blackout switch and headlight beam control switch for high resistance.

(d) When a voltmeter is placed between the ground and input side of a switch and then between the ground and output side of the switch, with the lights burning, the difference in the readings will represent the voltage drop in the switch. The same method may be used in checking voltage drop in wires by taking a reading at each end of the wire. If a switch shows a voltage drop of more than two-tenths of a volt or a wire connection shows a voltage drop of one-tenth of a volt, replace the switch or wire. If any wire in the lighting circuit has been replaced with other than standard equipment wire, it may lack capacity and cause voltage drop.

(3) **SEALED BEAM UNIT DEFECTIVE.** Replace unit.

41. INSTRUMENTS, GAGES, HORN, HEATER, AND ROOF VENTILATOR.

a. Fuel Gage Inoperative.

(1) **INSTRUMENT PANEL UNIT INOPERATIVE.**

(a) Disconnect the wire from the left side of the unit and connect a temporary jumper wire to the terminal. If the gage shows full, with the ignition switch on and the loose end of the jumper wire grounded, the wiring or the tank unit is at fault.

(b) If the instrument panel unit does not register full when test (a) above is made, connect another temporary wire between the right side of the gage unit and the right post of the ignition switch. If the gage does not register full, with the ignition switch on and the temporary wire from the left side of gage unit grounded, replace the fuel gage instrument panel unit (par. 72).

(2) **TANK UNIT INOPERATIVE.** If test (1) (a) above proved that the instrument panel unit is operating, disconnect wire from the tank unit and ground the wire to bare metal of the chassis. If the gage does not show full, with the ignition switch on and the tank unit wire grounded, the wire is broken. If the gage does show full, replace the fuel gage tank unit (par. 72).

b. Oil Gage Inoperative.

(1) **NO OIL PRESSURE.** See paragraph 33 n.

(2) **SMALL ORIFICE IN GAGE CONNECTION CLOGGED WITH DIRT OR ICE.** Remove connection, blow out, clean, and dry thoroughly.

(3) **GAGE DAMAGED.** Replace (par. 117).

TROUBLE SHOOTING**c. Thermometer Inoperative.**

(1) THERMOMETER HEAD, TUBE OR BULB DAMAGED. Replace (par. 118).

d. Speedometer Does Not Register Speed or Mileage.

(1) SPEEDOMETER CABLE BROKEN. Replace (par. 119).

e. Speedometer Registers Either Speed or Mileage, But Not the Other.

(1) SPEEDOMETER HEAD INOPERATIVE. Replace (par. 119).

f. Horn Does Not Operate.

(1) WIRE CONNECTOR BETWEEN HORN AND STEERING COLUMN PULLED APART. Push connector together.

(2) HORN WIRE DISCONNECTED FROM HORN BUTTON. Remove horn button and resolder wire.

(3) HORN FEED WIRE LOOSE OR DISCONNECTED. Tighten or connect wire.

(4) HORN OUT OF ADJUSTMENT. Adjust (par. 120).

g. Horn Operates Continually. To temporarily stop continuous horn operation, pull connector at bottom of steering gear apart. Leave rubber insulator on wire leading to horn.

(1) HORN BUTTON STUCK OR GROUNDED. Remove button and repair or replace (par. 120).

(2) HORN WIRE GROUNDED IN STEERING COLUMN. Replace horn button and wire (par. 120).

h. Heater Motor Does Not Run (Ambulance).

(1) FEED WIRE CONNECTION LOOSE AT HEATER OR HEATER SWITCH. Inspect and tighten wire connections.

(2) HEATER SWITCH INOPERATIVE. Replace (par. 121).

(3) HEATER MOTOR INOPERATIVE. Replace (par. 121).

i. Heater Does Not Supply Normal Amount of Heat.

(1) TEMPERATURE OF ENGINE COOLING SOLUTION BELOW 150°F. Test engine cooling system thermostat for proper operation (par. 84).

(2) HEATER SHUT-OFF VALVE AT CYLINDER HEAD CLOSED. Open shut-off valve.

(3) HEATER RADIATOR AIR-BOUND. Bleed air from heater (par. 121).

j. Heater Defroster Does Not Function.

(1) DEFROSTER BLOWER DOES NOT RUN. Tighten wire connections at defroster and switch. If blower then does not operate, replace switch or defroster (par. 121).

(2) DEFROSTER OUTLET TUBES DISCONNECTED. Connect tubes.

k. Roof Ventilator Does Not Run.

(1) WIRE CONNECTION LOOSE AT VENTILATOR OR SWITCH. Tighten or connect wires.

(2) VENTILATOR SWITCH INOPERATIVE. Replace ventilator switch (par. 122).

(3) VENTILATOR ASSEMBLY INOPERATIVE. Replace (par. 122).

3/4-TON 4 x 4 TRUCK (DODGE)**42. RADIO INTERFERENCE SUPPRESSION.**

a. **Causes of Interferences.** Electrical interference of the type to be dealt with by suppression on the vehicle has two general causes. It may be caused by sparks in the normal operation of the vehicle's ignition system or the generator or voltage regulator. It may be a static discharge between component parts of the vehicle, especially the body and its attachments, while the vehicle is in motion or for a brief period after it comes to a halt. In either case it may be recognized by the type of noise it causes in the radio receiver. **NOTE:** *If radio interference is repeated during operation, the driver will cooperate with the radio operator in locating its sources (par. 42).*

b. Location and Possible Elimination of Interference.

(1) **STATIC INTERFERENCE.** If the interference is in the form of a "frying" or "scratching" sound or irregularly spaced "pops" or "clicks" which stop when the vehicle (engine running) comes to a halt, or shortly after, it is probably caused by static discharges between component parts of the vehicle. This type of interference is eliminated by bonding, which consists of grounding or electrically connecting the various vehicle components. Bonding-braid straps are used in making this connection. Make sure that both ends of bonding straps are thoroughly clean and securely fastened. When replacing a bonding strap or when tightening a loose strap, remove all grease and dirt from the end of the strap, then thoroughly scrape it so that it will make a good electrical connection or, if available, use a toothed lock washer between the parts. Clean all nuts and washers used in fastening the strap and replace them in exactly the same position as originally found. Bonding straps should be found at the following locations:

- (a) Front fenders to splash aprons at rear.
- (b) Headlights to frame.
- (c) Hood bumper to lower hood section.
- (d) Hood, across center hinge and to cowl.
- (e) Lower hood sections to upper hood sections.
- (f) Ignition coil and steering column to dash.
- (g) Splash shield to frame.
- (h) Steering column to instrument panel.
- (i) Throttle rod, thermostat cable, speedometer cable, choke rod to dash.
- (j) Body to rear bumperette (Ambulance and Carryall).
- (k) Battery tray to splash shield and generator cable shielding to battery hold-down bolt (Weapon Carrier and Ambulance).
- (l) Cylinder head to dash at rear of head.
- (m) Frame to motor support (clutch housing), right side.
- (n) Cab to frame, both sides.
- (o) Rear of body to chassis, both sides.

(2) Bonding is also formed by use of toothed lock washers in many other places on the vehicle, particularly in the fastening of

TROUBLE SHOOTING

sheet metal and electrical units. This type washer "bites" into metal surfaces and forms a good ground. Be sure to install washers of this type in their original positions. See figures 112 through 120 for location of all bonds.

(3) **IGNITION AND GENERATING SYSTEM INTERFERENCE.** If interference is present in the receiver when the vehicle is stationary with the engine running, it is probably due to improper suppression of sparks involved in the operation of the engine or generator. Suppression filters and condensers are used at or near the point of origination to eliminate or at least reduce interference (par. 103). The following steps should be taken to determine causes of ignition or generating system interference:

(a) Clean and tighten battery terminals. Replace cables if damaged due to corrosion.

(b) Clean spark plugs and adjust gaps to 0.025 inch.

(c) Clean distributor cap if dirty; replace if cracked.

(d) Inspect distributor rotor; replace if burned or cracked.

(e) Inspect and clean distributor breaker points; adjust to 0.020 inch.

(f) Inspect resistor-suppressors installed on each of the six spark plug wires at plugs; also resistor-suppressor installed in high-tension wire connected to center terminal of distributor cap. Remove any moisture present by wiping dry with cloth; if corrosion or oxidation is present, clean and scrape. Test by substituting suppressors known to be satisfactory; if faulty, replace. Screw suppressors firmly on wires to completely seat connections.

(g) Test ignition coil; replace if faulty.

(h) Inspect and clean generator commutator and brushes.

(i) Inspect shielding on generator armature and field wires for frayed, broken, or loose connections; inspect for broken or damaged wires between generator and regulator; tighten shielding ground connections or replace wires.

(j) Inspect for loose ground or terminal connections at filter and regulator; tighten connections and mounting bolts.

(k) Inspect for broken wires in generator and ignition circuits; repair or replace.

(l) Inspect switches for faulty contacts; replace if faulty.

(m) Inspect filters for shorted or open circuits. Test for continuous circuit by connecting test unit to each terminal of filter. If current does not pass through filter, an open circuit is indicated; replace filter with identical new part. Test for short by disconnecting wiring from filter and connecting test unit from either terminal to filter body. Passage of current between terminal and body indicates a short within filter; replace unit. This same procedure can be used to test condensers.

3/4-TON 4 x 4 TRUCK (DODGE)**43. CLUTCH.****a. Clutch Chatter.**

(1) **GREASE ON DISK, FLYWHEEL, OR PRESSURE PLATE.** Replace disk (par. 131) and thoroughly clean other parts.

(2) **BINDING OF CLUTCH RELEASE LINKAGE.** Clean and free up linkage.

(3) **DISK FACINGS LOOSE ON DISK.** Replace disk (par. 131).

(4) **BROKEN PRESSURE PLATE.** Replace pressure plate assembly (par. 131).

(5) **RELEASE LEVERS OUT OF ADJUSTMENT.** Replace pressure plate assembly (par. 131).

(6) **ENGINE MOUNTINGS LOOSE.** Tighten engine mounting bolts (par. 67 b).

b. Clutch Grabbing.

(1) **GREASE ON DISK, FLYWHEEL, OR PRESSURE PLATE.** Replace disk (par. 131) and thoroughly clean other parts.

(2) **CLUTCH DISK OR PRESSURE PLATE BROKEN.** Replace damaged parts (par. 131).

(3) **HUB OF DISK NOT SLIDING FREELY ON SPLINED SHAFT.** Remove and free up.

(4) **RELEASE LINKAGE BINDING.** Free up linkage.

c. Clutch Slippage.

(1) **LACK OF PEDAL FREE PLAY.** Adjust pedal free play (par. 130).

(2) **RELEASE LINKAGE BINDING.** Free up linkage.

(3) **PRESSURE SPRINGS WEAK OR BROKEN.** Replace pressure plate assembly (par. 131).

(4) **DISK FACINGS WORN.** Replace disk (par. 131).

(5) **PRESSURE PLATE WORN.** Replace (par. 131).

d. Clutch Dragging.

(1) **EXCESSIVE PEDAL FREE PLAY.** Adjust pedal free play (par. 130).

(2) **CLUTCH DISK BENT OR DISHED.** Replace disk (par. 131).

(3) **CLUTCH DISK FACINGS LOOSE OR BROKEN.** Replace disk (par. 131).

(4) **RELEASE LEVERS IMPROPERLY ADJUSTED.** Replace pressure plate assembly (par. 131).

(5) **FRICTION IN CRANKSHAFT PILOT BUSHING.** Notify higher authority.

e. Gear Clash. Gear clash caused by the spinning of the clutch is frequently confused with clutch dragging. A clutch disk which releases perfectly will naturally spin under its own weight and momentum immediately after being released, if the transmission gears are in the neutral position. When shifting from neutral to first speed, or to reverse, wait for the clutch to stop to avoid gear clash.

TROUBLE SHOOTING**44. TRANSMISSION.****a. Hard Gear Shifting.**

- (1) TOO MUCH CLUTCH PEDAL FREE PLAY. Adjust (par. 130).
- (2) CLUTCH DISK HUB BINDS ON DRIVE PINION SPLINES. Remove disk and free up (par. 92).
- (3) CLUTCH DISK OR OTHER CLUTCH PARTS DAMAGED. Replace disk or clutch pressure plate assembly (par. 131).

b. Slips Out of High Gear.

- (1) TRANSMISSION CASE NOT TIGHT ON CLUTCH HOUSING. Tighten attaching cap screws.
- (2) DIRT BETWEEN TRANSMISSION AND CLUTCH HOUSING FACES. Remove transmission (par. 133) and clean surfaces.
- (3) TRANSMISSION PARTS WORN OR DAMAGED; CLUTCH HOUSING DAMAGED. Notify higher authority.

c. Slips Out of Gear Other Than High.

- (1) TRANSMISSION INTERNAL PARTS WORN OR DAMAGED. Notify higher authority.

d. Engagement of Two Speeds.

- (1) INTERLOCK PIN OR PLUNGERS IN TRANSMISSION MISSING. Notify higher authority.

e. Lubricant Leakage.

- (1) LUBRICANT LEVEL TOO HIGH IN TRANSMISSION. Correct level is from lower edge of filler hole (hot) to $\frac{1}{2}$ inch below (cold).
- (2) LEAK AROUND BEARING RETAINER CAP SCREWS. Remove screws, dip in white lead or paint, and install.
- (3) MAINSHAFT REAR BEARING OIL SEAL WORN OR DAMAGED; GASKET AT DRIVE PINION BEARING RETAINER DAMAGED. Notify higher authority.
- (4) POWER TAKE-OFF LOOSE ON TRANSMISSION CASE. Tighten attaching cap screws.
- (5) GASKETS BETWEEN POWER TAKE-OFF AND TRANSMISSION DEFECTIVE. Notify higher authority.
- (6) POWER TAKE-OFF CASE DAMAGED; BEARING CAP GASKETS OR OIL SEALS LEAKING. Notify higher authority.

f. Power Take-off Overheats.

- (1) TRANSMISSION LUBRICANT LOW. Replenish lubricant.
- (2) IMPROPER CLEARANCE BETWEEN POWER TAKE-OFF GEAR AND TRANSMISSION GEAR; BEARINGS ADJUSTED TOO TIGHTLY. Notify higher authority.

g. Power Take-off Slips Out of Gear.

- (1) GEARSHIFT ROD IMPROPERLY ADJUSTED NOT ALLOWING FULL MESH OF GEARS. Adjust gearshift rod (par. 134).
- (2) POWER TAKE-OFF PARTS WORN OR DAMAGED. Notify higher authority.

¾-TON 4 x 4 TRUCK (DODGE)**45. TRANSFER CASE.**

a. Excessive Noise. Due to the severe operating conditions under which the vehicle must necessarily operate, the transfer case is sturdily constructed for dependability rather than for quietness of operation. Consequently, some gear noise will be audible, especially when the engine is under load with the transmission in high gear at low or medium speeds, and should be considered normal.

(1) **LUBRICANT LOW.** Replenish lubricant.

(2) **INTERNAL PARTS WORN OR DAMAGED.** Notify higher authority.

b. Hard Shifting To or From Front Axle Drive.

(1) **CONTROL LEVER SEIZED TO SUPPORT PIN ON TRANSMISSION COVER.** Free up and lubricate lever.

(2) **SHIFTER RAIL TIGHT IN CASE.** Free up rail by lubricating without disassembling.

(3) **INTERNAL PARTS WORN OR DAMAGED.** Notify higher authority.

c. Lubricant Leakage.

(1) **LUBRICANT LEVEL TOO HIGH.** Correct level is from lower edge of filler hole (hot) to ½ inch below (cold).

(2) **VENT ON TOP OF CASE CLOGGED.** Remove and clean vent.

(3) **OIL SEALS OR GASKETS LEAK; PROPELLER SHAFT COMPANION YOKE SCORED OR GROOVED; BEARINGS LOOSE OR DAMAGED.** Notify higher authority.

d. Overheating. The normal operating temperature of the transfer case is high, therefore, the assembly should not be considered as overheated unless an abnormal gear noise or lubricant leakage past the oil seals develop.

(1) **LUBRICANT LEVEL TOO HIGH OR TOO LOW.** Drain or fill to proper level.

(2) **VENT ON TOP OF CASE CLOGGED.** Remove vent and clean.

(3) **BEARINGS ADJUSTMENT TOO TIGHT.** Notify higher authority.

e. Front Axle Drive Disengages.

(1) **CONTROL ROD IMPROPERLY ADJUSTED.** Adjust rod (par. 136).

(2) **TRANSFER CASE PARTS WORN OR DAMAGED.** Notify higher authority.

f. Backlash.

(1) **TRANSFER CASE LOOSE IN MOUNTING BRACKETS.** Tighten cap screws.

(2) **PROPELLER SHAFT COMPANION YOKE LOOSE ON TRANSFER CASE SHAFT.** Notify higher authority.

(3) **TRANSFER CASE PARTS WORN OR DAMAGED.** Notify higher authority.

46. PROPELLER SHAFTS.**a. Backlash or Noise in Joint.**

(1) **CROSS BEARINGS OR YOKE WORN OR DAMAGED.** Replace propeller shaft assembly (par. 139).

TROUBLE SHOOTING

b. Lubricant Leaks from Joint.

- (1) OIL SEALS DEFECTIVE. Replace propeller shaft assembly (par. 159).
- (2) LUBRICANT FITTING LEAKS OR LOST. Replace fitting.

c. Vibration in Propeller Shaft.

- (1) WORN OR DAMAGED UNIVERSAL JOINTS; PROPELLER SHAFT SPRUNG. Replace propeller shaft assembly (par. 139).
- (2) ASSEMBLY ARROWS ON SHAFT AND SPLINED YOKES NOT IN LINE. Line up arrows (par. 139).

47. FRONT AND REAR AXLES.

a. General. The differential and carrier assemblies used in the front and rear axles are identical. Both axles are of the full-floating type (driving power through axle drive shafts).

b. Lubricant Leakage at Drive Pinion.

- (1) LUBRICANT LEVEL TOO HIGH. Correct level is from lower edge of filler hole (hot), $\frac{1}{2}$ inch below (cold).
- (2) AXLE HOUSING VENT CLOGGED. Remove and clear vent (par. 145).
- (3) PINION BEARING OIL SEAL, SLINGER, OR PROPELLER SHAFT COMPANION YOKE WORN OR DAMAGED. Notify higher authority.

c. Differential Lubricant Passes into Front Axle Universal Drive Joint Housing.

- (1) DIFFERENTIAL LUBRICANT LEVEL TOO HIGH. Drain to level of $\frac{1}{2}$ inch below filler plug hole.
- (2) AXLE HOUSING VENT CLOGGED. Remove and clear vent.
- (3) UNIVERSAL DRIVE SHAFT OIL SEAL WORN OR DAMAGED. Replace seal.

d. Lubricant Leakage into Brake Drum.

- (1) LOOSE WHEEL BEARINGS. Adjust bearings (par. 142 or 147).
- (2) WHEEL BEARING OIL SEAL (INNER) WORN OR DAMAGED. Replace oil seal (par. 142 or 147).
- (3) WHEEL BEARINGS PACKED WITH IMPROPER OR EXCESSIVE LUBRICANT. Clean and repack wheel bearings (par. 24).
- (4) FRONT AXLE ONLY: DIFFERENTIAL AND/OR UNIVERSAL JOINT LUBRICANT LEAKING PAST STEERING KNUCKLE BUSHING CAUSING EXCESSIVE LUBRICANT IN WHEEL BEARINGS. Check lubricant level in differential; if correct, replace bushing.
- (5) REAR AXLE ONLY: DIFFERENTIAL LUBRICANT LEAKING PAST WHEEL BEARING OIL SEAL (OUTER) CAUSING EXCESSIVE LUBRICANT IN WHEEL BEARINGS. Clean bearings and hub; repack with lubricant; replace oil seal (par. 147).

e. Backlash Between Propeller Shaft and Wheels.

- (1) PROPELLER SHAFT UNIVERSAL JOINT WORN OR DAMAGED. Replace propeller shaft assembly (par. 139).
- (2) PROPELLER SHAFT COMPANION YOKE LOOSE ON PINION SHAFT. Remove universal joint and tighten yoke.

3/4-TON 4 x 4 TRUCK (DODGE)

(3) **FRONT AXLE ONLY: UNIVERSAL DRIVE ASSEMBLY WORN OR DAMAGED.** Notify higher authority.

(4) **REAR AXLE ONLY: AXLE DRIVE SHAFT FLANGE LOOSE.** Tighten or replace flange nuts.

(5) **WORN OR DAMAGED PARTS IN DIFFERENTIAL CARRIER.** Notify higher authority.

f. **Noise in Axle.** Certain road surfaces cause tire noise that may seem to come from the axle. Before attempting to eliminate axle noise be sure the noise is not caused by the tires. A certain amount of gear noise in the transfer case is also normal (par. 45), and should not be confused with axle noises. Do not attempt to locate axle noise by operating the vehicle with the wheels off the ground.

(1) **LACK OF LUBRICATION.** Replenish lubricant.

(2) **WHEEL BEARINGS WORN OR DAMAGED.** Replace (pars. 142 and 147).

(3) **INTERFERENCE BETWEEN BRAKE PARTS AND WHEEL HUB OR DRUM.** Remove wheel and inspect for loose or damaged parts (par. 153).

(4) **WORN OR DAMAGED PARTS IN DIFFERENTIAL CARRIER ASSEMBLY.** Notify higher authority.

48. FOOT BRAKES.

a. **Brakes Fail Completely (Pedal Goes to Floorboard and Fails to Give Braking Effect).**

(1) **MECHANICAL LINKAGE BETWEEN PEDAL AND MASTER CYLINDER, PISTON DISCONNECTED OR BROKEN.** Connect or replace linkage.

(2) **FLUID LINE OR HOSE BROKEN.** Replace line or hose.

(3) **PISTON CUP IN MASTER OR WHEEL CYLINDER DAMAGED.** Inspect for leakage of fluid at boot on rear end of master cylinder. Inspect for leakage at wheel cylinders. Replace master cylinder (par. 155) or wheel cylinder (par. 154).

b. **Brakes Fail on First Pedal Operation but Function After Several Quick Operations.**

(1) **BRAKE SHOE CLEARANCE EXCESSIVE.** Adjust brake shoe cams (par. 151).

(2) **FLUID PASSING PISTON CUP IN MASTER OR WHEEL CYLINDER.** Inspect for leakage of fluid at boot on rear end of master cylinder. Inspect for leakage at wheel cylinders. Replace master cylinder (par. 155) or wheel cylinder (par. 154).

(3) **FLUID LINE, CONNECTION, OR HOSE LEAKING.** Tighten or replace necessary part.

c. **Hard Pedal and Poor Brakes.**

(1) **ANCHOR BOLTS IMPROPERLY ADJUSTED.** Adjust (par. 151).

(2) **BRAKE LINING WORN OR GLAZED.** Replace brake shoe and lining assemblies (par. 153).

(3) **BRAKE DRUMS EXCESSIVELY SCORED.** Replace drums (par. 153).

TROUBLE SHOOTING

d. Spongy Brake Pedal.

- (1) ANCHOR BOLTS IMPROPERLY ADJUSTED. Adjust (par. 151).
- (2) INSUFFICIENT FLUID IN BRAKE SYSTEM. Replenish and bleed brake system (par. 152).

e. Pedal Goes Slowly to Floor under Application.

- (1) FLUID LINE, CONNECTION OR HOSE LEAKING. Tighten or replace necessary part.
- (2) FLUID PASSING PISTON CUP IN MASTER OR WHEEL CYLINDER. Inspect for leakage of fluid at boot on rear end of master cylinder. Inspect for leakage at wheel cylinders. Replace master cylinder (par. 155) or wheel cylinder (par. 154).

f. Brakes Grab, Chatter, or Brake Unevenly.

- (1) GREASE OR BRAKE FLUID ON BRAKE LINING. Replace shoes and lining (par. 153).
- (2) LINING LOOSE ON SHOE. Replace shoe and lining (par. 153).
- (3) ANCHOR BOLTS IMPROPERLY ADJUSTED OR LOOSE. Adjust (par. 151).
- (4) SHOES NOT ALL EQUIPPED WITH SAME KIND OF LINING. Use shoes with one make and type of lining.
- (5) WHEEL CYLINDER PISTONS STICKING. Replace wheel cylinder (par. 154).
- (6) SPRING CLIPS LOOSE. Tighten clips.

g. Brakes Drag.

- (1) SHOES ADJUSTED TOO CLOSE TO DRUM. Adjust brake shoe cams and anchor bolts, if necessary (par. 151).
- (2) SHOE RETURN SPRING BROKEN. Replace spring (par. 153).
- (3) SHOES STICKING ON ANCHOR BOLTS. Free shoes on bolts.
- (4) WHEEL BEARINGS LOOSE. Adjust wheel bearings (par. 142 or 147).
- (5) WHEEL CYLINDER PISTON STICKING. Replace wheel cylinder (par. 154).
- (6) MASTER CYLINDER PISTON CUP HELD OVER RELIEF PORT. Check brake pedal free travel adjustment (par. 151). If there is no free travel, the master cylinder piston cup will cover relief port and brakes will not release.

49. HAND BRAKE.

a. Hand Brake Does Not Hold Parked Vehicle.

- (1) BRAKE BAND IMPROPERLY ADJUSTED. Adjust (par. 157).
- (2) BRAKE LINING WORN OR DAMAGED. Replace band and lining (par. 158).
- (3) BRAKE DRUM SCORED. Replace brake drum (par. 160).

b. Hand Brake Drags and Overheats.

- (1) BRAKE PARTIALLY APPLIED. Release lever fully.
- (2) BAND IMPROPERLY ADJUSTED. Adjust (par. 157).
- (3) LINING LOOSE AND DAMAGED. Replace band and lining (par. 158).

3/4-TON 4 x 4 TRUCK (DODGE)

50. WHEELS AND TIRES.

a. Abnormal Tire Wear.

(1) **USE OF FOUR-WHEEL DRIVE ON HARD SURFACED ROADS AND AT SPEEDS IN EXCESS OF 25 MILES PER HOUR.** Use four wheel drive only when maximum traction is needed at speeds below 25 miles per hour (par. 7).

(2) **TIRE PRESSURE LOW.** Keep tires inflated to 40 pounds pressure.

(3) **IMPROPER TOE-IN.** If front wheels, adjust toe-in (par. 141); if rear wheels notify higher authority.

(4) **WHEEL AND TIRE ASSEMBLIES OUT OF BALANCE.** Notify higher authority.

(5) **FRONT AND REAR AXLES NOT PARALLELED WITH EACH OTHER.** Inspect for broken spring center bolt; if broken, replace spring (par. 175).

(6) **DAMAGED AXLE HOUSING OR FRAME.** Notify higher authority.

51. STEERING.

a. Backlash in Steering.

(1) **DRAG LINK ENDS IMPROPERLY ADJUSTED.** Adjust drag link ends (par. 169).

(2) **STEERING GEAR (PITMAN) ARM LOOSE.** Tighten steering gear arm nut.

(3) **STEERING GEAR ADJUSTED TOO LOOSELY.** Adjust (par. 167).

(4) **WORN OR DAMAGED PARTS IN STEERING GEAR.** Notify higher authority.

b. Hard Steering.

(1) **TIRES UNDERINFLATED.** Test tire pressure with reliable gage.

(2) **LACK OF LUBRICATION.** Lubricate steering gear, knuckles and linkage (par. 24).

(3) **STEERING GEAR ADJUSTED TOO TIGHTLY.** Adjust (par. 167).

(4) **EXCESSIVE FRICTION IN STEERING POST BRACKET.** Align steering post (par. 167); if this does not correct, notify higher authority.

c. Shimmy. (An oscillating motion of the front wheels making it difficult to hold the steering wheel steady.)

(1) **UNDERINFLATED TIRES.** Inflate tires to 40 pounds pressure.

(2) **STEERING GEAR LOOSE ON FRAME.** Tighten attaching bolts.

(3) **DRAG LINK OR TIE ROD ENDS LOOSE.** Adjust link ends (par. 169) or replace tie rod ends (par. 144).

(4) **FRONT SPRING LEAVES BROKEN.** Replace springs (par. 175).

(5) **SPRING BOLTS, BUSHINGS OR SHACKLES WORN.** Replace worn parts.

(6) **SPRING CLIPS (U-BOLTS) LOOSE OR BROKEN.** Tighten or replace.

TROUBLE SHOOTING

(7) **SPRING CENTER BOLT BROKEN.** Replace spring (par. 175).

(8) **SHOCK ABSORBERS NOT FUNCTIONING.** Service shock absorbers (par. 176).

(9) **STEERING KNUCKLE FLANGE BEARINGS LOOSE; WHEEL AND TIRE ASSEMBLIES OUT OF BALANCE; AXLE HOUSING OR FRAME DAMAGED.** Notify higher authority.

d. Steering Wander. (A tendency of the vehicle to steer itself off a straight course.)

(1) **EXCESSIVE FRICTION IN STEERING MECHANISM.** Locate and eliminate excessive friction (par. 167).

(2) **WHEEL BEARINGS LOOSE.** Adjust wheel bearings (par. 142).

(3) **TOE-IN INCORRECT.** Adjust (par. 141).

(4) **STEERING KNUCKLE FLANGE BEARINGS ADJUSTED TOO TIGHTLY.** Notify higher authority.

e. Steering Dive. (A tendency of the vehicle, when turned in any direction, to turn more rapidly than intended.)

(1) **STEERING GEAR LOOSE ON FRAME.** Tighten attaching bolts.

(2) **FRONT SPRING LEAVES BROKEN.** Replace front springs (par. 175).

(3) **SPRING BOLTS, BUSHINGS OR SHACKLES WORN.** Replace worn parts (pars. 173 and 174).

(4) **SPRING CLIPS (U-BOLTS) LOOSE OR BROKEN.** Tighten or replace.

(5) **SPRING CENTER BOLT BROKEN.** Replace spring (par. 175).

(6) **AXLE HOUSING OR FRAME DAMAGED.** Notify higher authority.

52. SPRINGS AND SHOCK ABSORBERS.**a. Spring Breakage.**

(1) **EXTREMELY ROUGH HANDLING OF VEHICLE OVER ROUGH TERRAIN.** Reduce vehicle speed over rough terrain when possible.

(2) **LOOSE SPRING CLIPS (U-BOLTS).** Keep clips tightened, to prevent breakage between clips.

(3) **EXCESSIVE FRICTION AT SPRING BOLT OR SHACKLES.** Free up and lubricate bolts and shackles and adjust front shackles if too tight to prevent breakage at or near spring eye (par. 173).

(4) **LACK OF SHOCK ABSORBER CONTROL.** Service shock absorbers (par. 176).

(5) **OVERLUBRICATION OF SPRING LEAVES.** Lubricate bolts and shackles only.

b. Noise in Springs or Shock Absorbers:

(1) **SPRING SHACKLES WORN OR DAMAGED.** Replace worn or damaged parts (par. 173).

(2) **SPRING BOLTS WORN.** Replace bolt (par. 174).

(3) **SHOCK ABSORBER LINK BUSHING WORN OR DAMAGED.** Replace link and eye assembly (par. 176).

3/4-TON 4 x 4 TRUCK (DODGE)

(4) **NO FLUID IN SHOCK ABSORBERS.** Refill shock absorbers (par. 176).

c. Lack of Spring Control.

(1) **NO FLUID IN SHOCK ABSORBER.** Refill shock absorber (par. 176).

(2) **SHOCK ABSORBER LINKAGE BROKEN.** Replace link and eye assembly (par. 176).

(3) **SHOCK ABSORBER INOPERATIVE.** Replace shock absorber (par. 176).

(4) **CHASSIS SPRINGS OVERLUBRICATED.** Do not lubricate spring leaves.

53. WINCH.

a. Winch Fails to Operate.

(1) **POWER TAKE-OFF NOT ENGAGED.** Engage power take-off (par. 10).

(2) **SLIDING CLUTCH DISENGAGED.** Move clutch shifter lever to forward position and engage pin in hole.

(3) **SHEAR PIN BROKEN.** Replace (par. 169).

b. Noisy Operation of Winch.

(1) **INSUFFICIENT LUBRICATION OF CABLE DRUM SHAFT.** Lubricate through fittings (par. 24).

(2) **LUBRICANT LOW IN WORM HOUSING.** Fill housing to level of filler plug.

(3) **TOO MUCH OR TOO LITTLE CLEARANCE BETWEEN POWER TAKE-OFF AND TRANSMISSION GEARS CAUSING "HUM" OR "WHINE."** Notify higher authority.

(4) **EXCESSIVE END PLAY IN WINCH WORM SHAFT.** Notify higher authority.

Section XIV

ENGINE—DESCRIPTION, MAINTENANCE, AND ADJUSTMENT IN VEHICLE

	Paragraph
Description and tabulated data	54
Engine tune-up	55
Manifold heat control valve	56
Valves and springs	57
Cylinder head gasket	58
Manifolds and gaskets	59
Oil pan	60
Oil pressure relief valve and oil pump	61
Oil filter	62
Oil tubes (external)	63
Breather pipe air cleaner	64
Crankcase ventilator	65

54. DESCRIPTION AND TABULATED DATA.

a. General Description (figs. 56 and 57). The engine is a six-cylinder, L-head gasoline burning engine. The operating temperature of the engine is controlled by a liquid cooling system. The engine is lubricated by oil drawn from the oil pan by the oil pump and forced under pressure through drilled passages in the cylinder block to the crankshaft and camshaft bearings. Passages are drilled in the crankshaft to allow oil to be forced through the crankshaft bearings to the connecting rod bearings. A limited amount of oil is forced from the camshaft front bearing to the chain case to lubricate the timing chain and sprockets. The cylinder walls, the pistons, the piston pins, and valve tappets, are lubricated by an oil spray from the connecting rod bearings.

b. Engine Numbers. The engine number is stamped on a boss on the left side of the engine block opposite No. 1 cylinder (U, fig. 56). The letters in the circular bosses on the block are for the use of factory inspectors only, and are not to be used with the engine number.

c. Tabulated Data.

Engine type	L-head
Number of cylinders	6
Bore	3¼ in.
Stroke	45⁄8 in.
Displacement	230.2 cu in.
Compression ratio	6.7 to 1
Engine governed speed	3200 rpm
Engine firing order	1-5-3-6-2-4

3/4-TON 4 x 4 TRUCK (DODGE)

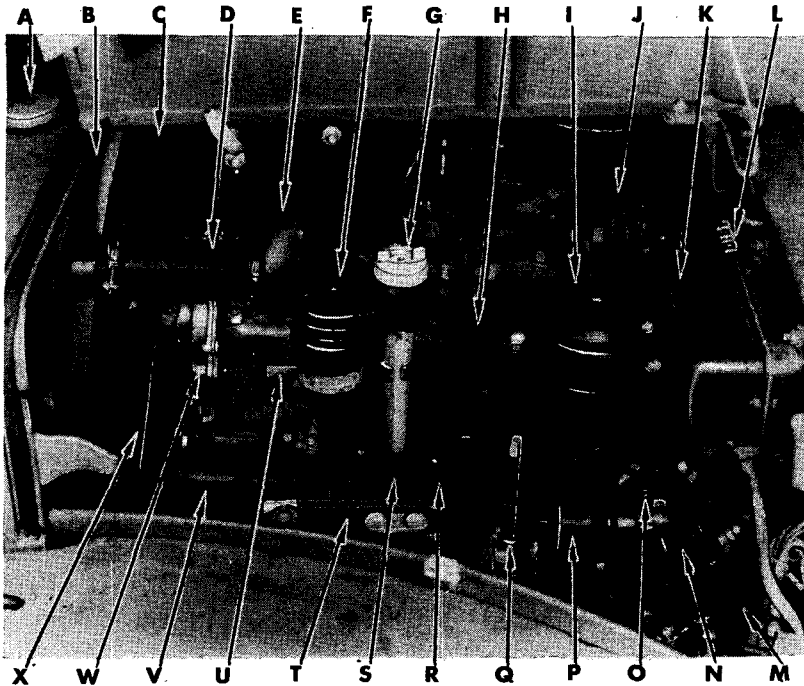

- | | |
|--|---|
| <p>A—RADIATOR FILLER CAP
 B—FAN SHROUD
 C—FAN BLADE
 D—RADIATOR INLET HOSE
 E—CYLINDER WATER OUTLET ELBOW AND THERMOSTAT
 F—BREATHER PIPE AIR CLEANER
 G—ENGINE OIL FILLER CAP
 H—IGNITION CABLE TUBE AND BRACKET
 I—ENGINE OIL FILTER
 J—HORN
 K—GENERATOR REGULATOR</p> | <p>L—CONTROL TUBE DASH GROMMET—CLAMP TYPE
 M—FUEL LINE FILTER
 N—IGNITION COIL
 O—CRANKING MOTOR SWITCH
 P—CRANKING MOTOR
 Q—OIL LEVEL INDICATOR
 R—DISTRIBUTOR
 S—BREATHER PIPE
 T—BATTERY
 U—ENGINE SERIAL NUMBER
 V—GENERATOR
 W—WATER PUMP
 X—FAN AND GENERATOR BELT</p> |
|--|---|

RA PD 312550

Figure 56—Engine—Left Side View

55. ENGINE TUNE-UP.

a. **Clean Engine.** Clean the exterior of the engine with dry-cleaning solvent.

b. **Service Air Cleaner** (par. 69).

c. **Tighten Cylinder Head, Manifolds, and Oil Pan.** Tighten the cylinder head stud nuts and cap screw, in the order shown in figure 69, to 52.5 to 57.5 foot-pounds, while the engine is warm. Tighten

ENGINE—DESCRIPTION, MAINTENANCE, AND ADJUSTMENT IN VEHICLE

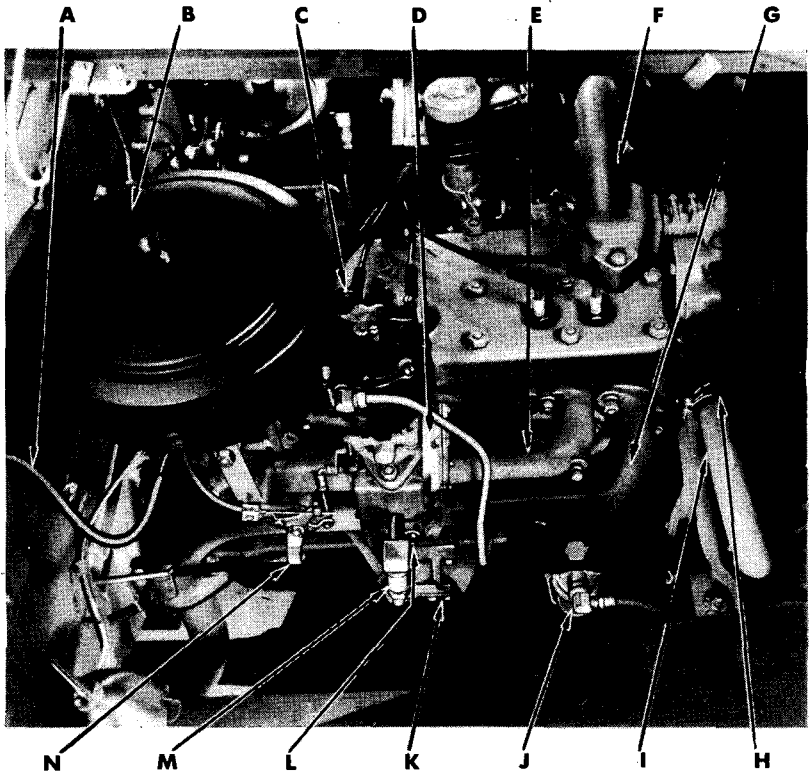

- | | |
|---|--|
| A —WINDSHIELD WIPER HOSE | H —RADIATOR WATER OUTLET HOSE |
| B —CARBURETOR AIR CLEANER | I —RADIATOR WATER OUTLET TUBE |
| C —CARBURETOR | J —FUEL PUMP |
| D —CARBURETOR GOVERNOR | K —OIL PUMP |
| E —INTAKE MANIFOLD | L —MANIFOLD HEAT CONTROL |
| F —CYLINDER WATER OUTLET ELBOW
AND THERMOSTAT | M —CRANKCASE VENTILATOR
METERING VALVE |
| G —EXHAUST MANIFOLD | N —THROTTLE CONTROL LINKAGE |

RA PD 312551

Figure 57—Engine—Right Side View

the manifold stud nuts. Tighten carburetor to manifold nuts. Tighten oil pan attaching screws.

- d. **Adjust Valve Tappets** (par. 57).
- e. **Test the Battery and Line Voltage** (par. 88).
- f. **Test Compression** (fig. 58).

(1) **PROCEDURE.** Run the engine long enough to establish normal operating temperature. If the battery is not fully charged, install a fully charged battery. Remove all spark plugs. Insert compression gage into No. 1 cylinder. Hold throttle wide open and crank

3/4-TON 4 x 4 TRUCK (DODGE)

engine with cranking motor until maximum reading is obtained. Note the compression reading of the cylinder being tested, then open the valve cap on the side of the gage to release the pressure. Repeat the operation on the other five cylinders.

(2) **INTERPRETATION OF GAGE READINGS.** Compression pressure depends upon cranking speeds, engine temperature, and compression ratio. If the compression is reasonably high (98 to 118 lb), not varying more than 10 pounds between cylinders, compression pressure can be considered normal. If the pressure in any cylinder is

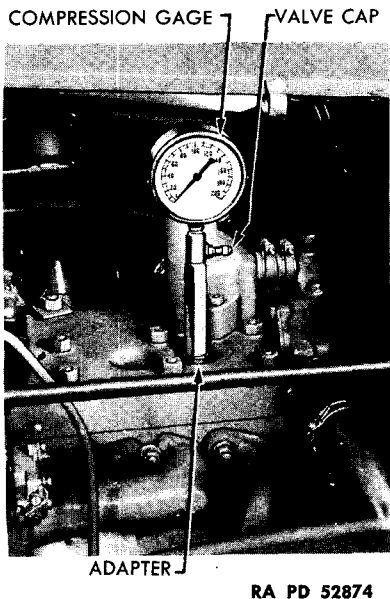

Figure 58—Compression Test

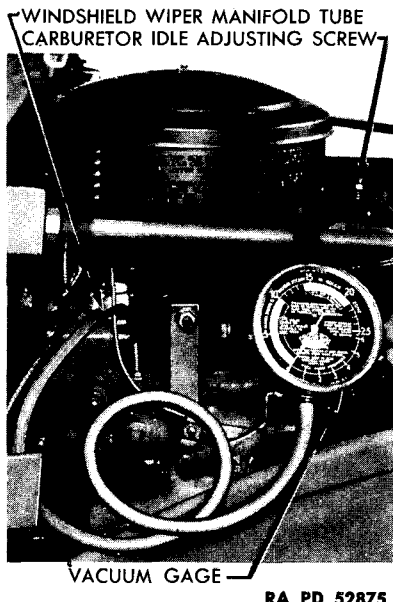

Figure 59—Vacuum Test

weak, inject oil in the spark plug hole on top of the piston with piston down. Wait a few minutes for oil to run down and seal rings and to prevent oil getting on valves. Then repeat test (subpar. (1) above). A low reading on the first test, which remains low on the second test, indicates leaky valves. A low reading on the first test, which becomes a high reading on the second test, indicates leaky rings. If either of these conditions is found, notify higher authority. An extremely low compression reading on two adjacent cylinders indicates a leaking cylinder head gasket. A gasket which has blown out between cylinders will cause erratic explosions between the two cylinders.

g. **Service Ignition System.** Clean and adjust spark plugs (par. 100). Inspect distributor breaker points and adjust or replace (par.

**ENGINE—DESCRIPTION, MAINTENANCE, AND ADJUSTMENT
IN VEHICLE**

101). Clean the distributor cap with a cloth and inspect for cracks and corrosion. Replace if either condition is found. Check the distributor rotor for cracks and corrosion or burning. Replace rotor if either of these conditions is found. Adjust ignition timing (par. 99).

h. **Test Vacuum** (fig. 59). Disconnect the windshield wiper hose at the tube leading to the intake manifold. Connect vacuum gage to the tube. Start the engine and allow it to run at idling speed. A steady reading of more than 17 inches of vacuum at sea level with a reduction of approximately $3\frac{1}{2}$ inches for each 5,000 feet altitude indicates normal performance of the engine at idling speed. Fluctu-

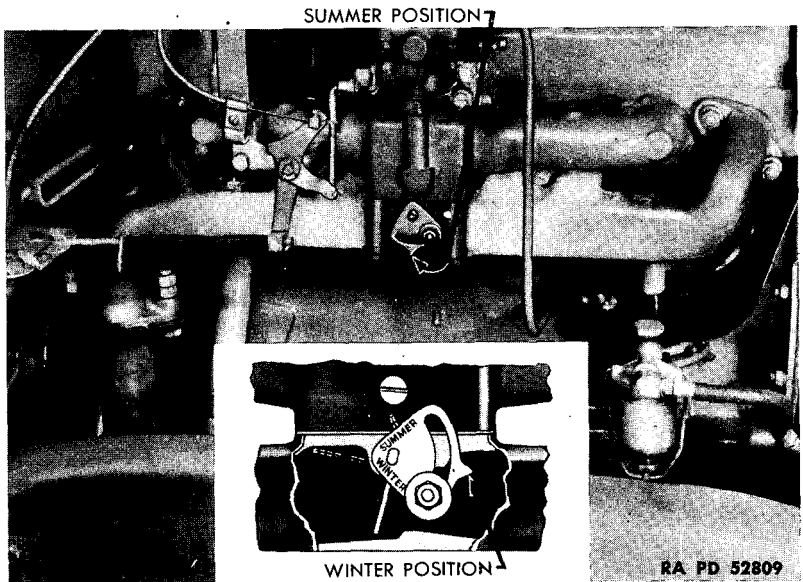

Figure 60—Manifold Heat Control

ation of the pointer of the gage indicates too rich or too lean a fuel mixture. Adjust the idle adjusting screw on the carburetor (par. 70). If this adjustment does not cause a normal reading on the vacuum gage, notify higher authority.

56. MANIFOLD HEAT CONTROL VALVE.

a. The heat control valve plate located in the exhaust manifold regulates the amount of hot exhaust gases bypassed around the intake manifold heat body. The valve plate is manually controlled. Loosen locking plate cap screw and turn position of valve plate according to season. Summer and winter positions are marked on the locking plate (fig. 60).

¾-TON 4 x 4 TRUCK (DODGE)

57. VALVES AND SPRINGS.

a. **Removal.** If it is necessary to replace a valve or valve spring in an emergency, notify higher authority so that repairs can be completed by a higher echelon.

- (1) REMOVE CYLINDER HEAD AND GASKET (par. 58).
- (2) REMOVE RIGHT FRONT WHEEL (par. 163).
- (3) REMOVE RIGHT FRONT FENDER SPLASH SHIELD (par. 178).

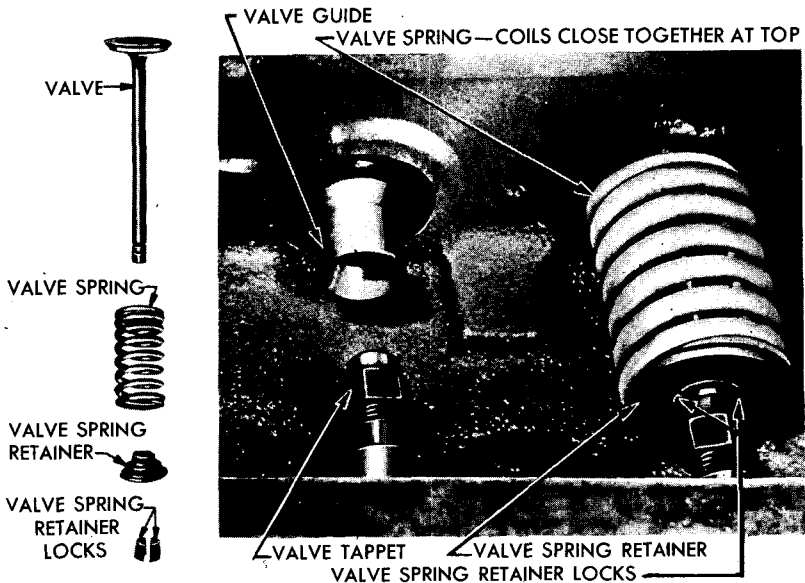

Figure 61—Valves and Springs

(4) REMOVE VALVE SPRINGS (fig. 62). If valve to be removed in front half of engine, remove fuel pump heat shield. If valve to be removed is in rear half of engine, remove ventilator outlet pipe and air cleaner. Remove the valve spring cover. If cover studs interfere with use of lifter on valve to be removed, lock two nuts together on the stud and remove the stud. Tuck small cloth in the oil return hole in the valve tappet compartment to prevent valve spring retainer locks falling into crankcase. If valve is not all the way down on its seat, turn engine until it is. Insert jaws of valve lifter between the lower end of the valve spring and the cylinder block, with the cupped jaw up. Hold the valve down and screw up valve lifter until valve spring is fully compressed. Remove the two valve retainer locks from the lower end of the valve stem. Lower and remove the valve lifter and lift the valve out. Raise the lower end

ENGINE—DESCRIPTION, MAINTENANCE, AND ADJUSTMENT IN VEHICLE

of the valve spring above the tappet screw and pull the spring retainer and the spring out between the tappet screw and the lower end of the valve stem guide.

b. Installation.

(1) **INSTALL VALVE SPRINGS** (figs. 61 and 62). Turn the crankshaft to bring the tappet down. Insert the valve spring and retainer into position with the coils which are closest toward cylinder head. Be sure the spring retainer is in position between the spring and the top of the spring seats in the recess in the cylinder block. Oil the valve stem and install the valve. Raise the valve spring and retainer with valve lifter and insert the split locks, large ends down, against

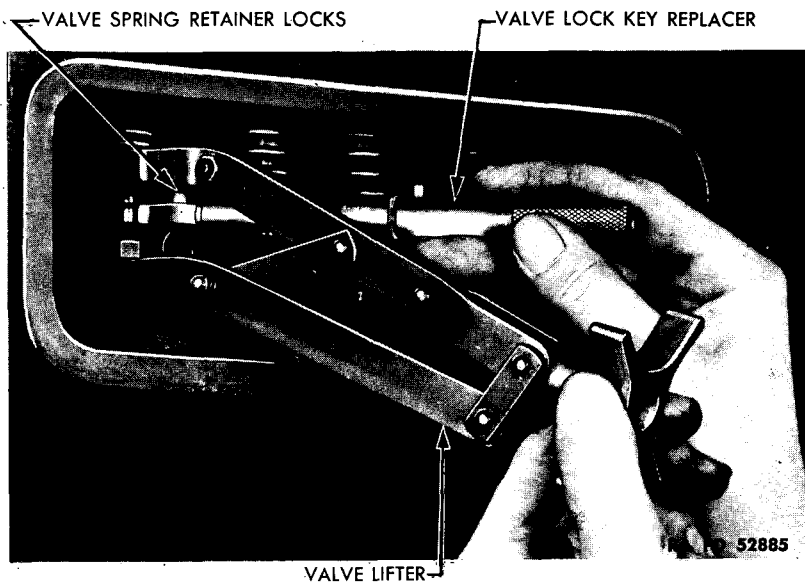

Figure 62—Installing Valve Spring Retainer Locks

the stops on the valve lock key replacer, and move the locks into position on the valve stem. Lower the valve spring until the valve spring retainer slides down over the top of the locks. Remove replacer from the valve stem. Lower the valve spring and remove the lifter. **CAUTION:** Remove the small cloth from the oil return hole.

(2) **ADJUST VALVE TAPPETS** (fig. 63). Run the engine at idling speed until it reaches normal temperature. Hold the tappet with wrench and adjust the screw until a 0.010-inch feeler gage will not go between the adjusting screw and valve stem, but a 0.012-inch feeler gage will not go between the adjusting screw and valve stem on both intake and exhaust valves.

3/4-TON 4 x 4 TRUCK (DODGE)

(3) **INSTALL VALVE COVERS.** Screw the valve spring cover stud into the cylinder block, if it was removed. Install the cover with a new gasket on the cover and the screw and stud to prevent oil leakage. Tighten the screw, install a plain washer over the gasket on the end stud, and tighten the nut. Install ventilator outlet pipe and air cleaner if removed. Install fuel pump heat shield if removed.

(4) **INSTALL RIGHT FRONT FENDER SPLASH SHIELD** (par. 178).

(5) **INSTALL RIGHT FRONT WHEEL** (par. 163).

(6) **INSTALL CYLINDER HEAD AND GASKET** (par. 58).

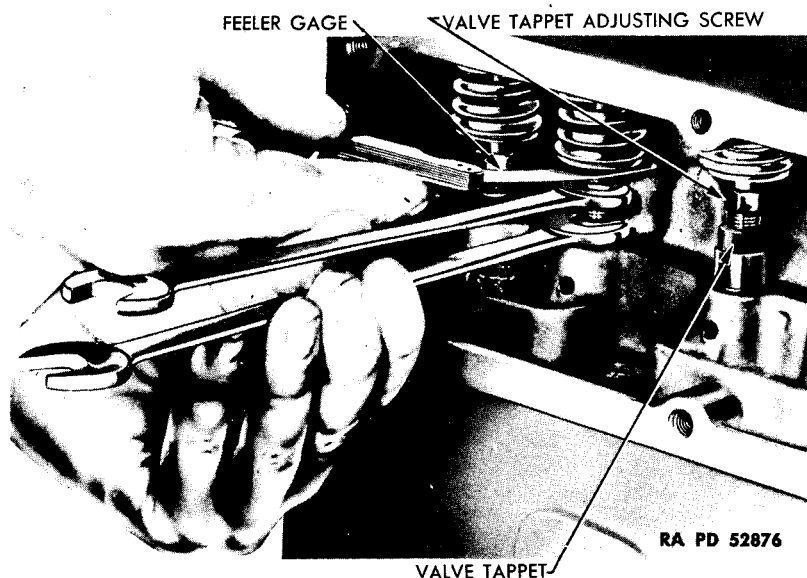

Figure 63—Adjusting Valve Tappet

58. CYLINDER HEAD GASKET.

a. Removal.

(1) **DRAIN COOLING SYSTEM** (par. 81).

(2) **REMOVE AIR CLEANER** (par. 69).

(3) **DISCONNECT ELECTRICAL CONNECTIONS.** Disconnect battery cable (par. 88). Lift spark plug wires off spark plugs. Remove cap screw located in right rear cylinder head cap screw and disconnect ground strap.

(4) **DISCONNECT WATER HOSE.** If vehicle is equipped with heater, release heater hose clamps at shut-off valve at rear of cylinder head and pull hose off connections on cylinder head. Loosen the two clamps and slide cylinder head outlet elbow to radiator water hose farther down outlet elbow. Disconnect bypass elbow from top of water pump.

ENGINE—DESCRIPTION, MAINTENANCE, AND ADJUSTMENT IN VEHICLE

(5) **DISCONNECT HORN, THERMOMETER BULB, AND CHOKE WIRE.** Remove the two nuts which hold horn to mounting bracket. Open clip which holds horn wire at oil filter bracket and move horn to one side. Open clip on cylinder head which holds thermometer wire, and remove thermometer bulb from cylinder head. Disconnect choke control wire and guide housing at the carburetor.

(6) **REMOVE CYLINDER HEAD.** Remove 20 cylinder head nuts and one cap screw. Lift off oil filter and bracket assembly, spark plug cable tube and bracket and clip for thermometer wire. Loosen breather bracket to breather pipe nut and slide bracket up pipe until it clears stud on cylinder block. Remove No. 5 spark plug and install lifting eye. Lift cylinder head from block and remove gasket.

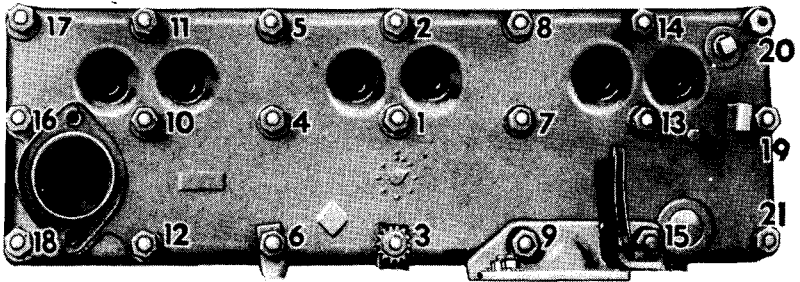

RA PD 312552

Figure 64—Cylinder Head Nut Tightening Sequence

b. **Cleaning and Inspection.** Loosen carbon from cylinder head, block, and tops of pistons with a stiff wire brush and carbon scraper. Thoroughly clean loose carbon from the cylinder walls, tops of the pistons, cylinder and block surfaces. Inspect for cracked or damaged surfaces.

c. **Installation (fig. 64).**

(1) **INSTALL GASKET AND CYLINDER HEAD.** Wipe the surfaces of the cylinder head and block with a clean cloth. Apply a thin coating of engine oil to the gasket surface of the cylinder block. Put the new gasket on the block and coat the top of the gasket with oil. Place the cylinder head in position on the block. Install spark plugs. Place filter and horn bracket assembly on studs 9 and 15, figure 64. Place toothed lock washer on stud 6, then put breather pipe bracket in place. Place toothed lock washer on stud 3, place spark plug cable tube and bracket on stud, and another toothed lock washer on bracket. Place thermometer wire clip on stud 19. Slide cylinder head outlet to radiator hose into place and tighten clamps. Install new gasket between bypass and water pump and attach bypass connection. Install the cylinder head nuts and cap screw. Tighten nuts and

3/4-TON 4 x 4 TRUCK (DODGE)

cap screw in the order shown in figure 64 with a torque wrench to 52.5 to 57.5 foot-pounds.

(2) **CONNECT GROUND STRAP, CHOKE WIRE, AND THERMOMETER BULB.** Place a toothed lock washer on each side of ground strap and attach with cap screw to head of cap screw in cylinder head. Connect choke guide housing in clamp. Push choke button all the way in and back off about $\frac{1}{16}$ inch. Then, with choke valve fully open, attach choke wire to choke valve at carburetor. Insert thermometer wire in clip and bend clip over. Install thermometer bulb in place and tighten.

(3) **ATTACH HEATER HOSE (IF SO EQUIPPED), HORN, AND SPARK PLUG CABLES.** Connect lower heater hose to valve at rear of cylinder block and tighten clamp. Then attach support clamp to stud at air cleaner support. Connect upper heater hose to take-off pipe at bypass and tighten clamp. Attach horn mounting bracket to filter bracket. Connect spark plug cables to spark plug terminals.

(4) **INSTALL AIR CLEANER AND CONNECT BATTERY TERMINAL.** Place air cleaner body on carburetor elbow and install screws and lock washers. Place oil reservoir in body. See that oil reservoir is clean and contains sufficient oil. Install cover and tighten wing nut. Connect cable to battery.

(5) **FILL COOLING SYSTEM.** Close radiator drain cock and fill cooling system with water. Run engine until it reaches normal temperature (approximately 20 minutes). Retighten cylinder head. If antifreeze solution is necessary in the radiator, drain the water and fill radiator with antifreeze solution. Make sure sufficient antifreeze solution is used to protect the cooling system at the lowest anticipated temperature (par. 81). Install radiator cap and tighten securely.

59. MANIFOLDS AND GASKETS.**a. Removal.**

(1) **DRAIN COOLING SYSTEM AND DISCONNECT HEATER HOSE (IF VEHICLE IS EQUIPPED WITH HEATER).** Open radiator drain cock and release radiator cap. If cooling solution contains antifreeze, drain in pan and save. Remove nut at top air cleaner bracket and disconnect lower heater hose support clamp. Disconnect heater hose at shut-off valve at rear of cylinder head and at bypass.

(2) **DISCONNECT FUEL LINE AND THROTTLE AND CHOKE WIRES.** Unscrew fuel pump to carburetor fuel line connection at carburetor. Remove hand throttle control wire and guide housing at carburetor. Disconnect hand choke control wire and guide housing at carburetor.

(3) **DISCONNECT WINDSHIELD WIPER HOSE AND BELL CRANK ROD.** Pull windshield wiper rubber hose from tube at manifold. Remove cotter pin from end of bell crank rod at bell crank and remove bell crank rod spring.

(4) **DISCONNECT EXHAUST PIPE AND LOOSEN FUEL PUMP HEAT SHIELD.** Remove the four nuts and two bolts which hold the exhaust pipe to the manifold. Remove the two nuts at muffler front support

ENGINE—DESCRIPTION, MAINTENANCE, AND ADJUSTMENT IN VEHICLE

to allow the exhaust pipe flange to clear manifold. Loosen wing nut which holds fuel pump heat shield to the pump.

(5) **REMOVE MANIFOLD ASSEMBLY.** Remove the 13 nuts and 8 washers which hold manifolds to cylinder block. Slide manifold assembly off studs and place upright on bench. Remove gaskets from cylinder block and/or manifolds. If gaskets only are being replaced, proceed with installation of parts removed (subpar. c (3) below).

(6) **REMOVE CARBURETOR FROM MANIFOLD.** Remove air cleaner support bracket cap screw at the manifold and remove bracket. Remove cotter pin which holds throttle control rod to bell crank and disconnect. Remove the two manifolds to carburetor stud nuts while lifting off carburetor and air cleaner assembly from manifold. Remove gaskets. Stand air cleaner and carburetor assembly in upright position to prevent oil spilling from air cleaner.

(7) **DISASSEMBLE EXHAUST AND INTAKE MANIFOLDS.** Remove the four cap screws on bottom side of exhaust manifold and pull manifolds apart. Remove gasket. Remove windshield wiper tube and connections from intake manifold. Remove throttle control wire and guide housing bracket nut, bell crank, throttle control lever and lever stud.

b. Installation.

(1) **ASSEMBLE INTAKE AND EXHAUST MANIFOLDS.** See that mating surfaces of intake and exhaust manifold are clean. Install new gasket and connect manifolds together with the four cap screws. Bring cap screws up snug but not tight. Install windshield wiper tube and fittings. Hold throttle control wire and guide housing bracket in position and install cap screw and lock washer closest to the dash; then install lever type stud and lock washer. Place bell crank in position on stud lever, then throttle control lever, spring washer, plain washer, and cotter pin.

(2) **INSTALL CARBURETOR AND AIR CLEANER ASSEMBLY.** Install new gasket between carburetor and manifold. Before lowering carburetor assembly flush with manifold, start nut on outside stud; then install both nuts. Attach manifold to air cleaner bracket with cap screw at manifold. Attach bell crank to carburetor throttle control rod and insert cotter pin.

(3) **INSTALL MANIFOLDS ON CYLINDER BLOCK.** Clean mating surfaces of manifold and cylinder block. Place new gaskets over manifold studs and slide manifolds into position over studs. Slide fuel pump heat shield into position. Install 13 nuts and 8 lock washers, as shown in figure 65, and tighten. Tighten the four cap screws that hold the intake and exhaust manifolds together. Tighten wing nut that holds fuel pump heat shield.

(4) **ATTACH EXHAUST PIPE TO MANIFOLD FLANGE.** Install new gasket between exhaust pipe and manifold flange. Then install bolts, nuts and lock nuts which connect these parts together. Install the two nuts that attach the front muffler bracket to the frame.

3/4-TON 4 x 4 TRUCK (DODGE)

(5) **CONNECT WINDSHIELD WIPER HOSE, CHOKE CONTROL, BELL CRANK ROD, THROTTLE CONTROL, AND FUEL LINE.** Slide windshield wiper flexible hose on manifold tube. Connect hand choke control guide housing in clamp, push choke button all the way in and back off about $\frac{1}{16}$ inch. With choke valve fully open, attach choke wire to choke valve, at carburetor. Put spring on bell crank rod, insert rod in bell crank and install cotter pin. Connect hand throttle control guide housing in clamp. With throttle control button on dash pushed all the way in, hold throttle control lever back against its stop, insert wire in hole and tighten. Connect fuel pump to carburetor fuel line at carburetor.

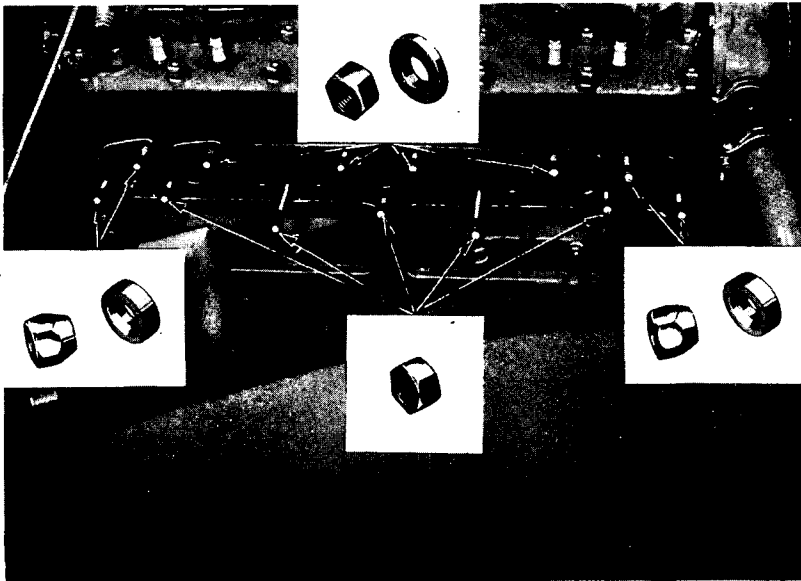

RA PD 52722

Figure 65—Manifold Stud Nut and Washer Locations

(6) **ATTACH HEATER HOSE (IF SO EQUIPPED).** Connect lower heater hose to shut-off valve at rear of cylinder head and tighten clamp. Attach hose support clamp to stud at air cleaner elbow and install plain washer, lock washer, and stud nut. Connect upper heater hose to take-off pipe at bypass and tighten clamp.

(7) **FILL COOLING SYSTEM.** Close radiator drain cock and fill cooling system. If antifreeze solution was drained out, use it again, but make sure sufficient antifreeze solution is used to protect cooling system at the lowest anticipated temperature (par. 81). Install radiator cap and tighten securely.

ENGINE—DESCRIPTION, MAINTENANCE, AND ADJUSTMENT IN VEHICLE

60. OIL PAN.

a. **Removal.** Remove drain plug and drain engine oil in pan. As soon as the oil is drained, install drain plug and tighten securely. Remove oil level indicator. Remove the oil pan attaching cap screws. Remove center screws last and lower pan. Pull out cotter pin and remove oil strainer (fig. 66) from oil pump suction pipe. Open the lips on the strainer plate.

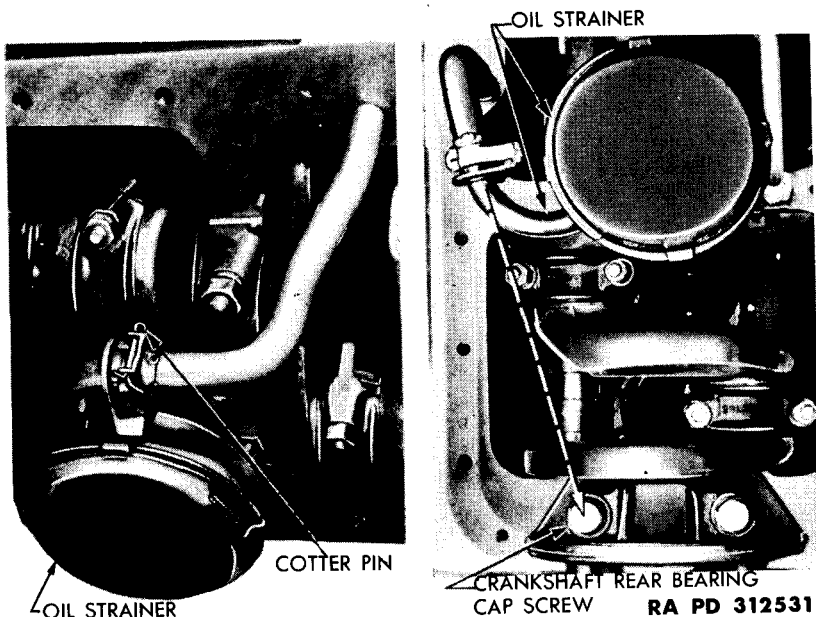

Figure 66—Floating Oil Strainer

b. **Cleaning.** Scrape all traces of the old gaskets from the oil pan. Clean and wash strainer and oil pan thoroughly with dry-cleaning solvent.

c. Installation.

(1) **INSTALL OIL STRAINER** (fig. 66). Position plate on strainer and close the plate lips. Then connect strainer to the oil pump suction pipe and insert new cotter pin. Make sure the strainer is positioned so that its movement is not restricted by the oil pan baffles. Aline strainer assembly so that pipe is in relation to crankshaft rear bearing cap screw, as shown in figure 66.

(2) **INSTALL OIL PAN GASKETS AND OIL PAN** (fig. 67). Install new gaskets on the pan. Install the end gaskets first. They will protrude $\frac{1}{8}$ inch to $\frac{1}{4}$ inch above the oil pan. Do not cut off the ends of the gaskets as they will compress into place when the oil pan screws are tightened. Place side gaskets over the ends of end gaskets. Hold

3/4-TON 4 x 4 TRUCK (DODGE)

the side gaskets in place with heavy cup grease or tie in place with light string through several bolt holes. Lift the pan into position, being careful that the pan gaskets remain in position and that the felt dust seal at the clutch housing is not interfered with. Install and tighten the attaching cap screws with lock washers. Remove the breather pipe air cleaner and fill the crankcase with engine oil (par. 24). Install oil level indicator.

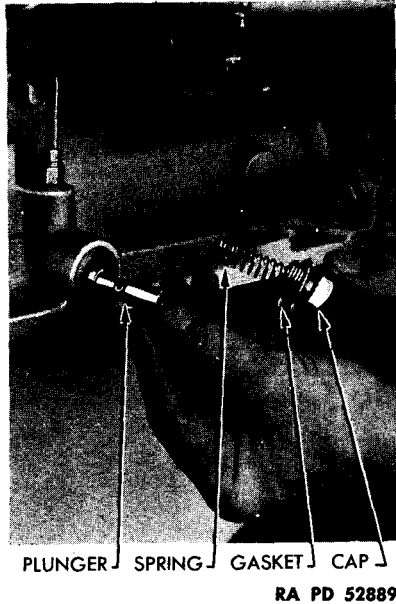
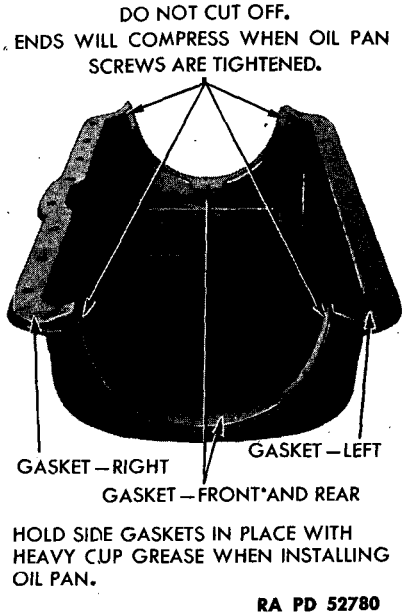

Figure 67—Oil Pan Gaskets

Figure 68—Oil Pressure Relief Valve

61. OIL PRESSURE RELIEF VALVE AND OIL PUMP.

a. **Removal of Relief Valve** (fig. 68). The oil pressure relief valve is located directly below the oil filter at juncture of oil pan and cylinder block. Remove oil pressure relief valve cap, gasket, and plunger spring. Insert sharp end of small prick punch into opening in plunger and remove.

b. **Cleaning and Inspection.** Clean and inspect plunger spring and plunger seat for proper seating.

c. **Installation of Relief Valve.** Install plunger, flat end first and place plunger spring in position. Then install new gasket and original cap.

d. **Removal of Oil Pump.** Remove the two cap screws which attach the engine dust pan to frame side member. Remove the two nuts from the bolts which hold the dust pan and front spring torque

**ENGINE—DESCRIPTION, MAINTENANCE, AND ADJUSTMENT
IN VEHICLE**

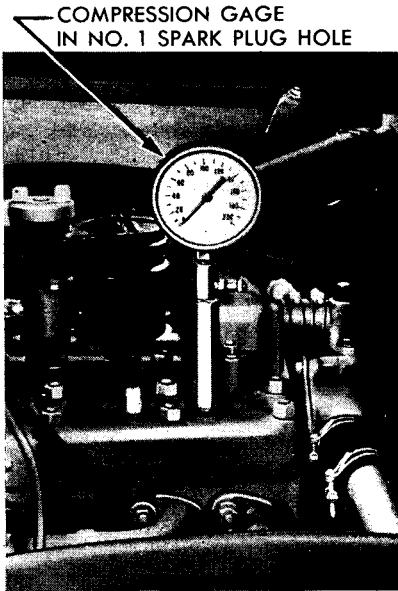

1—LOCATING COMPRESSION STROKE IN NO. 1 CYLINDER

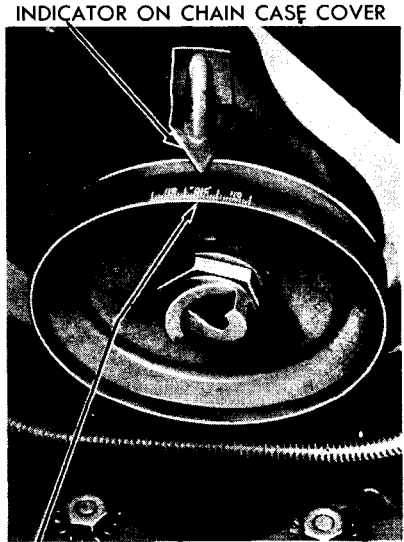

2—LOCATING TIMING MARK ON FAN PULLEY

1—“DC” MARKING ON FAN PULLEY—LOWER
2—DISTRIBUTOR LOCK PLATE

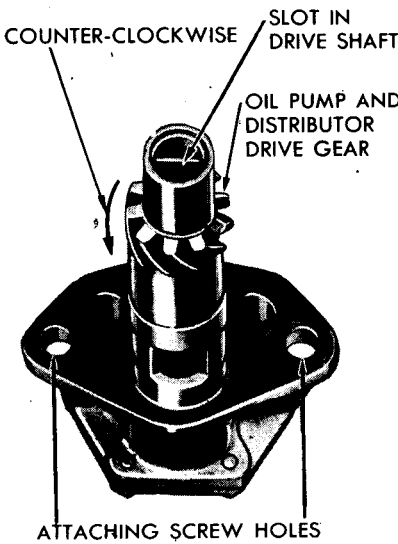

3—LINING UP SLOT IN OIL PUMP SHAFT

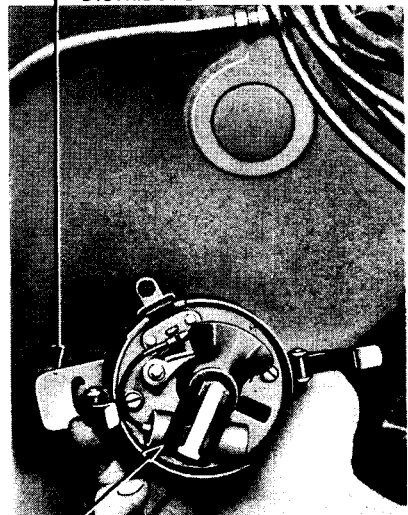

4—INSTALLING DISTRIBUTOR AFTER INSTALLING OIL PUMP
RA PD 312553

Figure 69—Installation of Oil Pump

3/4-TON 4 x 4 TRUCK (DODGE)

arrester to frame side member. Lower dust pan sufficiently to permit removal of oil pump. Remove the two cap screws from the oil pump mounting flange and remove pump.

e. Installation of Oil Pump (fig. 69).

(1) **SET CRANKSHAFT IN PROPER POSITION.** Remove distributor cap and disconnect the primary lead wire at the distributor. Remove the distributor lock plate screw and lift out the distributor. Remove No. 1 spark plug. Crank engine by hand and check for compression on No. 1 cylinder by holding thumb tightly over spark plug hole or by installing a compression gage in hole. When compression is felt by thumb or shows on gage, turn crank until indicator points to "DC" on crankshaft fan pulley (fig. 69).

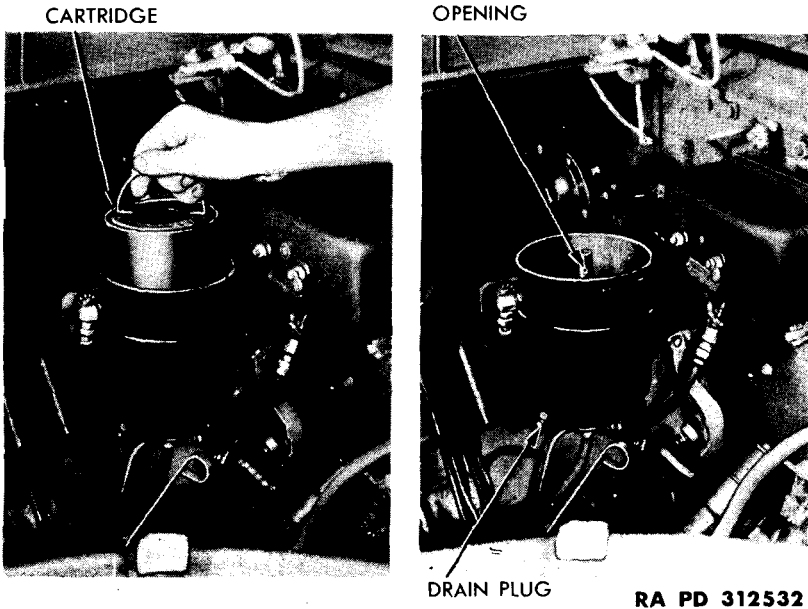

Figure 70—Oil Filter

(2) **INSTALL OIL PUMP.** Turn pump drive shaft until the slot in end of drive shaft lines up with the bolt holes in mounting flange. Then turn drive shaft gear one tooth counterclockwise. Install pump in cylinder block, being careful not to turn pump drive gear.

(3) **INSTALL DISTRIBUTOR.** Install distributor with the lock plate in position. Turn distributor rotor so that it points to seven o'clock. Rotate the rotor a little one way or the other to allow the distributor shaft to mesh with the oil pump shaft. Install the distributor lock plate screw. Attach distributor primary lead wire to distributor filter and install distributor cap. Install spark plug. Adjust ignition timing (par. 99).

**ENGINE—DESCRIPTION, MAINTENANCE, AND ADJUSTMENT
IN VEHICLE**

(4) **INSTALL RIGHT ENGINE DUST PAN.** Install two cap screws and lock washer in frame side member. Hold the front spring torque arrester in position, install the two toothed lock washers and nuts on the bolts and tighten.

62. OIL FILTER.

a. **Removal of Cartridge (fig. 70).** Unscrew the cover retaining nut, remove cover and lift out cartridge.

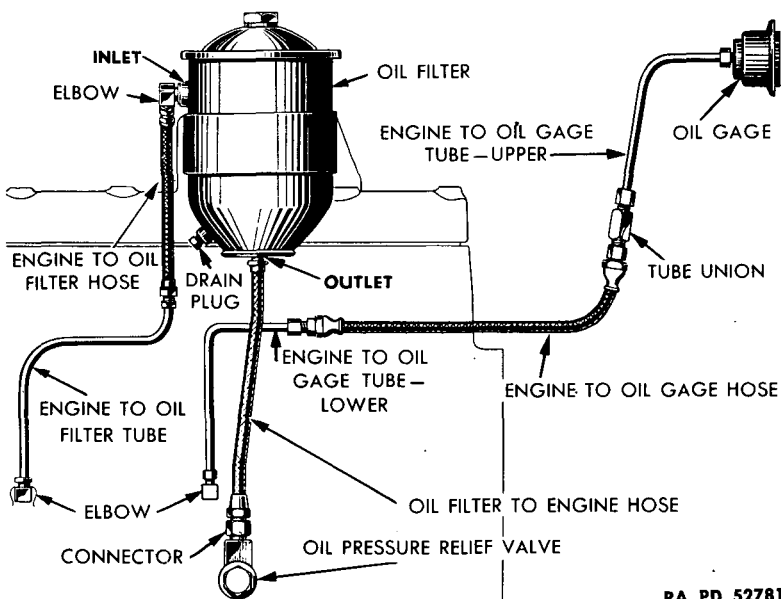

RA PD 52781

Figure 71—Oil Filter and Oil Gage Hose and Tubing

b. **Cleaning.** Remove drain plug from bottom of oil filter body and clean inside of filter body with rag wet with dry-cleaning solvent. Be sure oil outlet hole in filter outlet tube is open (fig. 70), and replace drain plug.

c. **Installation of Cartridge.** Install new cartridge in filter body. Place cover gasket and cover in place, and tighten retaining nut firmly to prevent leakage.

d. **Removal of Oil Filter Assembly (fig. 71).** Disconnect oil filter inlet hose at top of filter body. Disconnect oil filter outlet hose at crankcase. Remove two front bolts which attach the oil filter clamp to the oil filter bracket. Loosen oil filter clamp bolt until filter body is free to lift out. Remove outlet hose from filter body. Screw lower end of outlet tube into inlet fitting and tighten to avoid damage to inlet fitting and remove fitting.

3/4-TON 4 x 4 TRUCK (DODGE)

e. **Installation of Oil Filter Assembly** (fig. 71). Install inlet fitting in top of filter body and remove outlet hose from inlet fitting. Then install outlet hose to bottom of filter body. Place filter assembly in bracket with inlet fitting facing front of vehicle. Tighten oil filter clamp bolt. Insert clamp to bracket attaching bolts with toothed lock washer under head of each bolt. Install another toothed lock washer under nuts and tighten. Attach oil filter inlet hose to fitting at top of filter body. Attach oil filter outlet hose to fitting in crankcase.

63. OIL TUBES (EXTERNAL).

a. Removal.

(1) **REMOVE OIL FILTER INLET TUBE.** Disconnect oil inlet tube from inlet hose. Remove cylinder head stud nut. Hold breather pipe bracket and remove filler pipe by tapping up on the bracket. On later models, the tube is flanged at the bottom and held in place with two cap screws which must be removed. Disconnect the inlet tube at cylinder block.

(2) **REMOVE OIL GAGE LOWER TUBE.** Remove oil level indicator. Disconnect oil tube at crankcase. Disconnect the oil tube from oil gage hose.

(3) **REMOVE OIL GAGE UPPER TUBE.** Disconnect tube at the gage hose. Remove the self-tapping cap screws which hold the two upper tube brackets to dash. Disconnect the oil tube at oil gage. Pull tube through the dash.

b. Repair.

(1) **CUT NEW TUBE WITH TUBE CUTTER.** Measure tube for length desired and cut with tube cutter.

OIL TUBE LENGTHS

Oil gage lower tube	8½ in.
Oil filter inlet tube	12 in.
Oil gage upper tube (except Ambulance and Carryall)	26¾ in.
Oil gage upper tube (Ambulance and Carryall)	34 in.

(2) **BEND TUBING WITH TUBING BENDER.** Use removed tube as a template or guide and form the tube to the same shape as the tube removed.

(3) **FLARE ENDS OF TUBE WITH FLARING TOOL.** Slide the attaching nuts on each end of the oil tube and flare each end of the tube with flaring tool.

c. Installation.

(1) **INSTALL OIL FILTER INLET TUBE.** Connect inlet tube at cylinder block. Hold breather pipe and bracket in position with bracket over cylinder head stud, and tap breather pipe into crankcase, if it is the "slip-in" type. Install "slip-in" type pipes with offset to the rear on vehicles with 6-volt generator and with offset to front on vehicles with 12-volt generator. Later models are equipped with breather pipes which are flanged at the bottom. Two types are used: for vehicles with 6-volt generator, install with offset to the rear; for

**ENGINE—DESCRIPTION, MAINTENANCE, AND ADJUSTMENT
IN VEHICLE**

vehicles with 12-volt generator, install with offset to front. Install cylinder head stud nut and tighten to 52.5 to 57.5 foot-pounds with torque wrench. Connect oil inlet tube to inlet hose.

(2) **INSTALL OIL GAGE UPPER TUBE.** Push oil tube through the dash and connect at oil gage. Install the two brackets which hold the upper tube to the dash with the self-tapping cap screws, and toothed lock washer between each bracket and the dash. Connect tube to the gage hose.

(3) **INSTALL OIL GAGE LOWER TUBE.** Connect oil tube at crank-case. Then connect the oil tube to the oil gage hose. Place oil level indicator in position.

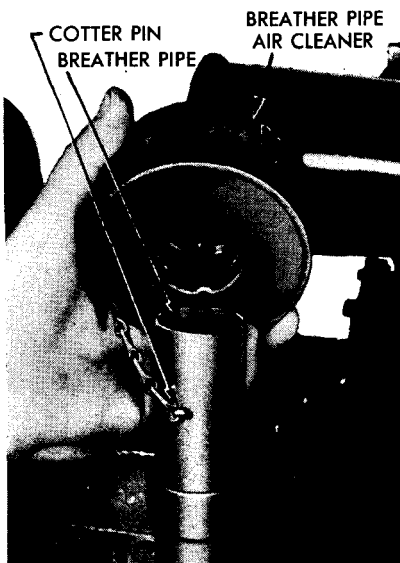

OILED MESH TYPE

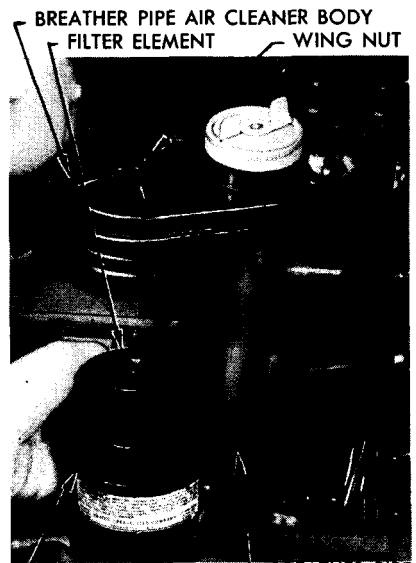

RESERVOIR CUP BREATHER PIPE
OIL BATH TYPE

RA PD 318326

Figure 72—Breather Pipe Air Cleaners

64. BREATHER PIPE AIR CLEANER.

a. **Cleaning Procedure (Oiled Mesh Type)** (fig. 72). Lift the air cleaner off the breather pipe and remove cotter pin from the attaching chain. Wash the filter element in dry-cleaning solvent and dry. Dip the element in fresh engine oil and drain off the surplus oil. Connect the attaching chain and install the cleaner on the breather pipe.

b. **Cleaning Procedure (Oil Bath Type)** (fig. 72). Hold the oil cup and turn the wing nut on the cleaner counterclockwise to release the oil reservoir cup and the filter element. Wash the filter element

3/4-TON 4 x 4 TRUCK (DODGE)

in dry-cleaning solvent and dry. Fill the oil reservoir cup to the level mark with fresh engine oil. Install the filter element over the stud in oil reservoir cup. Insert the stud into the cleaner body, install the wing nut, and tighten securely.

65. CRANKCASE VENTILATOR.

a. **Cleaning Procedure (Outlet Pipe Type with Air Cleaner)** (fig. 73). Remove the outlet pipe bracket to crankcase cap screw. Remove the air cleaner to crankcase cap screw. Lift the filter element from the filter body. Wash the element and filter body in dry-cleaning solvent. Dip the element in fresh engine oil and drain off surplus oil.

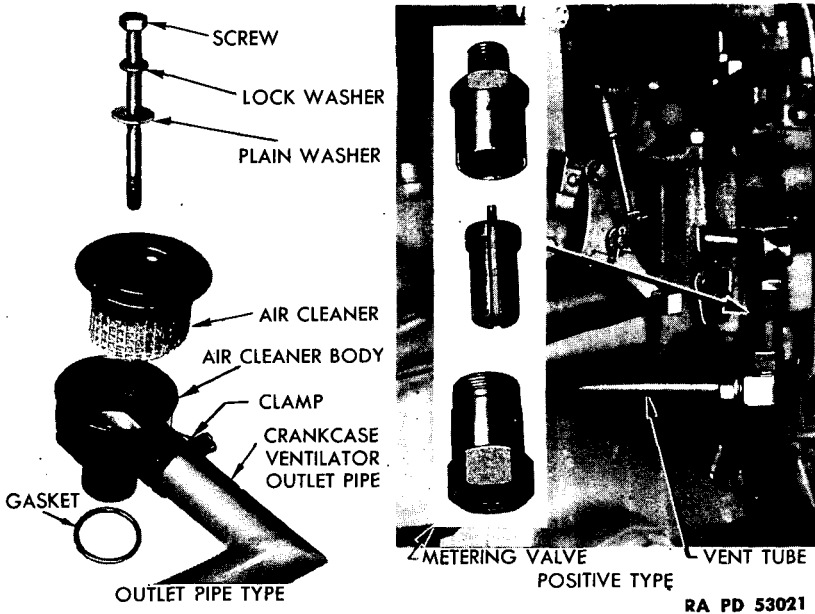

Figure 73—Crankcase Ventilators

Place the filter element into the cleaner body. Insert the screw through the cleaner with a plain washer next to the element and a lock washer under the screwhead. Install the oil cleaner-to-crankcase cap screw. Install the outlet pipe bracket-to-cylinder head cap screw.

b. **Cleaning Procedure (Positive Type Connected to Intake Manifold)** (fig. 73).

(1) **REMOVE METERING VALVE.** Remove the cap screw and plain washer which attaches the tube to the crankcase. Disconnect the tube from the metering valve. Screw the metering valve assembly from the manifold connection and remove the connection from the manifold.

**ENGINE—DESCRIPTION, MAINTENANCE, AND ADJUSTMENT
IN VEHICLE**

(2) **CLEAN METERING VALVE AND VENT TUBE.** Clamp the lower end of the metering valve in a vise and screw off the upper part of the body. Wash the valve, vent tube, and the manifold connection, with dry-cleaning solvent and remove any carbon or gum. Assemble the metering valve in the valve body with the pintle end up and screw the upper part of the valve body into place.

(3) **INSTALL METERING VALVE.** Screw the manifold connection into the manifold. Install the metering valve with the arrow up. Place the vent tube connection in position at the rear of the crankcase and install the attaching cap screw with plain washer under the head of the cap screw. Connect the forward end of the vent tube to the metering valve.

3/4-TON 4 x 4 TRUCK (DODGE)

Section XV

ENGINE REMOVAL AND INSTALLATION

	Paragraph
Removal	66
Installation	67

66. REMOVAL.

- a. Remove Hood (par. 178).
- b. Drain Cooling System (par. 81).
- c. Remove Fenders, Radiator Shell, and Core Assembly.

(1) **DISCONNECT RADIATOR.** Disconnect the tie rods at the radiator shell. Loosen the front tie rod nut at the cowl bracket. Hold the rear nut and turn the tie rod out of the nut. Loosen the upper radiator hose clamp at the cylinder head water outlet elbow and the lower radiator hose clamp at the water pump. Leave the hose attached to the radiator core. Remove radiator drain cock, if vehicle is equipped with a winch.

(2) **DISCONNECT OR REMOVE BATTERY.** Remove battery if vehicle is equipped with 6-volt electrical system (par. 88). Disconnect cable from battery if vehicle is equipped with 12-volt electrical system.

(3) **DISCONNECT GENERATOR TO REGULATOR WIRING AT GENERATOR.** Disconnect the wiring clip from the generator. Disconnect the two wires of the generator to regulator wiring assembly at the regulator and also remove the wiring to regulator clip screw. Leave the generator to regulator wiring assembly attached to the left front fender splash shield.

(4) **DISCONNECT LIGHT WIRES.** Pull the blackout light wires from their sockets on each side at the connections near the terminal blocks on the front cross member. Remove the nuts attaching the light wires to the terminal blocks. Remove the wires from the clips on the cross member.

(5) **DISCONNECT SPLASH SHIELD GROUND STRAP AND BATTERY TRAY.** Disconnect the ground strap at the front of the fender splash shield. Remove the nut from the bolt attaching the battery tray to fender splash shield ground strap at the splash shield. If vehicle is equipped with 6-volt electrical system, remove the 3 bolts that attach the battery tray to the frame.

(6) **DISCONNECT SPLASH SHIELDS AND FENDERS (fig. 74).** Disconnect the left and right front fender splash shield at frame rear brackets. Disconnect the front fender rear supports at the front fender rear support brackets. Disconnect the radiator shell assembly at the frame front cross member.

(7) **VEHICLES EQUIPPED WITH FAN SHROUD.** Remove fan and pulley (par. 85).

(8) **REMOVE ASSEMBLY (fig. 74).** Attach chain fall to the radiator, shell, and fender assembly, and lift it off the vehicle. Have a helper

ENGINE REMOVAL AND INSTALLATION

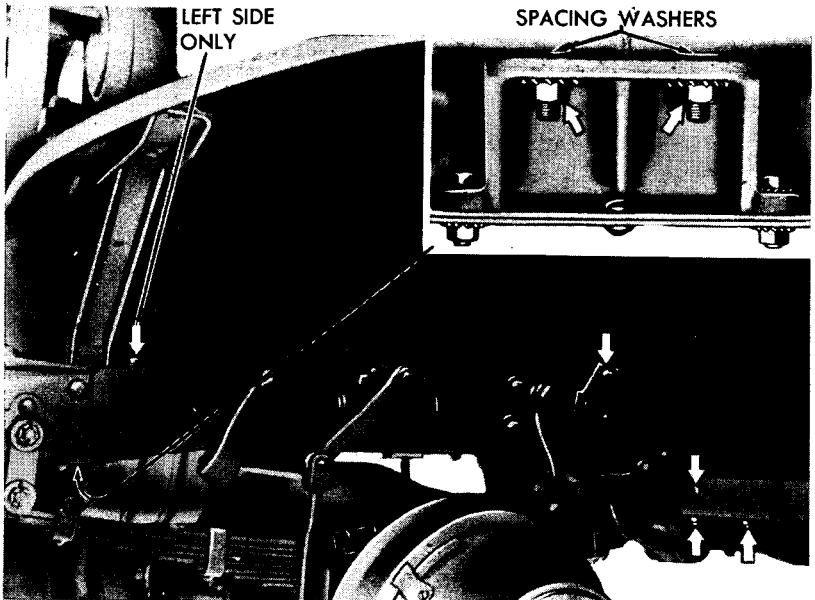
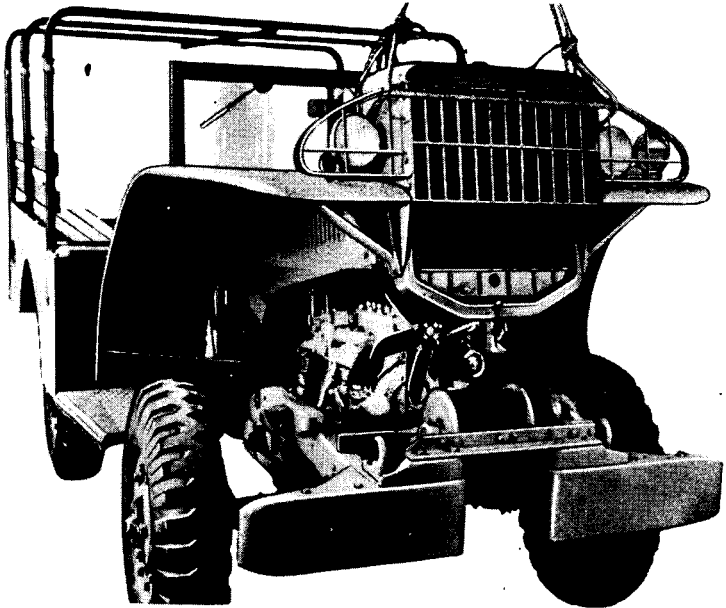

RA PD 312533

Figure 74—Removing Fenders and Radiator

3/4-TON 4 x 4 TRUCK (DODGE)

at the rear of each front fender to assist in guiding the assembly while it is being removed. If there are any spacing washers between the radiator support and the frame cross member, be sure they are not lost as they will be needed to install the radiator in the same relative position for proper hood alinement.

d. Remove Transmission Assembly (par. 133). The engine assembly may be removed with transmission attached after disconnecting propeller shaft, removing transmission gearshift lever housing, hand brake lever, transfer case lever and winch shifter lever (if so equipped).

e. Disconnect Distributor Wiring. Disconnect the coil to distributor filter wire at the filter. Pull the high tension cable out of the distributor cap.

f. Disconnect Oil Gage Tube and Filter Flexible Hoses. Disconnect the oil gage tube at the flexible hose connection. Disconnect the oil filter inlet flexible hose at the filter and outlet flexible hose at the crankcase.

g. Remove Horn Assembly (par. 120).

h. Disconnect Thermometer, Cranking Motor Pedal, and Wiring. Spread the thermometer wire clip to release the wire at cylinder head stud. Unscrew the gland nut and disconnect the thermometer wire at the cylinder head. Move the wire out of the way to prevent damage when the engine is removed. Pry off the clip or retainer which holds the cranking motor pedal rod pin in place on the cranking motor shift lever yoke and remove pin. Remove the wires from the cranking motor switch. Disconnect the ground strap at the rear of the cylinder head.

i. Disconnect Flexible Hose at Fuel Pump. Hold the elbow and unscrew the attaching nut.

j. Remove Carburetor Air Cleaner (par. 69).

k. Disconnect Throttle and Choke and Windshield Wiper. Disconnect the throttle wire and guide housing at the throttle bell crank which is mounted on the manifold bracket. Loosen the screws and disconnect the choke wire and guide housing at the carburetor. Disconnect the windshield wiper flexible hose at the manifold vacuum tube.

l. Remove Exhaust Pipe and Right Engine Dust Pan. Disconnect the exhaust pipe at the manifold. Remove the torque arrester from the underside of the frame side member. Pry open the fender lamp cable clip at the screw attaching the pan to the front cross member and move the cable out of the way, then remove the screw. Remove the two front pan screws and remove dust pan.

m. Disconnect Engine Ground Straps. Disconnect the ground straps between the clutch housing and the right and left sides of the frame. The strap on the left is attached with one of the screws holding the clutch pedal bracket. The ground strap on the right side is attached to the clutch housing.

ENGINE REMOVAL AND INSTALLATION

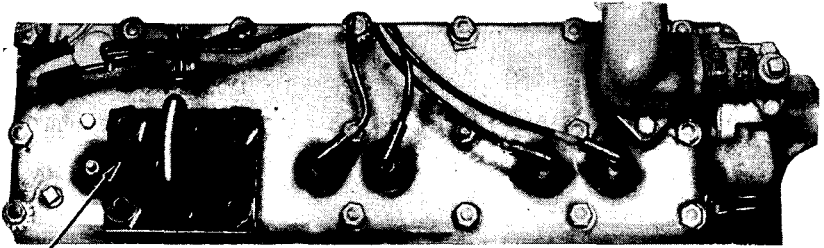

LIFTING PLATE IN POSITION FOR REMOVING OR
INSTALLING ENGINE WITH TRANSMISSION

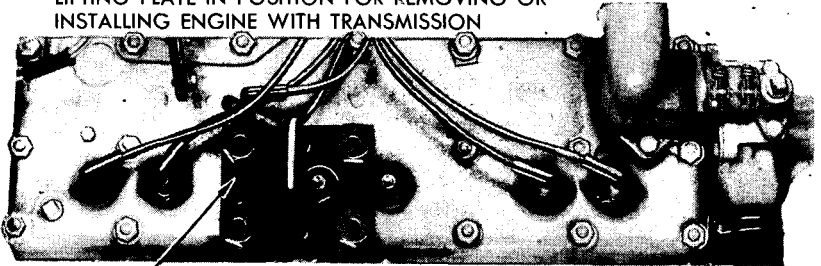

LIFTING PLATE IN POSITION FOR REMOVING OR
INSTALLING ENGINE LESS TRANSMISSION

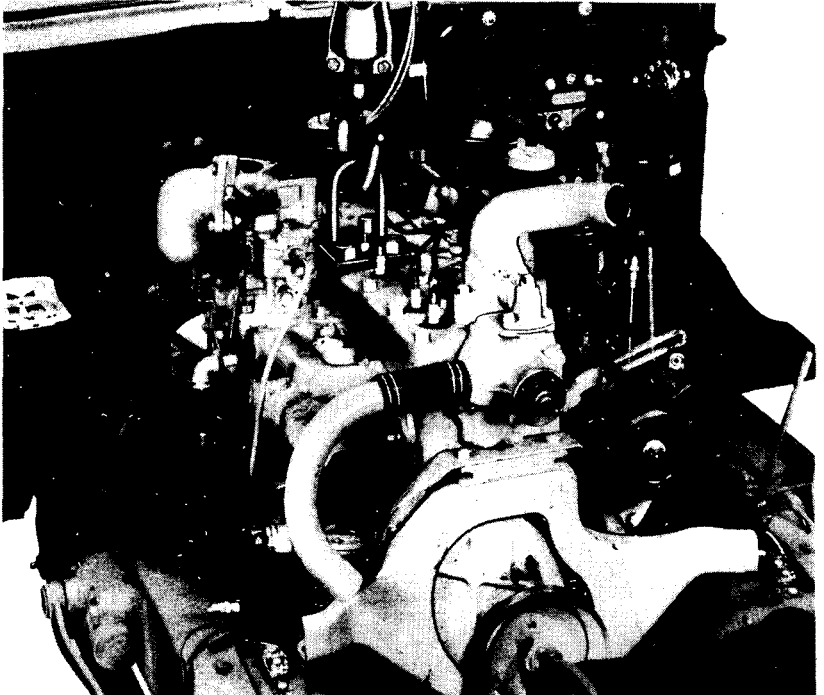

RA PD 312554

Figure 75—Removing Engine

3/4-TON 4 x 4 TRUCK (DODGE)

n. **Remove Clutch and Brake Pedal Bracket Assemblies.** Remove the cotter pin from the clutch operating rod pin. Remove the remaining screws which connect the clutch pedal and bracket assembly to the clutch housing. Disconnect the clutch pedal pull-back spring from the frame bracket with brake spring pliers and remove the assembly from the vehicle. Remove the rear end of the brake pull-back spring from the pull-back spring bracket with brake spring pliers, and unhook the spring from the brake pedal pull-back spring extension. Remove the cotter pin from the push rod end pin and remove the pin. Remove the bolts that attach the brake pedal and bracket assembly to the frame and remove the assembly from the vehicle.

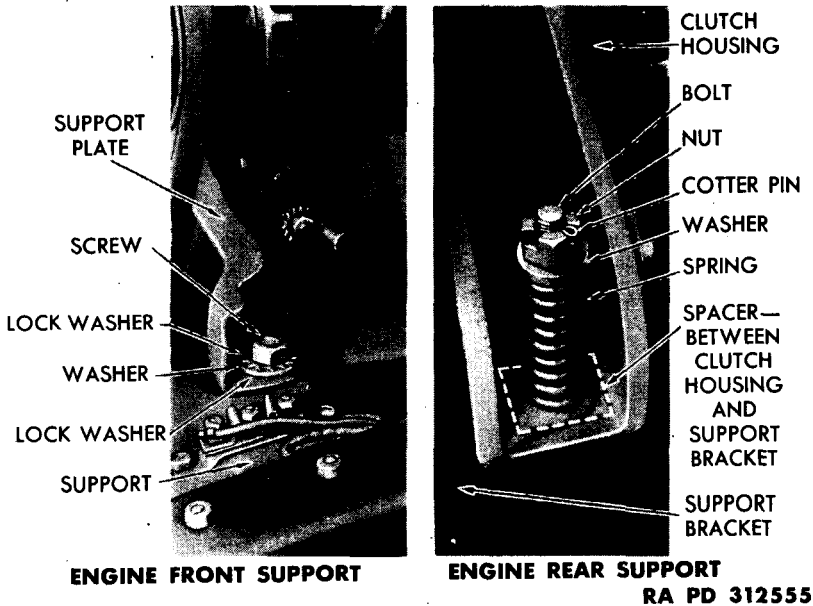

Figure 76—Engine Supports

o. **Lift Engine From Frame** (figs. 75 and 76). Install engine lifting fixture. Attach chain fall to fixture and relieve the weight of the engine from the engine support bolts. Remove the cotter pin from the rear engine support bolts. Hold the support bolt nuts and remove the bolt. Remove the front engine support cap screws. Lift the engine out of the vehicle. Exercise care in lifting the engine to prevent damaging the attaching parts and accessories.

67. INSTALLATION.

a. **Install Engine in Chassis** (figs. 75 and 76). Place the two small fabric pads or spacers on the rear motor support frame

ENGINE REMOVAL AND INSTALLATION

brackets. Install engine lifting fixture. Attach chain fall to fixture. Lift the engine and move the assembly into place so that the rear engine support bolts as well as the front engine support screws can be inserted. Guide the accelerator rod into the body opening as the engine is moved into the frame. Be careful that none of the parts are damaged or broken as a few minutes of careful handling will save a great deal of trouble.

b. **Install Mounting Bolts** (fig. 76). Insert the rear engine support bolts through the frame brackets and engine support from underneath and install the rear support bolt springs, washers, and nuts. Hold the bolts and tighten the castellated nuts sufficiently so that the cotter pins can be installed. Install the front engine support screws with a toothed lock washer, a plain washer, and another toothed lock washer and tighten.

c. **Install Brake Pedal and Bracket Assembly**. Place the brake pedal bracket on the frame side member. Install toothed lock washer under each bolt head and one under each nut. Install the master cylinder push rod on the brake pedal lever and install the push rod end pin and cotter pin. Attach the brake pull-back spring to the brake pull-back spring extension and connect it to the brake pedal pull-back spring bracket with brake spring pliers. *NOTE: Due to a slight change that may take place in the position of the engine mountings when installing an engine assembly, it may be necessary to adjust the brake pedal free travel (par. 151) and the clutch pedal free play (par. 130).*

d. **Install Clutch Pedal and Bracket**. Position the clutch pedal and bracket assembly on the rear motor support. Insert one of the short screws with lock washer in the upper right hole, the one long screw with lock washer in the lower left hole and another short screw with lock washer in the lower right hole. Tighten the three screws. The fourth screw attaches the ground strap. Place toothed lock washer on each side of the ground strap and tighten screw. Connect the clutch pedal pull-back spring to the frame bracket with brake spring pliers. Connect the clutch operating rod. Insert the operating rod pin in the yoke and install the cotter pin. Connect the engine to frame ground strap to the right side of the clutch housing. Assemble a toothed lock washer on each side of the strap and install the screw.

e. **Install Right Engine Dust Pan**. Attach the dust pan to the frame side member at the front with two screws and lock washers. Then attach the pan at the front cross member and at the same time fasten the light wire clip. Move the light wire under the clip and bend the clip over the wire. Install the torque arrester and tighten the two front dust pan screws.

f. **Install Exhaust Pipe**. Lift the exhaust pipe into position with a new exhaust pipe flange gasket and install the lock washers, nuts, and lock nuts.

g. **Connect Throttle, Choke, Windshield Wiper, and Cylinder Head Ground Strap**. Insert the choke control wire in the choke air shutter lever swivel and the guide housing in the clip on the bracket

3/4-TON 4 x 4 TRUCK (DODGE)

so that the housing is flush with the forward end of the clip. Tighten the clip. Connect the throttle control wire and guide housing to the manifold and tighten the clip screw. Insert the throttle control wire in the block on the throttle control bell crank. See that the throttle button on the dash is pushed in completely and tighten the set screw on the block. Connect the windshield wiper flexible hose to the manifold vacuum tube. Connect dash to cylinder head ground strap to cylinder head screw with toothed lock washers on top and bottom of strap.

h. Install Carburetor Air Cleaner (par. 69).

i. Connect Flexible Hose at Fuel Pump. Hold the elbow with wrench and connect the attaching nut.

j. Connect Thermometer, Cranking Motor Pedal and Wiring at Cranking Motor Switch. Place the ammeter and cranking motor filter wires on the cranking motor switch terminal and tighten the terminal nut. Position the cranking motor pedal rod in the cranking motor shift lever yoke. Insert the pin and install the pin retainer. Slide the thermometer bulb into the cylinder head fitting and tighten nut. Attach the tube to the clip at cylinder head stud and close the clip.

k. Install Horn Assembly (par. 120).

l. Connect Oil Gage and Distributor Wires. Connect the oil gage tube at the flexible hose connection. Connect the oil filter inlet flexible hose at the filter and the outlet flexible hose at the crankcase. Connect the coil to distributor filter wire at the filter. Push the high tension cable into the distributor cap.

m. Install Transmission Assembly (par. 133).

n. Install Fenders, Radiator Shell and Core Assembly.

(1) **LOWER ASSEMBLY INTO POSITION (fig. 74).** If there were any spacing washers between the radiator support and the frame cross member when the fenders, radiator shell, and core assembly were removed, slip them into place as the assembly is being lowered. Attach chain fall to the assembly and lower it into position. Have a helper at the rear of each front fender to assist in guiding the assembly into place.

(2) **CONNECT RADIATOR, FENDERS, AND SPLASH SHIELDS.** Install toothed lock washers and start the nuts on the studs which attach the radiator shell assembly to the frame front cross member, but do not tighten until after the hood has been installed. Install the six screws with toothed lock washers that fasten the front fender rear supports to the front fender rear support brackets. Install the screws with toothed lock washers that attach the left and right fender splash shields to the front fender rear support.

(3) **CONNECT BATTERY TRAY AND GROUND STRAPS.** If the vehicle is equipped with 6-volt electrical system, install the three bolts that hold the battery tray to the frame, and at the same time slip the fuel tube clip on the center bolt with a toothed lock washer under the bolt head and one under the nut. Attach the battery tray to

ENGINE REMOVAL AND INSTALLATION

fender splash shield ground strap at the splash shield with a toothed lock washer under the bolt head and one behind the nut. Connect the ground strap with the screw and toothed lock washers to the frame side member at the front of the left fender splash shield.

(4) **CONNECT LIGHT WIRES.** Push the blackout parking lamp wires into their sockets on each side of the connections near the terminal blocks on the front cross member. Place the light wires on the terminal block. Connect each wire to the terminal that carries the same color wire at block on the frame. Place the wire in the clip to hold the wire to the cross member and close the clip.

(5) **CONNECT GENERATOR TO REGULATOR WIRING AT GENERATOR.** Connect the wiring clip at the generator. Connect the two wires of the generator to regulator assembly at the regulator. Install the small green wire to the terminal marked "GEN" and the larger red wire to the terminal marked "ARM." Install wiring to regulator clip screw.

(6) **CONNECT OR INSTALL BATTERY.** Connect battery cable if vehicle is equipped with 12-volt electrical system. Install battery if vehicle is equipped with 6-volt electrical system (par. 88).

(7) **CONNECT WATER HOSE.** Tighten the upper radiator hose clamp at the cylinder head water outlet elbow and the lower radiator hose clamp at the water pump. Install radiator drain cock, if vehicle is equipped with a winch.

(8) **VEHICLES EQUIPPED WITH FAN SHROUD.** Install fan and pulley (par. 85). Adjust fan belt (par. 82).

o. Install Hood (par. 178).

p. Install Radiator Tie Rods. Attach the front end of the tie rods to the radiator shell and install the radiator shell bolts and nuts with a toothed lock washer under each bolt head and one behind each nut. Tighten nuts. Place the nuts with toothed lock washers on the rear end of the tie rods at the dash bracket. On vehicles not equipped with a fan shroud, adjust the radiator tie rods so that the clearance between fan and flange on radiator top tank is at least $\frac{5}{16}$ inch, and the hood lines up with the radiator core shell equally on both sides. On vehicles equipped with a fan shroud, adjust tie rods so that hood lines up properly at both ends. Tighten the radiator shell support stud nuts.

q. Fill Cooling System (par. 81).

r. Fill Engine Crankcase With Engine Oil (par. 24).

3/4-TON 4 x 4 TRUCK (DODGE)

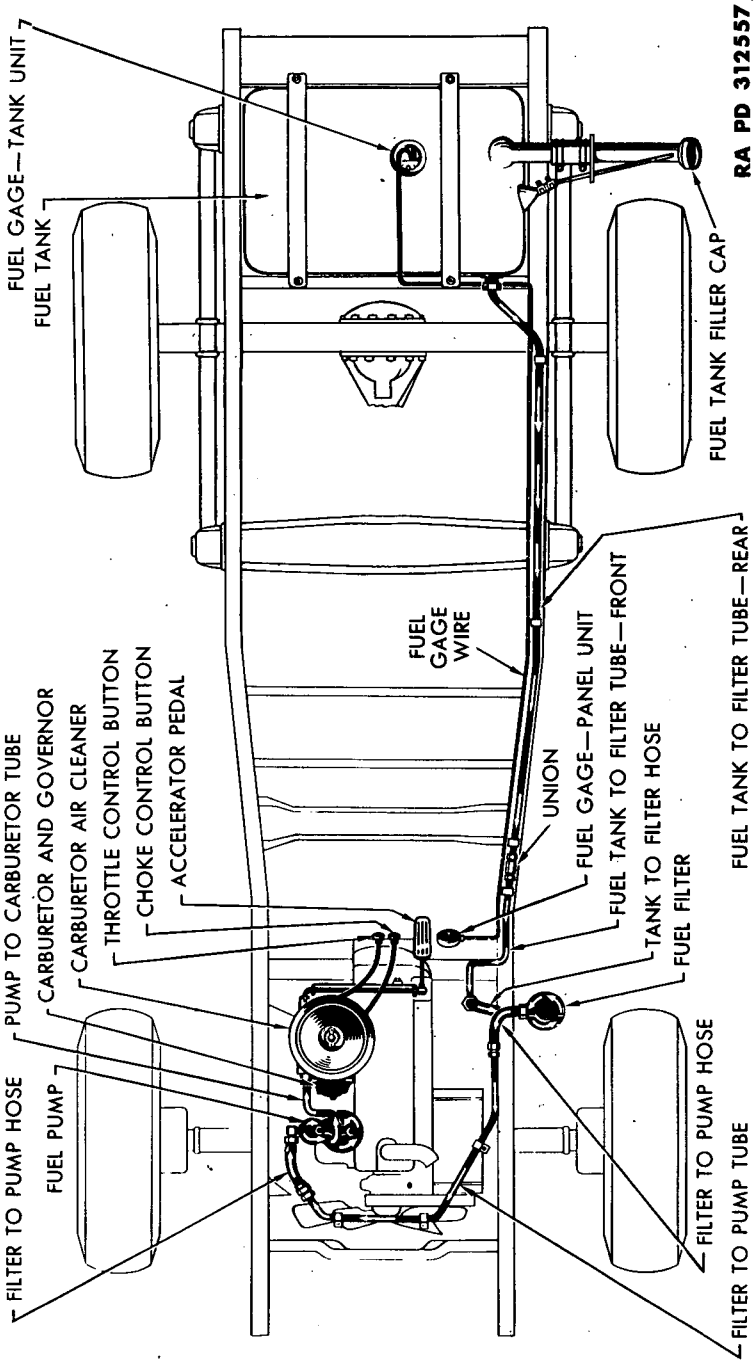

RA PD 312557

Figure 77—Fuel System

Section XVI

FUEL SYSTEM

	Paragraph
General description	68
Air cleaner	69
Carburetor and governor	70
Fuel tank	71
Fuel gage	72
Fuel pump	73
Fuel filter	74
Fuel tubes	75

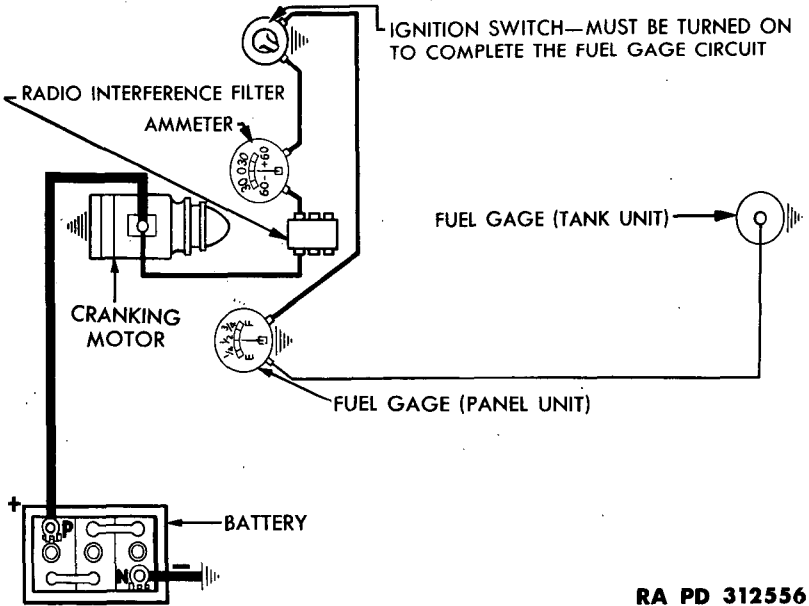

RA PD 312556

Figure 78—Fuel Gage Circuit Diagram

68. GENERAL DESCRIPTION.

a. **Fuel System** (fig. 77). A diaphragm type fuel pump is mounted on the right side of the engine crankcase and is actuated by an eccentric on the camshaft. The fuel pump draws fuel from the fuel tank, through the filter on the dash, and delivers it to the carburetor under 3 to 5½ pounds pressure. Fuel is maintained at a determined level in the carburetor bowl and discharge jets by a float actuated valve. Air enters the combustion chambers through the air cleaner, carburetor, and intake valves. As the air passes through the carburetor it picks up fuel from the discharge jets and enters the combustion chambers as a mixture of air and gasoline. The ratio of air and

3/4-TON 4 x 4 TRUCK (DODGE)

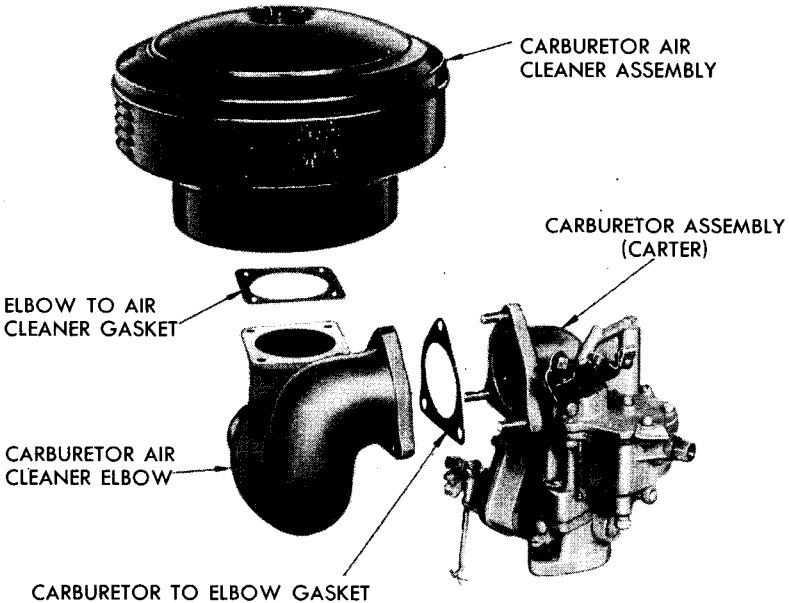
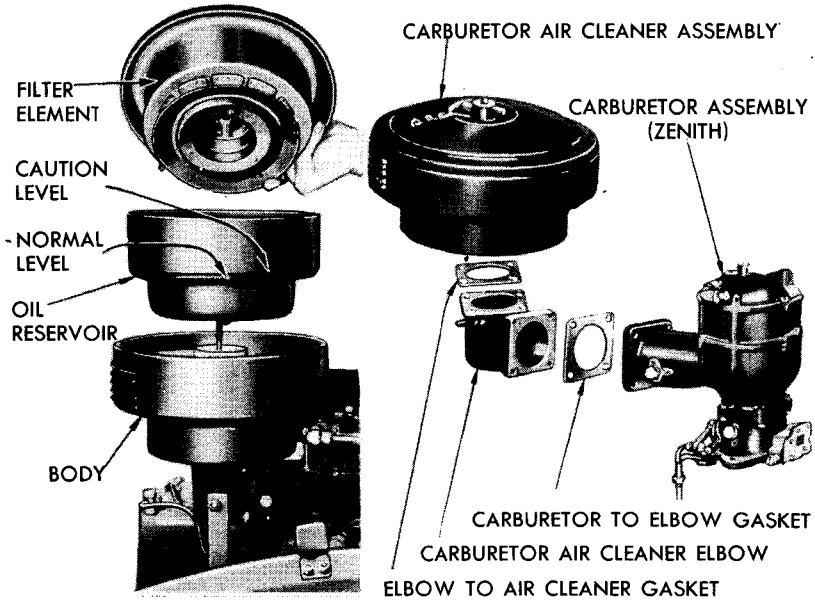

RA PD 312558

Figure 79—Carburetor Air Cleaner

FUEL SYSTEM

gasoline in the fuel mixture is governed by the amount of air passing through the air cleaner, the height of the float level, and the calibration of the carburetor jets.

b. Fuel Gage (fig. 78). The electrically operated fuel gage consists of two units; a float unit mounted in the tank and the gage unit mounted on the instrument panel.

c. Tabulated Data.

Carburetor	Zenith (Series 29) or Carter (ETW1)
Fuel pump	A-C model 1537715
Fuel line filter	Zenith F36B-2
Air cleaner	AC-A20263B
Fuel gage:	
Panel unit	Auto-Lite NG10020-D
Tank unit	Auto-Lite NG9967-T

69. AIR CLEANER.

a. Removal of Filter Element (fig. 79). Back off the wing nut and lift out the filter element which is attached to the cover. Do not allow the oil collected on the baffle to drip into the air cleaner elbow. Lift out the oil reservoir.

b. Cleaning of Filter Element. Wash the filter element thoroughly in dry-cleaning solvent and dry. Empty the old oil and clean out accumulation of dirt in the oil reservoir.

c. Installation of Filter Element (fig. 79). Place the oil reservoir in the cleaner body and fill to the marked level with fresh engine oil. Install the filter element and cover assembly. Tighten the wing nut.

d. Removal of Air Cleaner Assembly (fig. 79).

(1) REMOVE AIR CLEANER. Remove filter element (subpar. a above). Remove the four screws which attach the air cleaner body to the air cleaner elbow and stud assembly and lift off the cleaner body.

(2) REMOVE AIR CLEANER ELBOW. Remove the nut from the stud that holds the air cleaner elbow support bracket to the elbow and the screw that attaches the support bracket to the manifold. Remove the nuts from the carburetor studs which hold the air cleaner elbow to the carburetor and slide the elbow off the studs.

e. Installation of Air Cleaner Assembly (fig. 79).

(1) INSTALL AIR CLEANER ELBOW. Place the gasket on the carburetor studs and assemble the elbow to the carburetor. Fasten the elbow in place with the lock washers and nuts. Slide the support bracket on the elbow stud, and install the screw with a toothed lock washer which attaches the bracket to the intake manifold. If vehicle is equipped with a heater, place the heater hose clamp on elbow stud, then the plain washer, lock washer, and nut.

3/4-TON 4 x 4 TRUCK (DODGE)

(2) **INSTALL AIR CLEANER.** Place a new air cleaner body to elbow gasket on the elbow, then the cleaner body. Install the four cleaner body to elbow screws with toothed lock washers. Install the filter element (subpar. c above).

70. CARBURETOR AND GOVERNOR.

a. **Throttle Stop Screw and Idling Adjustments** (fig. 80). The idle adjusting screw controls the mixture of air and fuel used for closed throttle operation. Run the engine until the normal operating temperature is reached. Disconnect the windshield wiper hose at the tube leading to the intake manifold, and attach vacuum gage to the

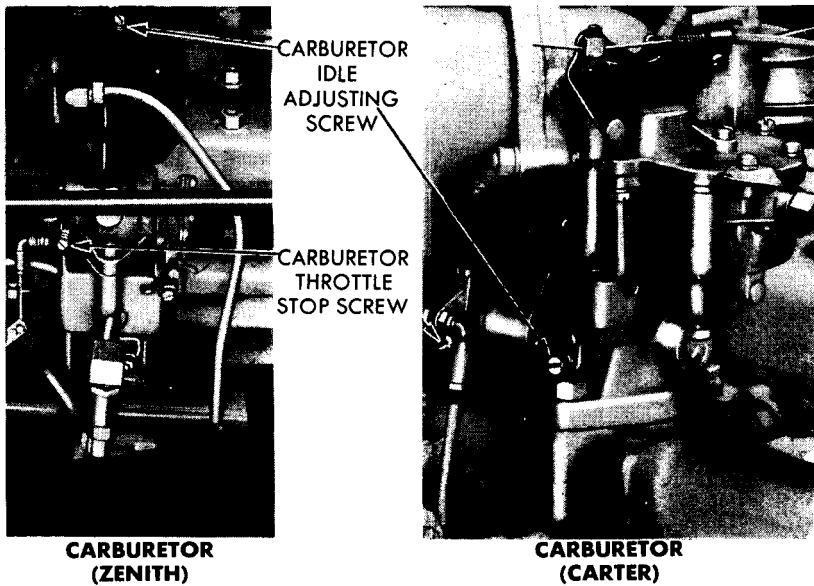

Figure 80—Carburetor Adjustments

tube. On the Zenith carburetor, turn the idle adjusting screw clockwise to make a richer mixture of fuel or counterclockwise to make a leaner mixture of fuel. On the Carter carburetor, turn screw counterclockwise for richer mixture; clockwise for leaner mixture. Turn the idling adjusting screw until the pointer on the gage shows maximum reading. If this changes the idling speed of the engine, adjust the throttle stop screw to obtain desired idling speed (clockwise to increase the engine idling speed or counterclockwise to decrease speed).

b. Adjustment of Governor on Engine.

(1) **WARM UP ENGINE AND TEST MANIFOLD VACUUM.** Run engine until normal operating temperature is reached. Manifold

FUEL SYSTEM

COMPENSATING CHANNEL PLUG
GOVERNOR SEAL
GOVERNOR AND CARBURETOR

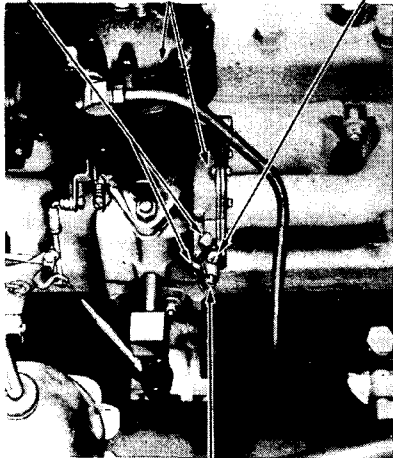

MAIN CHANNEL PLUG

COMPENSATING SPRING
ADJUSTING SCREW
COVER SHOWN CUTAWAY

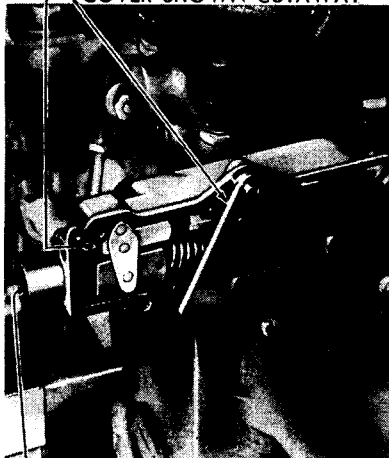

MAINSRING ADJUSTING SCREW

CARBURETOR (ZENITH)

ADJUSTING SCREW PASSAGE PLUG
GOVERNOR SEAL

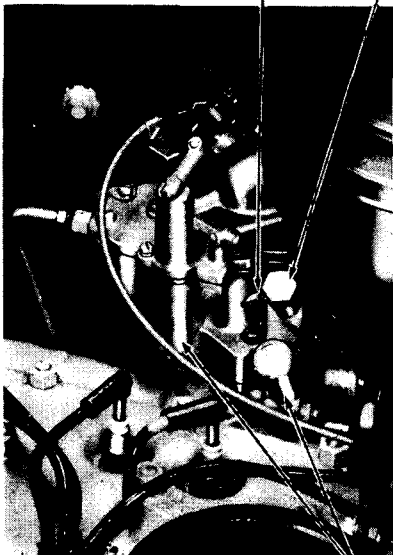

GOVERNOR AND CARBURETOR

SCREWDRIVER ENGAGING
SLOT IN ADJUSTING SCREW

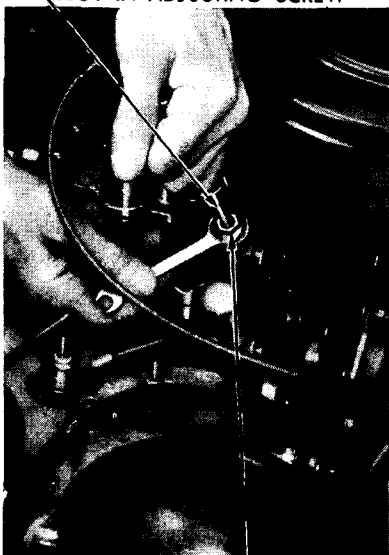

GOVERNOR ADJUSTING NUT WRENCH

CARBURETOR (CARTER)

RA PD 312582

Figure 81—Governor Adjustments with Wrench 41-W-3734

¾-TON 4 x 4 TRUCK (DODGE)

vacuum should be at least 16 inches with engine operating at full throttle (governor operating) and at least 17 inches at idling speed, with an allowable reduction for altitude. The adjusting screw, which is attached to the spring, controls the maximum engine speed.

(2) **ADJUSTMENTS OF ENGINE SPEED (fig. 81).** Remove the adjusting screw passage plug and turn the screw clockwise to decrease, or counterclockwise to increase the maximum engine speed. Adjust the governor to maximum engine speed of 3,000-3,200 revolutions per minute or a road speed of 6½ to 7½ miles per hour, low gear with no load. *NOTE: The screw adds to or subtracts from the number of active coils in the spring when it is turned, automatically calibrating the tension and stability of the spring so that it is generally possible to regulate the maximum engine speed over a considerable range by means of the adjusting screw.*

(3) **ADJUSTMENT FOR SURGE (CARTER).** If surge (continued rapid rise and fall of engine speed over a considerable range by means of throttle at full throttle) is present or occurs through change of the screw adjustment, eliminate as follows:

(a) Move the adjusting nut clockwise ¼ turn at a time with special wrench (41-W-3734), correcting the engine speed with the adjusting screw, until the surge is eliminated.

(b) *If Governor is Slow Acting* (governor too "flat"). Move the adjusting nut counterclockwise ¼ turn at a time, correcting the engine speed with the adjusting screw until surge is apparent, then remove surge as outlined (2) above. Engines operate most efficiently when the governor is adjusted to the point which just eliminates surge at full throttle. Do not forget to install adjustment passage plug and sealing wire after making adjustment.

(4) **ADJUSTMENT OF ENGINE SPEED (ZENITH) (fig. 81).** Remove the seal and main channel plug. Turn the main spring adjusting screw clockwise to increase engine speed and counterclockwise to decrease engine speed. Adjust the governor to a maximum engine speed of 3,200 revolutions per minute or to a road speed of nine miles per hour in low gear with no load.

(5) **ADJUSTMENT FOR SURGE (ZENITH) (fig. 81).** The compensating spring adjusting screw which is located under the compensating channel plug provides an adjustment to eliminate surge (continued rapid rise and fall of engine speed). If surge is experienced at full throttle and no engine deficiencies are responsible, remove the seal and plug and adjust the compensating spring adjusting screw ½ turn at a time until the surge is just eliminated. The governor operates most efficiently when the adjusting screw is turned clockwise only far enough to eliminate the surge. If the screw is turned too far clockwise, the governor will lag at full throttle. When the adjustment is satisfactory, install plug and seal with new lock wire.

c. Removal of Carburetor Assembly. Remove air cleaner assembly (par. 69). Disconnect and remove the choke control wire and tube at the carburetor. Disconnect the fuel tube at the carburetor. Disconnect the throttle control bell crank to carburetor rod from

FUEL SYSTEM

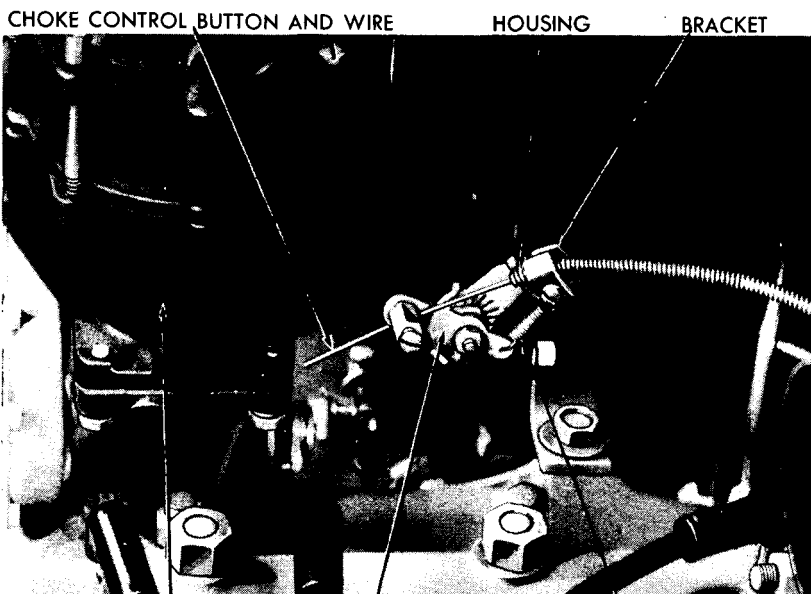

CHOKE CONTROL BUTTON AND WIRE

HOUSING

BRACKET

AIR SHUTTER LEVER

PULL-BACK SPRING

CARBURETOR ASSEMBLY (ZENITH)

CHOKE CONTROL BUTTON AND WIRE

HOUSING

BRACKET

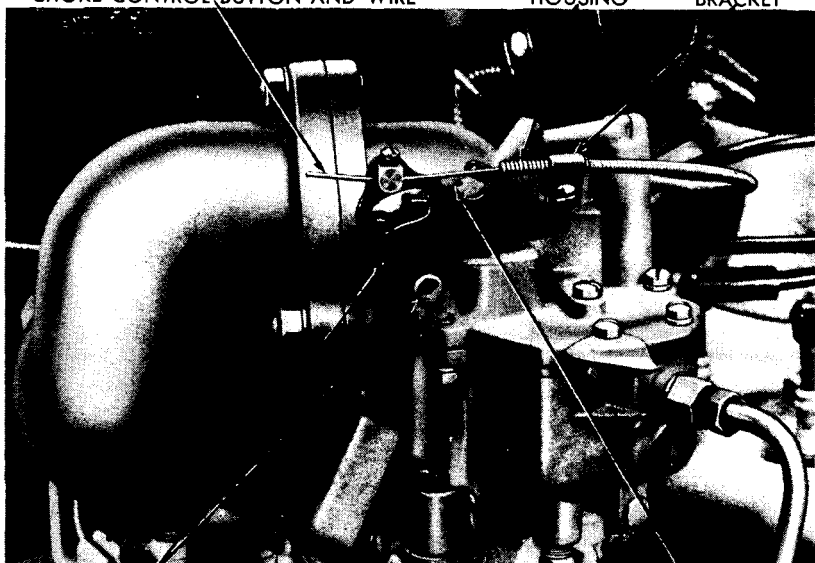

CHOKER CONTROL LEVER AND SHAFT

PULL-BACK SPRING

CARBURETOR ASSEMBLY (CARTER)

RA PD 312530

Figure 82—Choke Control Linkage

3/4-TON 4 x 4 TRUCK (DODGE)

the carburetor throttle lever. Remove the nuts from the carburetor to manifold studs and remove the carburetor and governor assembly from the engine.

d. **Installation of Carburetor Assembly.** Install a new carburetor flange gasket and place the carburetor over the manifold studs with the carburetor air intake facing the rear of the vehicle. Install the lock washers and nuts on the carburetor flange studs and tighten. Attach the throttle control bell crank to carburetor rod at the carburetor throttle lever. Install the lock washer and nut and tighten (fig. 83). Connect the fuel tube to the carburetor and tighten. Insert the choke control wire in the choke shutter lever swivel and the housing in the clip on the bracket so that the housing is flush with

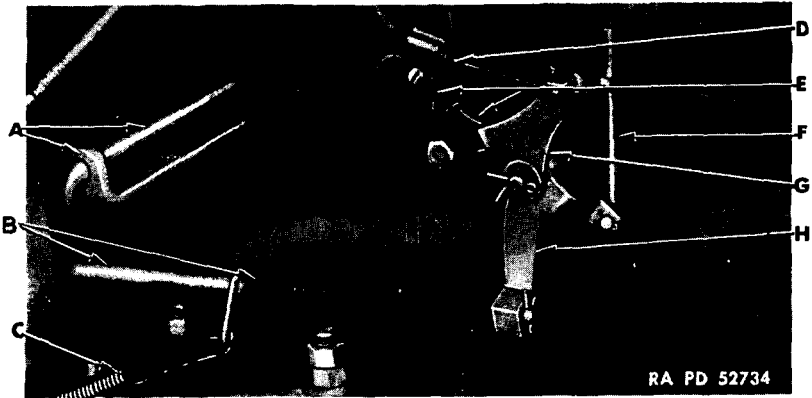

- A—ACCELERATOR SHAFT AND BRACKET
- B—ACCELERATOR SHAFT TO BELL CRANK ROD AND SPRING
- C—THROTTLE CONTROL SPRING
- D—HAND THROTTLE CONTROL WIRE AND HOUSING
- E—HAND THROTTLE CONTROL BRACKET AND WIRE HOUSING CLIP
- F—BELL CRANK TO CARBURETOR ROD
- G—HAND THROTTLE CONTROL LEVER
- H—BELL CRANK

Figure 83—Throttle Control Linkage

the forward end of the clip. Tighten the clip. Push the control button all the way in and back off about 1/16 inch, then tighten the wire in the air shutter swivel. Install air cleaner assembly (par. 69). Adjust engine idling speed (subpar. a above).

e. **Removal of Choke Control Wire** (fig. 82). Disconnect battery cable to prevent short circuit. Disconnect choke control wire and housing at the carburetor. Pull wire and housing from the short piece of loom holding the choke housing to the throttle housing. Straighten the housing and pull the control button and wire from the housing.

FUEL SYSTEM

f. Installation of Choke Control Wire (fig. 82). Push control wire through the housing, starting at the instrument panel end. Then push the housing and wire through the loom on throttle control housing and into its original position. Insert the choke control wire in the choke air shutter lever swivel and the housing in the clip on the bracket so that the housing is flush with the forward end of the clip. Tighten the clip. Push dash control button all the way in and back off about $\frac{1}{16}$ inch. Hold the choke air shutter lever forward and tighten the wire in the air shutter swivel. Connect battery cable. Adjust engine idling speed (subpar. a above).

g. Removal of Throttle Control Wire (fig. 83). Disconnect battery cable to prevent short circuit. Disconnect the throttle wire and housing at the throttle bell crank which is mounted on the manifold bracket. Then pull the wire and housing from the short piece of loom holding the throttle housing to the choke housing. Straighten the housing and pull the control button and wire from the housing.

h. Installation of Throttle Control Wire (fig. 83). Push control wire through the housing, starting at the instrument panel end. Push the housing and wire through the loom on choke housing and into its original position. Connect the throttle control wire and housing to the manifold and tighten the clip screw. Insert the throttle control wire in the block on the throttle control bell crank. With the throttle button on the dash pushed in and the throttle closed, tighten the set screw on the block. Connect battery cable. Adjust engine idling speed (subpar. a above).

71. FUEL TANK.

a. Removal. Remove the fuel tank drain plug and drain the fuel from the tank. Disconnect the filler tube hose between the tank and the filler tube by loosening the clamp screws and separating the hose from the tank connection and filler tube. Disconnect the fuel filter to tank tube at the fuel tank. Remove the fuel tank rear support strap cap screws. Disconnect the fuel gage wire as the tank is being removed.

b. Installation. Connect the fuel gage wire and lift the tank into place. Install the fuel tank rear support lock washers and cap screws. Install the drain plug. Connect the tank to fuel filter tube at the tank. Insert filler tube and hose. Connect the hose to the filler tube and tank connection and tighten the two clamp screws. Make sure that the filler pipe is installed in the flexible hose connection, so that at least $\frac{5}{8}$ inch to $\frac{3}{4}$ inch space exists between the filler pipe and the fuel tank connection, particularly on the Ambulance model.

72. FUEL GAGE.

a. Removal of Instrument Panel Unit. Disconnect wires from the gage. Remove the two nuts which hold the mounting bracket to the instrument panel and remove the gage from driver's side of the instrument panel.

3/4-TON 4 x 4 TRUCK (DODGE)

b. **Installation of Instrument Panel Unit** (fig. 84). Place gage in the instrument panel from the driver's side and install the mounting bracket on the two studs of the gage. Install the two attaching nuts with a standard lock washer under each nut. Connect the small blue wire to the left post of the gage unit. On all models except the Ambulance, connect green and white wire to the right post of the unit. On the Ambulance, connect green and white wire, also red and white wire, to right post of the unit.

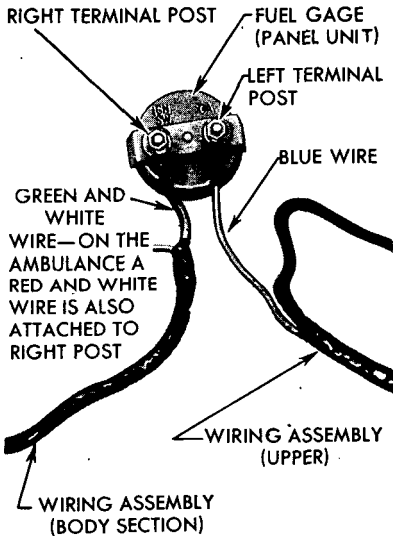

RA PD 52901

Figure 84—Fuel Gage Terminals



RA PD 52794

Figure 85—Fuel Gage (Tank Unit)

c. **Removal of Tank Unit** (fig. 85). Remove the screws which hold the fuel gage inspection plate. Disconnect the gage wire and remove the five screws from gage. Lift the gage out through the inspection hole.

d. **Installation of Tank Unit** (fig. 85). It is important that the gage gasket form a tight seal in order to prevent fuel leakage. If the gasket is not in good condition, use a new one. Assemble the tank unit to the fuel tank and tighten the fastening screws. Connect the wire and install the inspection plate.

73. FUEL PUMP.

a. **Cleaning of Strainer Bowl and Screen** (fig. 86). Loosen the strainer bowl bail screw by hand and swing the bowl bail out of the

FUEL SYSTEM

way. Remove bowl, gasket, and screen from the fuel pump body. Wash the strainer screen and bowl in dry-cleaning solvent. Assemble the screen in the pump top cover, making certain that it fits snugly around the gasoline inlet and the edges of the casting. Then place a new bowl gasket next to the screen. Hold the bowl firmly to the gasket, move the bail in place, and tighten the bail screw securely by hand.

b. Removal of Fuel Pump Assembly. Remove the heat shield stud wing nut and loosen the nut on the exhaust manifold stud. Disconnect the fuel pump to carburetor tube at the fuel pump. Discon-

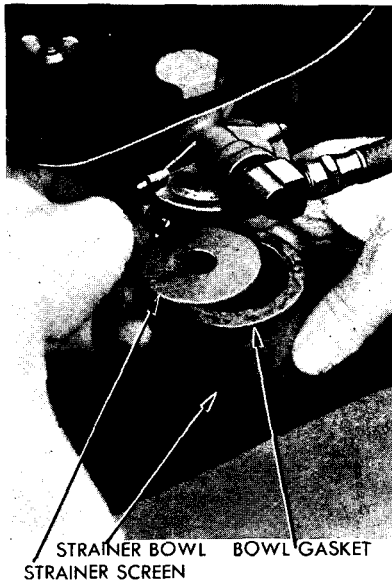

RA PD 52793



RA PD 52791

Figure 86—Removing Fuel Pump Bowl and Strainer Screen **Figure 87—Removing Fuel Line Filter Element**

nect the fuel filter to fuel pump flexible tube at the fuel pump. Remove the fuel pump mounting cap screws and lift off the fuel pump.

c. Installation of Fuel Pump Assembly. Place the fuel pump in position on the engine with a new gasket between fuel pump flange and cylinder block. Install the lock washers and cap screws and tighten. Connect the fuel filter to fuel pump flexible tube at the fuel pump. Connect the fuel pump to carburetor tube at the fuel pump. Slide the heat shield into position between the manifold stud washer and manifold stud flange, also over the stud on the fuel pump. Hold shield in place and tighten manifold stud nut. Install the lock washer and wing nut on fuel pump stud.

3/4-TON 4 x 4 TRUCK (DODGE)**74. FUEL FILTER.**

a. **Draining of Filter.** Remove drain plug in filter bowl to drain accumulated water or dirt from bowl.

b. **Cleaning of Filter Element (fig. 87).** Remove the filter bowl nut and pull filter bowl and gasket off filter. Turn the filter element knurled nut counterclockwise until the element can be removed from the element stud. Wash the element in dry-cleaning solvent. Separate the disks to remove all dirt and lint between the disk surfaces. *Do not disassemble the element.* Assemble the filter element to the filter head and tighten the element nut fingertight. *Use no tools and never twist the element.* Install a new gasket on the filter bowl and install bowl. Insert the bowl nut gasket over the stud and install and tighten the bowl nut.

c. **Removal of Fuel Filter Assembly.** Disconnect the two flexible tubes at the filter. Open the clip held by the filter mounting flange cap screw and move the wires out of the way. Remove the two cap screws from the fuel filter mounting flange.

d. **Installation of Fuel Filter Assembly.** Insert the right cap screws through mounting flange with a toothed lock washer under the cap screw head. Insert the left cap screw through mounting flange with the wire clip between the toothed lock washer and mounting flange. Place toothed lock washer on each cap screw so that it will be between the mounting flange and dash. Hold the filter in place against dash and tighten cap screws. Bend the clip over wiring. Connect the two flexible tubes to the filter.

75. FUEL TUBES.

a. **Removal of Tank to Fuel Filter Tube (Rear Section).** Disconnect the fuel tube at the tank. Disconnect the tube at the union near the brake pedal pivot bracket. Open the three clips holding the fuel tube to the lower flange of the frame side member and remove tube.

b. **Installation of Tank to Fuel Filter Tube (Rear Section).** Place the fuel tube in position and bend the three clips over the tube. Connect the tube at the tank. Connect the tube rear section to the front tube union near the brake pedal pivot bracket.

c. **Removal of Tank to Fuel Filter Tube (Front Section).** Disconnect the fuel tube at the union near the brake pedal pivot bracket. Disconnect the fuel tube from the flexible hose near the filter. Open the clip holding the fuel tube at master cylinder bracket. Back off the front wheel brake shoe cams so that the brake pedal can be depressed to the floor panel. Push the brake pedal all the way down and pull out the cotter pin and clevis pin which connects brake master cylinder push rod end to the brake pedal. Release the brake pedal and slide the push rod clevis end off its connection at the pedal and

FUEL SYSTEM

push it back past the pedal so that the front end of the push rod can be lowered slightly, creating sufficient clearance to permit the removal of the tube without bending or distorting it.

d. Installation of Tank to Fuel Filter Tube (Front Section).

Position the fuel tube and connect at the union near the brake pedal pivot bracket. Connect the tube at the flexible hose near the filter. Then bend the clip over the tube located at the master cylinder bracket. Move brake pedal and push rod end forward so clevis pin can be installed. Insert new cotter pin in clevis pin and spread cotter pin. Adjust front wheel brake shoes (par. 151).

e. Removal of Fuel Filter to Fuel Pump Tube.

- (1) REMOVE BATTERY (6-VOLT SYSTEM ONLY) (par. 88).
- (2) REMOVE HOOD (par. 178).
- (3) REMOVE WATER PUMP ASSEMBLY (par. 85).
- (4) REMOVE RADIATOR CORE (par. 86).
- (5) REMOVE FUEL TUBE. Disconnect fuel tube from the flexible hose at the fuel filter end. Disconnect fuel tube from the flexible hose at the fuel pump end. Remove the two fuel tube clip self-tapping cap screws at the frame front cross member. If vehicle is equipped with 6-volt electrical system, remove the fuel tube clip bolt and nut at the battery tray and remove the tube. If vehicle is equipped with 12-volt electrical system, remove the fuel tube clip bolt and nut from the frame left side member and remove the tube.

f. Installation of Fuel Filter to Fuel Pump Tube.

(1) INSTALL FUEL TUBE. Work the fuel pump end of the tube down between engine and left dust shield and up between the engine and right dust shield, then push in position over frame front cross member. Install the two fuel tube clip self-tapping cap screws with a toothed lock washer between each screw head and clip. Connect the fuel tube to the flexible hose at the fuel filter end. Connect fuel tube to the flexible hose at water pump end. If vehicle is equipped with 6-volt electrical system, install the fuel tube bolt and nut with a toothed lock washer under the bolt head and a toothed lock washer under the nut at the battery tray. If the vehicle is equipped with 12-volt electrical system, install the fuel tube bolt and nut with a toothed lock washer under the bolt head and a toothed lock washer under the nut at the frame left side member.

- (2) INSTALL RADIATOR CORE (par. 86).
- (3) INSTALL WATER PUMP ASSEMBLY (par. 85).
- (4) INSTALL BATTERY (6-VOLT SYSTEM ONLY) (par. 88).
- (5) INSTALL HOOD (par. 178).

g. Fuel Tube Repair.

(1) CUT NEW TUBE WITH TUBE CUTTER. Measure tube for length desired and cut with tube cutter.

3/4-TON 4 x 4 TRUCK (DODGE)**FUEL TUBE LENGTHS**

Fuel pump to carburetor tube.....	22 in.
Fuel filter to fuel pump tube.....	46½ in.
Fuel tank to fuel filter front tube.....	31 in.
Fuel tank to fuel filter rear tube.....	91¾ in. (Carryall)
Fuel tank to fuel filter rear tube.....	98¾ in. (Ambulance)
Fuel tank to fuel filter rear tube.....	75¾ in. (Command and Weapon Carrier)

(2) **BEND TUBING WITH TUBING BENDER.** Use removed tube as a template or guide and form the tube to the same shape as the tube removed.

(3) **FLARE ENDS OF TUBE WITH FLARING TOOL.** Slide the attaching nuts on each end of the fuel tube and flare each end of the tube with flaring tool.

Section XVII

EXHAUST SYSTEM

	Paragraph
General description	76
Tail pipe	77
Muffler	78
Exhaust pipe	79

76. GENERAL DESCRIPTION.

a. The purpose of the exhaust system is to carry the burned gases away from the vehicle and reduce exhaust noise.

77. TAIL PIPE.

a. **Removal** (fig. 88). Remove the muffler tail pipe bracket and the lower part of the muffler rear support bracket. Remove the support clamp bolts and pull the tail pipe off muffler.

b. **Installation** (fig. 88). Slide the tail pipe on the muffler flange and fasten the tail pipe bracket to the frame side member. Assemble the lower half of the muffler rear bracket to the frame side member and install the rear support clamp bolts, lock washers, and nuts.

78. MUFFLER.

a. **Removal** (fig. 88). Remove the muffler tail pipe (par. 77). Remove the U-clamp at the front of the muffler and pull the muffler from the exhaust pipe.

b. **Installation** (fig. 88). Slide the muffler flange on the exhaust pipe and assemble the U-clamp in the muffler front bracket, being sure that the saddle is in place between the exhaust pipe and the bracket. Install the lock washers and nuts on the U-clamp and tighten. Install the muffler tail pipe (par. 77).

79. EXHAUST PIPE.

a. **Removal** (fig. 88). Disconnect the exhaust pipe at the manifold. Remove the two nuts from the U-bolt at the front of the muffler and pull out the exhaust pipe.

b. **Installation** (fig. 88). Slide the end of the exhaust pipe into the muffler flange and attach the exhaust pipe to the manifold flange. Assemble the U-bolt in the muffler front bracket, being sure that the saddle is in place between the exhaust pipe and the bracket.

3/4-TON 4 x 4 TRUCK (DODGE)

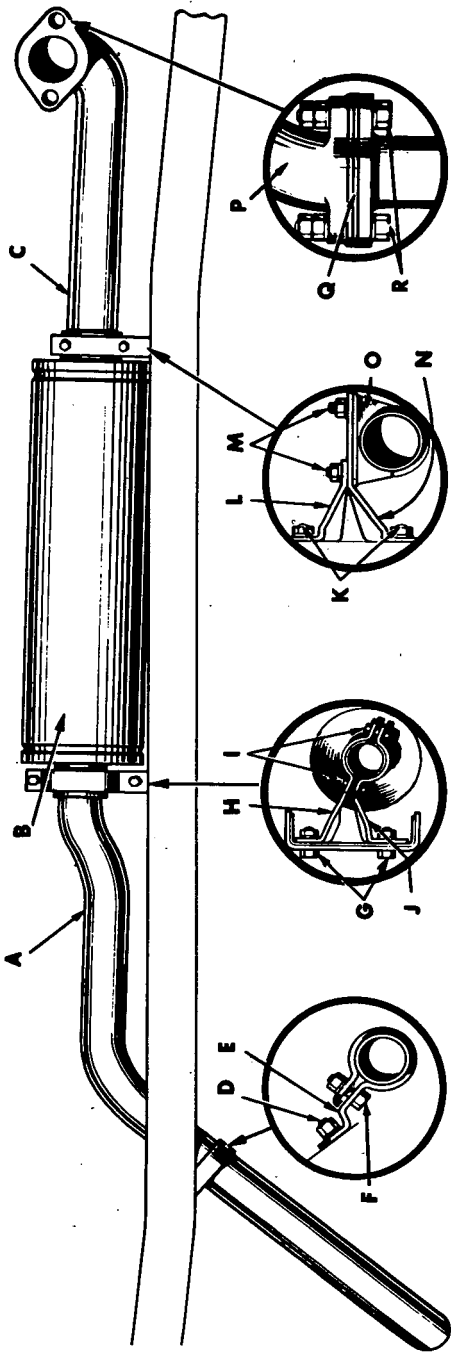

- A—MUFFLER TAIL PIPE
- B—MUFFLER ASSEMBLY
- C—EXHAUST PIPE
- D—MUFFLER TAIL PIPE BRACKET TO FRAME BOLT, NUT AND LOCK WASHER
- E—MUFFLER TAIL PIPE BRACKET
- F—MUFFLER TAIL PIPE BRACKET CLAMP BOLT, NUT AND LOCK WASHER
- G—MUFFLER REAR SUPPORT BRACKET TO FRAME BOLT, NUT AND LOCK WASHER
- H—MUFFLER REAR SUPPORT BRACKET—UPPER
- I—MUFFLER REAR SUPPORT BRACKET CLAMP BOLT, NUT AND LOCK WASHER

- J—MUFFLER REAR SUPPORT BRACKET—LOWER
- K—MUFFLER FRONT BRACKET TO FRAME BOLT, NUT AND LOCK WASHER
- L—MUFFLER FRONT BRACKET—UPPER
- M—EXHAUST PIPE CLAMP "U" BOLT, NUT AND LOCK WASHER
- N—MUFFLER FRONT BRACKET—LOWER
- O—EXHAUST PIPE CLAMP SADDLE
- P—EXHAUST MANIFOLD
- Q—EXHAUST PIPE FLANGE GASKET
- R—EXHAUST PIPE FLANGE BOLT AND NUTS

RA PD 318327

Figure 88—Exhaust System

Section XVIII

COOLING SYSTEM

	Paragraph
General description	80
Maintenance	81
Fan belt	82
Hose	83
Thermostat	84
Water pump and fan	85
Radiator	86

80. GENERAL DESCRIPTION.

a. **General** (fig. 89). The purpose of the cooling system is to maintain efficient operating temperature of the engine. This is accomplished by thermostatically controlling the circulation of coolant around the cylinder walls and through the radiator.

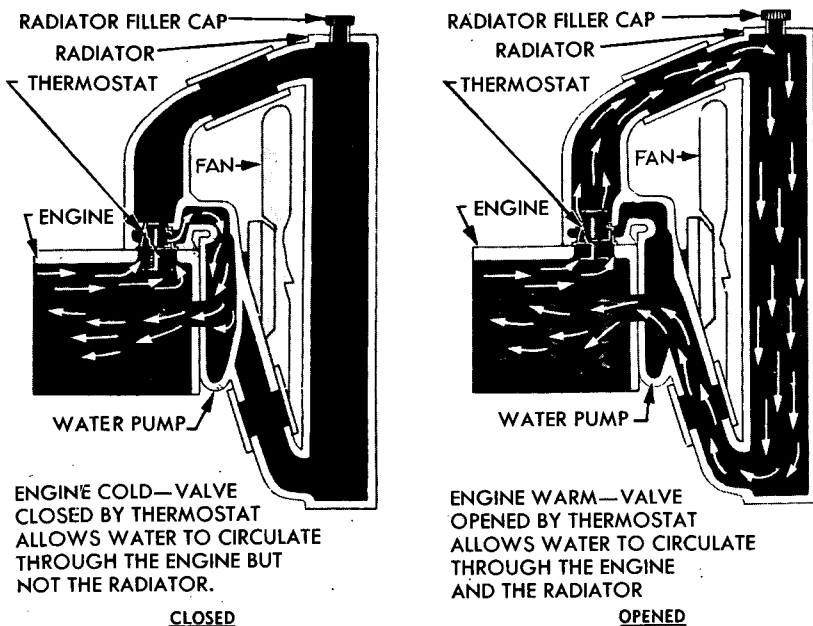

RA PD 58353

Figure 89—Cooling System Thermostat Operation

b. **Thermostat Control** (fig. 89). When a cold engine is started, a thermostat prevents the circulation of the cooling solution through the radiator. A bypass allows the coolant to circulate only in the water jackets of the engine until normal operating temperature has

¾-TON 4 x 4 TRUCK (DODGE)

been reached. When the temperature as shown by the thermometer on the instrument panel reaches approximately 157°F, the thermostat starts to open, allowing some of the coolant to circulate through the radiator. At approximately 183°F the thermostat is fully open, allowing unrestricted circulation of the coolant.

c. Radiator Cap. The radiator cap is spring-loaded, forming a closed cooling system to prevent loss of cooling liquids. Should excessive pressure develop, the radiator cap releases at a pressure from 1½ to 2½ pounds allowing the system to vent through the overflow pipe in the radiator filler neck above the radiator cap seat.

81. MAINTENANCE.

a. Draining Cooling System (fig. 90).

(1) **DRAIN RADIATOR.** Remove the filler cap slowly to permit pressure to escape through the vent in the cap if the radiator is hot.

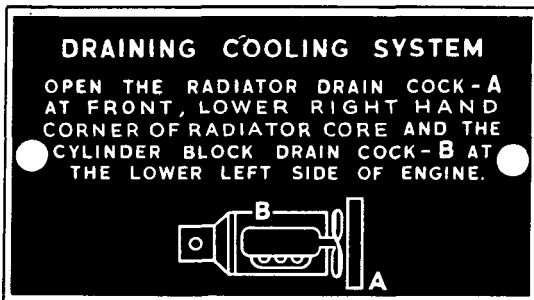

RA PD 52790

Figure 90—Cooling System Drain Caution Plate

Open the radiator drain cock at front lower right-hand corner of radiator core. If cooling system contains antifreeze, drain in pan and save.

(2) **DRAIN CYLINDER BLOCK.** Open the drain cock at the lower edge of the water jacket on the left side of the engine. **NOTE:** *Draining the radiator alone will not completely drain the cylinder block.*

b. Filling Cooling System. Close the radiator drain cock as well as the drain cock at the lower edge of the water jacket on the left side of the engine. Fill the system with coolant to a level 2¼ inches below the top of the filler neck. The capacity of the cooling system is 18 quarts. Turn filler cap all the way to the right to seal the system.

c. Flushing Cooling System. If dirty water has been used in the cooling system, the system can be flushed to some extent if water supply and hose are available.

(1) **REMOVE RADIATOR HOSE—UPPER AND LOWER** (par. 83).

(2) **REMOVE THERMOSTAT FROM CYLINDER HEAD** (par. 84). Then install thermostat housing without thermostat.

COOLING SYSTEM

(3) **FLUSH RADIATOR CORE AND ENGINE WATER JACKETS.** Place end of water hose in radiator filler opening and wrap cloth around connection to hold some of the water pressure. Turn on water and allow water to flow through radiator until water is clean as it leaves radiator. Place end of water hose in opening at the thermostat housing and allow water to flow through the engine water jackets until water is clean as it leaves water jackets.

(4) **INSTALL THERMOSTAT** (par. 84).

(5) **INSTALL RADIATOR HOSE—UPPER AND LOWER** (par. 83).

(6) **FILL COOLING SYSTEM** (subpar. b above).

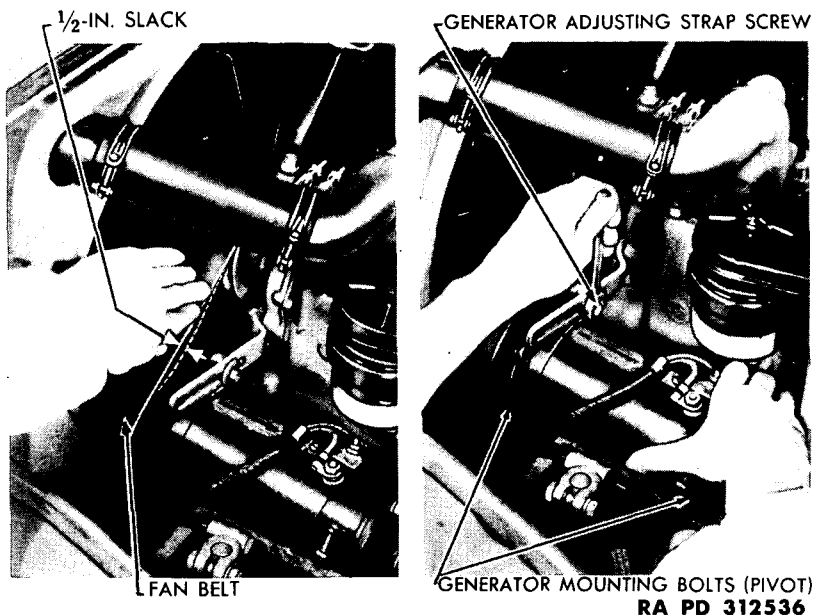

Figure 91—Adjusting Fan Belt

82. FAN BELT.

a. **Adjustment of Fan Belt** (fig. 91). If the fan belt has slack greater than $\frac{1}{2}$ inch, it should be adjusted. Loosen the generator mounting bracket pivot bolts. Then loosen the adjusting strap locking screw or bolt. Pull out on the generator until the belt is just snug. Hold the generator in this position and tighten the adjusting strap lock screw and the generator bracket pivot bolts. Do not overtighten the belt by moving the generator with a pry bar, as too tight a belt will damage the generator or water pump bearings.

b. **Replacement of Fan Belt.** Loosen the generator to mounting bracket pivot bolts and adjusting strap screw or bolt. Push the generator toward the engine as far as it will go and remove belt. Then install new belt and adjust as explained in subparagraph a above.

3/4-TON 4 x 4 TRUCK (DODGE)**83. HOSE.****a. Replacement Procedure.**

- (1) DRAIN RADIATOR (par. 81).
- (2) REPLACE INLET AND OUTLET HOSE (fig. 92). Loosen hose clamp screws and pull off hose. Install new hose and tighten clamp screws securely.
- (3) REPLACE BYPASS HOSE. Loosen the two hose clamp screws connecting the hose to water pump bypass elbow and the cylinder head water outlet elbow. Remove bypass elbow cap screws and pull the bypass elbow off the cylinder head water outlet elbow. Slide a new hose on the bypass elbow, then the two clamps over the hose. Slide the hose on the water outlet elbow and tighten the two clamp screws. Install the bypass elbow cap screws and lock washers.
- (4) FILL RADIATOR (par. 81).

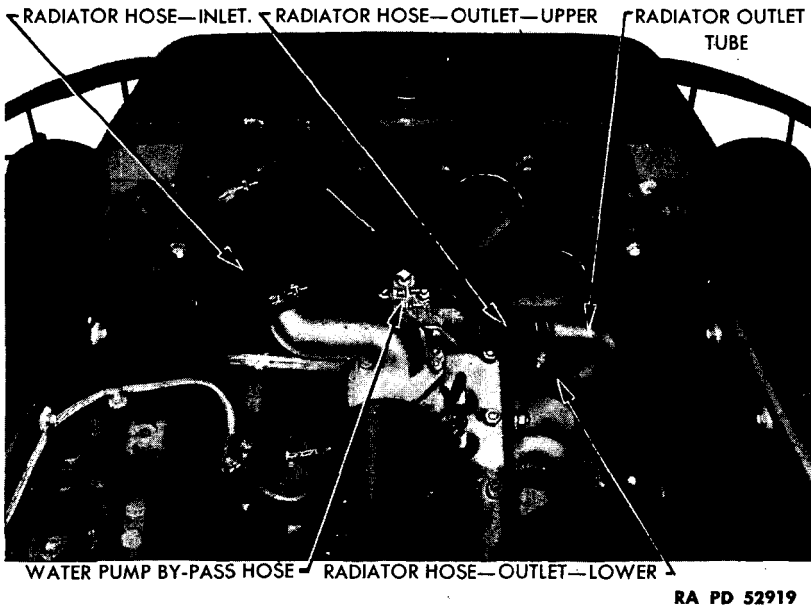

RA PD 52919

Figure 92—Cooling System Hose**84. THERMOSTAT.**

- a. Removal (fig. 93).** Drain the radiator (par. 81). Loosen the radiator inlet hose clamp screws. Remove the two bypass elbow to water pump cap screws. Then remove the two cylinder head water outlet elbow cap screws and remove the elbow assembly, being careful not to damage the thermostat. Lift the thermostat from the cylinder head (fig. 93).
- b. Testing.** Heat a pan of water to 160°F by the thermometer, suspend thermostat in water and note whether it begins to open.

COOLING SYSTEM

Remove thermostat, heat the water to 185°F and suspend thermostat in water. If it opens fully, it is functioning properly.

c. Installation (fig. 93).

(1) **INSTALL THERMOSTAT.** Place a new outlet elbow gasket on cylinder head; also a new bypass elbow gasket on the water pump. Install the thermostat in the cylinder head, bellows down. Turn the thermostat so that the bypass openings face toward the radiator and to the rear of the vehicle, leaving the two wide faces to the right and left. Place the upper gasket on the top shoulder of the thermostat.

(2) **INSTALL WATER OUTLET AND BYPASS ASSEMBLY.** Place the water outlet elbow and bypass elbow assembly in position and slide the radiator inlet hose in place. Install the bypass elbow to water

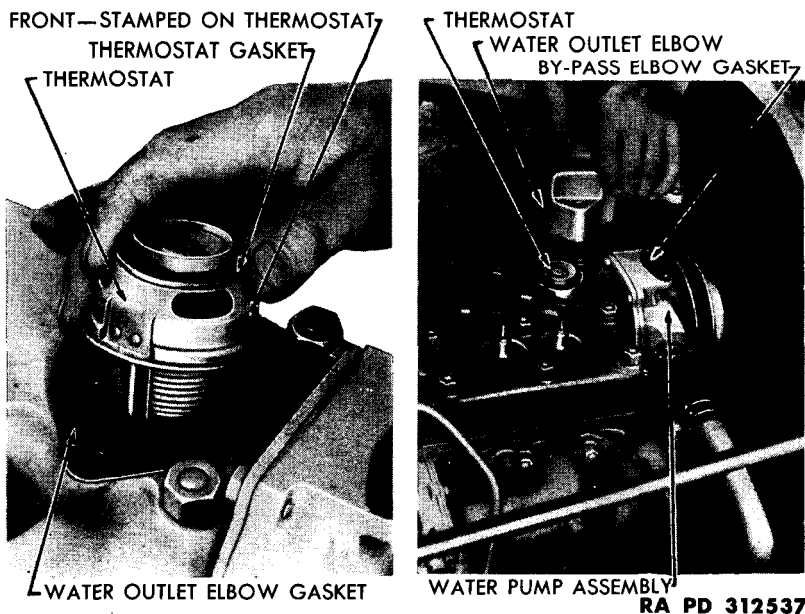

Figure 93—Installing Thermostat

pump cap screws and lock washers. Then install the water outlet elbow cap screws and lock washers. Tighten the radiator inlet hose clamp screws.

(3) **FILL COOLING SYSTEM** (par. 81).

85. WATER PUMP AND FAN.

a. **Removal of Water Pump and Fan (Vehicles without Fan Shroud).**

(1) **DRAIN RADIATOR AND DISCONNECT WATER HOSE.** Open the radiator drain cock and drain radiator. Disconnect radiator inlet hose

3/4-TON 4 x 4 TRUCK (DODGE)

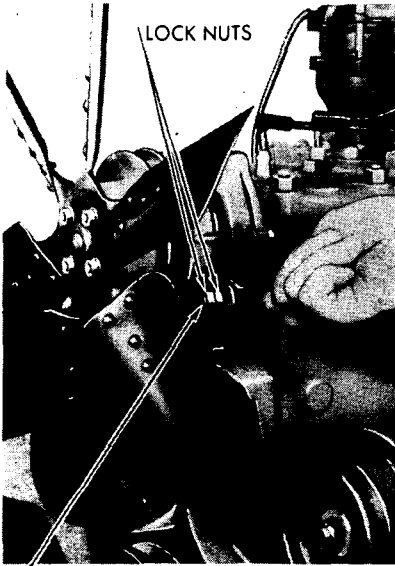

LOCK NUTS

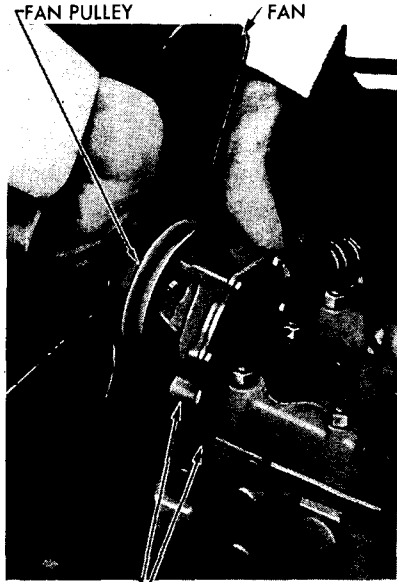

FAN PULLEY

FAN

WATER PUMP BODY STUD

WATER PUMP PUMP TO BLOCK GASKET

VEHICLES WITHOUT FAN SHROUD

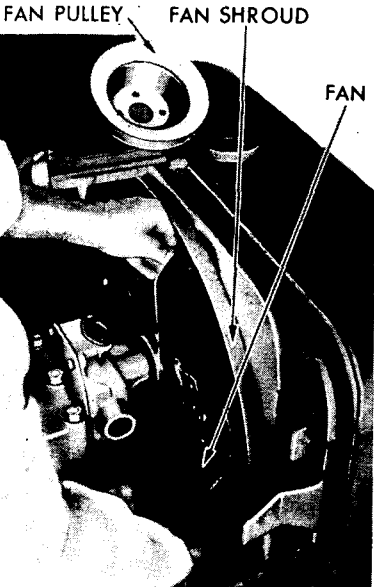

FAN PULLEY

FAN SHROUD

FAN

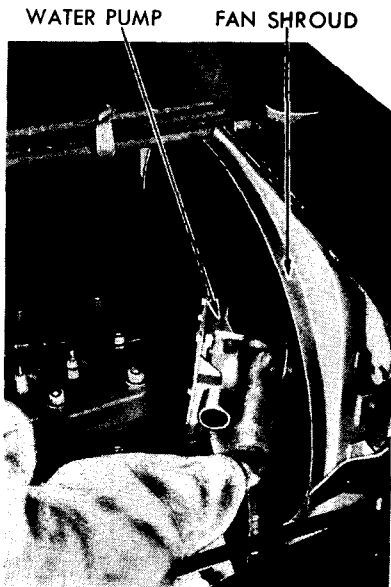

WATER PUMP

FAN SHROUD

VEHICLES WITH FAN SHROUD

RA PD 312538

Figure 94—Removing Water Pump

COOLING SYSTEM

at radiator and radiator outlet hose at water pump. Also disconnect heater hose at water pump if vehicle is equipped with heater.

(2) REMOVE GENERATOR ADJUSTING STRAP AND FAN BELT. Loosen the generator mounting pivot bolt nuts. Remove the adjusting strap from the water pump mounting stud. Push the generator toward the engine and remove the fan belt.

(3) REMOVE CYLINDER HEAD WATER OUTLET ELBOW ASSEMBLY. Remove the bypass elbow to water pump cap screws. Remove the two cap screws from cylinder head water outlet elbow and carefully lift off the elbow assembly. Do not damage the thermostat.

(4) REMOVE WATER PUMP AND FAN BLADE ASSEMBLY (fig. 94). Install two nuts on each stud and lock the nuts together. Turn the inside nut counterclockwise and screw the studs out of the block. Lift the water pump and fan blade assembly from the cylinder block.

(5) REMOVE FAN BLADE ASSEMBLY FROM WATER PUMP. Remove the fan hub cap screws and lift the fan blade assembly and pulley from the water pump.

b. Installation of Water Pump and Fan (Vehicles without Fan Shroud).

(1) INSTALL FAN BLADE ASSEMBLY ON WATER PUMP. Place the pulley and fan blade with reinforcing plate toward pulley on the fan hub, install lock washers and attaching cap screws and tighten the cap screws.

(2) INSTALL WATER PUMP AND FAN ASSEMBLY. Hold the pump and fan blade assembly in place and screw the studs into the cylinder block. Place the short stud nearest the manifold, the medium length stud at bottom center, and the long stud at the point where the generator adjusting strap is fastened. Tighten each of the studs by locking two nuts together. Place the generator adjusting strap on the water pump mounting stud. Install a toothed lock washer and nut on the mounting stud holding the adjusting strap, but do not tighten. Then place a lock washer and nut on the other two studs and tighten.

(3) INSTALL CYLINDER HEAD WATER OUTLET ASSEMBLY. Place a new outlet elbow gasket on cylinder head, also a new bypass elbow gasket on the water pump. See that the upper gasket on the top shoulder of the thermostat is in good condition, then place the water outlet elbow and bypass elbow assembly in position and slide the radiator inlet hose in place. Install the bypass elbow to water pump cap screws and lock washers and tighten. Then install the water outlet elbow cap screws and lock washers and tighten.

(4) INSTALL GENERATOR ADJUSTING STRAP AND FAN BELT. Attach the adjusting strap to the generator bracket with toothed lock washer between the cap screw and generator bracket. If a bolt and nut is used, install a toothed lock washer between bolt head and strap and one between bolt nut and generator bracket. Tighten the strap at the water pump mounting stud. Push the generator toward the engine as far as it will go, and install and adjust fan belt (par. 82).

3/4-TON 4 x 4 TRUCK (DODGE)

(5) **CONNECT WATER HOSE AND FILL RADIATOR.** Connect and tighten radiator inlet hose at radiator, and outlet hose at water pump. Connect and tighten heater hose at water pump if vehicle is equipped with heater. Close radiator drain cock and fill with coolant.

c. Removal of Water Pump and Fan (Vehicles with Fan Shroud).

(1) **DRAIN RADIATOR AND DISCONNECT HOSE.** Drain the radiator. Remove upper radiator hose and disconnect lower hose from water pump. Remove two cap screws which hold the bypass hose elbow to the top of the water pump.

(2) **REMOVE FAN AND PULLEY** (fig. 94). Remove fan belt. Disconnect the right radiator tie rod at the radiator. Remove cap screws

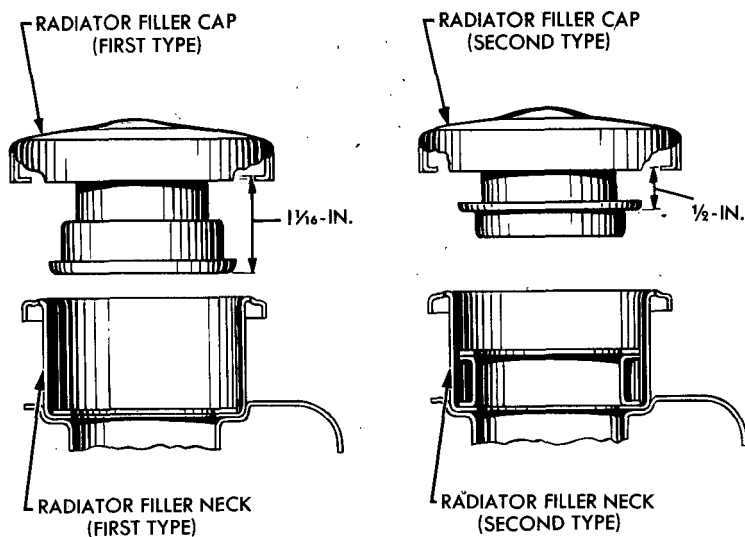

RA PD 52918

Figure 95—Radiator Filler Caps

which hold fan and pulley to fan pulley hub. Move the fan assembly toward radiator and remove pulley. Tip fan blade assembly as shown in figure 94 and lift it out.

(3) **REMOVE WATER PUMP** (fig. 100). Remove the nuts and lock washers from the water pump attaching studs and move the pump forward and off the studs.

d. Installation of Water Pump and Fan (Vehicles with Fan Shroud).

(1) **INSTALL WATER PUMP.** Slide the pump over the attaching studs and install standard lock washers and nuts.

COOLING SYSTEM

(2) **INSTALL FAN BLADES** (fig. 94). Place pulley in position. Insert fan between radiator shroud and water pump as shown in figure 94, with reinforcing plate toward pulley. Move fan into position over water pump hub and install four attaching cap screws with standard lock washer under the head of each cap screw. Attach radiator tie rod to radiator. Install fan belt.

(3) **CONNECT HOSE AND FILL RADIATOR.** Install the two cap screws which hold the bypass elbow to the water pump. Connect lower hose to water pump and install upper hose. Fill cooling system (par. 81).

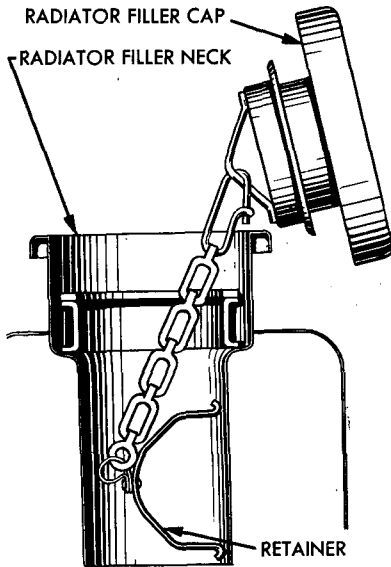

RA PD 52920

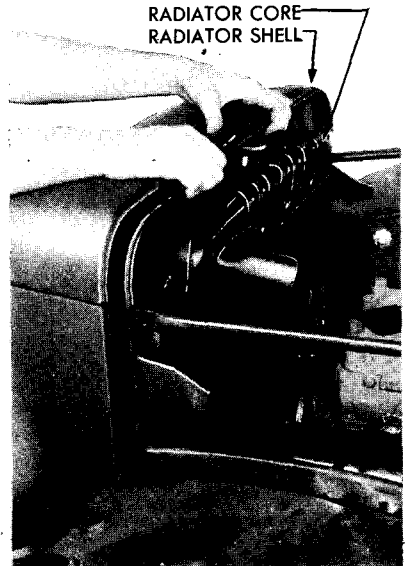

RA PD 52787

Figure 96—Installing Radiator Cap

Figure 97—Installing Radiator Core

86. RADIATOR.

a. **Radiator Cap.** Radiators of all vehicles covered by this manual are equipped with pressure control radiator caps. Very little loss of coolant will result if the normal operating temperature is not exceeded. The radiator cap is equipped with a spring-loaded valve that seals the overflow pipe opening from the radiator proper, when the correct cap is installed with the gasket in the radiator filler neck. The spring-loaded valve must be tight against the gasket to seal the cooling system. The valve in the cap remains on its seat until the pressure in the cooling system exceeds $1\frac{1}{2}$ to $2\frac{1}{2}$ pounds per square inch. Only when the pressure is great enough to raise the valve from its seat, can any vapor escape through the overflow from the cooling

3/4-TON 4 x 4 TRUCK (DODGE)

system. Whenever the cooling system is filled or a vehicle inspected, note the condition of the gasket and tighten cap securely. Replace the gasket whenever it becomes warped or when the valve is not making complete contact with the gasket.

b. Types of Filler Caps Used (fig. 95). Two types of pressure control caps have been used on vehicles covered by this manual. The correct type cap must be used to prevent loss of coolant. The first type pressure control cap has a measurement of $1\frac{1}{16}$ inches from the top of the cap engaging lugs to the bottom of the sealing flange that contacts the gasket in the radiator filler neck. The second type pressure control cap has a measurement of $\frac{1}{2}$ inch from the top of the cap engaging lugs to the bottom of the sealing flange that contacts the gasket in the radiator filler neck. **CAUTION:** *Other types of caps have been used on previous model vehicles. Do not attempt to use these on vehicles covered by this manual.*

c. Replacement of Cap (fig. 96). To replace the pressure control cap, grip the retainer in the filler neck with a pair of pliers, turn the retainer so that both ends will pass through the filler neck and lift out. It is not necessary to compress or bend the retainer to remove or install it.

d. Removal of Radiator Core (Vehicles without Fan Shroud).

- (1) DRAIN RADIATOR (par. 81).
- (2) REMOVE HOOD (par. 178).
- (3) REMOVE WATER PUMP ASSEMBLY (par. 85 a).
- (4) REMOVE RADIATOR CORE (fig. 97). Remove the six cap screws that hold the core to the support. Lift up on upper part of shell at filler neck hole to permit core filler neck to clear hole in shell, then push top of core toward engine and lift out.

e. Installation of Radiator Core (Vehicles without Fan Shroud).

(1) INSTALL RADIATOR CORE (fig. 97). Lower core between shell and engine, placing bottom of core in position, then lift up on upper part of shell at filler neck hole to permit core filler neck to clear hole in shell and pull top of core forward into place. Install three toothed lock washers and cap screws at each side of core.

- (2) INSTALL WATER PUMP ASSEMBLY (par. 85).
- (3) INSTALL HOOD (par. 178).

f. Removal of Radiator Core (Vehicles with Fan Shroud).

- (1) DRAIN RADIATOR (par. 81).
- (2) REMOVE HOOD (par. 178).
- (3) REMOVE FAN BLADES (par. 85 c (2)).
- (4) REMOVE RADIATOR CORE. Remove hose at top and bottom of radiator core. Disconnect both radiator tie rods at the radiator. Remove the six cap screws that hold the fan shroud and radiator core to the support and remove the shroud. Lift up on the upper part

COOLING SYSTEM

of shell at filler neck hole to permit core filler neck to clear hole in shell, then push top of core toward engine and lift out (fig. 97).

g. Installation of Radiator Core (Vehicles with Fan Shroud).

(1) **INSTALL RADIATOR CORE.** Lower core between shell and engine, placing bottom of core in position, then lift up on upper part of shell at filler neck hole to permit core filler neck to clear hole in shell and pull top of core forward into place (fig. 97). Install the fan shroud. Install three toothed lock washers and cap screws at each side of shroud and tighten shroud and core to support. Install hose at top and bottom of radiator. Connect left radiator tie rod.

(2) **INSTALL FAN BLADES** (par. 85 d (2)).

(3) **INSTALL HOOD** (par. 178).

(4) **FILL RADIATOR** (par. 81).

3/4-TON 4 x 4 TRUCK (DODGE)

Section XIX

BATTERY

	Paragraph
General description	87
Battery	88
Battery cables	89

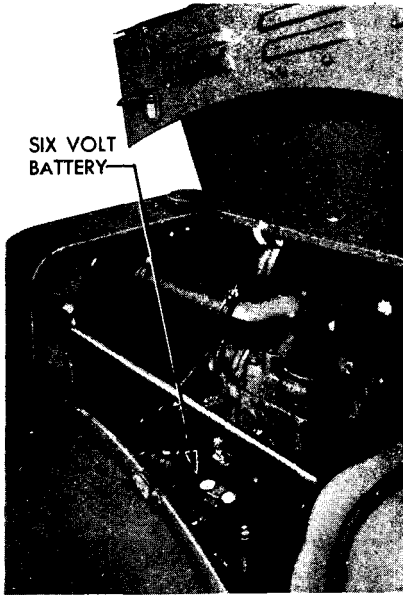

SIX VOLT

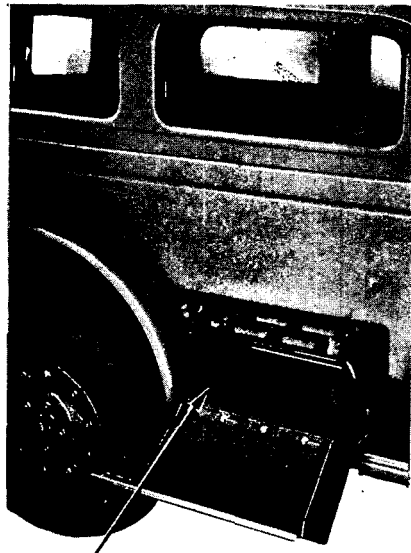

TWELVE VOLT

RA PD 58355

Figure 98—Battery Location

87. GENERAL DESCRIPTION.

a. The vehicles covered by this manual are equipped with either 6-volt or 12-volt batteries as listed below:

6-VOLT ELECTRICAL SYSTEM

Type of Vehicle	Model
Weapon carrier	WC-51
Weapon carrier with winch	WC-52
Ambulance	WC-54
Telephone maintenance ..	WC-59
Emergency repair	WC-60

12-VOLT ELECTRICAL SYSTEM

Type of Vehicle	Model
Carryall	WC-53
Command	WC-56
Command with winch ..	WC-57

BATTERY

b. Battery Location (fig. 98). The location of the battery offers a simple means of determining the voltage of the electrical system. On vehicles with 6-volt systems, the battery is located under the engine hood on the driver's side. On vehicles with 12-volt systems, the battery is mounted on the rear end of the running board on the side opposite the driver.

c. Data.

Battery capacity, ampere hour:

6-volt	116 (20 hr rate)
12-volt	204 (20 hr rate)
Battery terminal grounded	negative

88. BATTERY.

a. Battery Tests.

(1) **HYDROMETER TEST.** The following hydrometer readings show the charge condition of the battery:

Fully charged	1.275 to 1.300
Half charged	1.225
Dangerously low	1.150

(2) **SPECIFIC GRAVITY FOR HOT CLIMATES.** In hot climates (95°F and above), lower specific gravity electrolyte (1.245) is recommended to avoid excessive deterioration of plates and separators. When transferring batteries that have previously been in service in a temperate climate, to a tropical climate, first make sure the battery is fully charged. Then remove electrolyte to top of plates and fill with pure water. Charge the battery for two hours at 10 to 15 amperes and repeat procedure until a specific gravity of 1.245 is obtained.

(3) **VOLTAGE TEST.** To test the voltage output of the battery with a voltmeter, connect the positive lead from the voltmeter to the positive post of the battery and negative lead from the meter to the negative post of the battery. Read the voltage output on the voltmeter. A reading of 6.0 to 6.5 volts on a 6-volt battery or 12.0 to 13.5 volts on a 12-volt battery indicates normal voltage output.

b. Electrolyte Level. Add pure water to the battery as often as necessary to keep the battery plates covered with the electrolyte solution.

(1) **BATTERIES WITH VENT PLUGS.** Six-volt batteries and some 12-volt batteries are filled by removing the filler plugs and placing them over the vents. Fill each cell with pure water to top of filler opening. Then remove the filler caps from the vents and the electrolyte solution will drop to the proper level.

(2) **BATTERIES WITHOUT VENT PLUGS.** Twelve-volt batteries not equipped with vent plugs are filled by removing the filler plugs and adding sufficient pure water to each cell to bring the level of the electrolyte solution $\frac{3}{8}$ inch above the top of the battery plates.

3/4-TON 4 x 4 TRUCK (DODGE)

c. **Temperature at Which Battery Will Freeze.** A fully charged battery with a specific gravity of 1.260 to 1.300 will not freeze except in temperatures below -75°F but a discharged battery with specific gravity of 1.100 to 1.120 will freeze at 14°F to 18°F , above zero. For this reason, the battery should be kept fully charged when temperatures fall below freezing (32°F).

d. Removal of Battery.

(1) **DISCONNECT CABLES FROM BATTERY. CAUTION:** Always remove ground cable first.

(a) *Six-volt Battery.* Loosen terminal bolt nuts and lift terminals off battery posts.

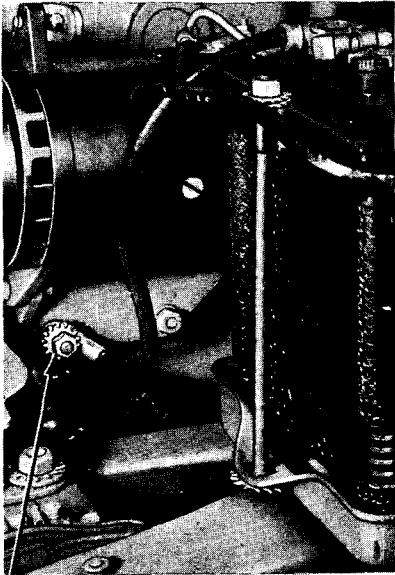

GROUND, MUST BE CLEAN AND TIGHT
SIX VOLT

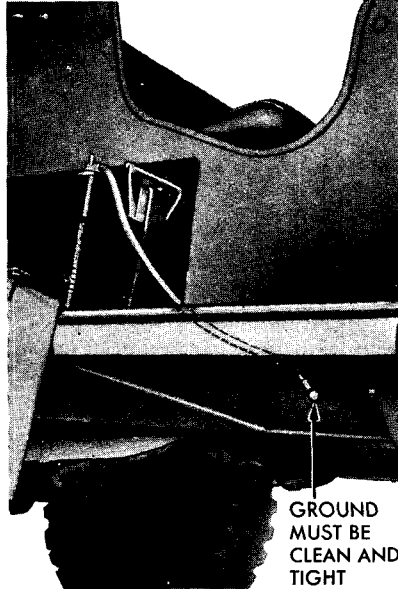

TWELVE VOLT

GROUND
MUST BE
CLEAN AND
TIGHT

RA PD 58360

Figure 99—Battery Ground (Negative) Cable

(b) *Twelve-volt Battery.* Remove two cap screws which hold battery cover in place and swing cover down. Then loosen battery terminal wing nut and lift off terminal.

(2) **REMOVE BATTERY FROM MOUNTING.** Remove two hold-down clamp bolt nuts, clamp or clamps. Then lift out battery.

e. Installation of Battery.

(1) **INSTALL BATTERY IN MOUNTING.**

(a) *Six-volt Battery.* Set battery in mounting with negative post forward and install hold-down clamp. Install toothed lock washer on front hold-down bolt and toothed lock washer on rear hold-down

BATTERY

bolt. Install generator wire bracket over front hold-down bolt with another toothed lock washer on top of bracket. Install and tighten nuts on both hold-down bolts.

(b) *Twelve-volt Battery.* Set battery in mounting with posts forward and install hold-down clamps. Install toothed lock washer on each hold-down clamp bolt. Then install and tighten nuts on both hold-down bolts.

(2) CONNECT BATTERY CABLES.

(a) *Six-volt Battery.* Lubricate terminals with a thin coating of chassis grease. Press terminals down on battery posts and tighten terminal bolt nuts.

(b) *Twelve-volt Battery.* Lubricate terminals with a thin coating of chassis grease. Install smaller single cable and longer one of pair of cables on negative terminal of battery. Install larger single cable and shorten one of pair of cables on positive terminal of battery. Then put wing nuts on battery terminal screws and tighten. Close battery cover. Install cap screws with toothed lock washer under the head of each cap screw and tighten cover.

89. BATTERY CABLES.

a. Removal of Battery Ground Cable.

(1) DISCONNECT CABLE FROM BATTERY (par. 88 d (1)).

(2) DISCONNECT GROUNDED END OF CABLE (fig. 99).

(a) *Six-volt Battery.* Remove nut from generator hinge bracket stud and remove cable.

(b) *Twelve-volt Battery.* Remove nut and bolt from frame side member and remove cable.

b. Installation of Battery Ground Cable (fig. 99).

(1) ATTACH GROUNDED END OF CABLE.

(a) *Six-volt Battery.* Install one toothed lock washer, then cable terminal on generator hinge bracket stud. Install another toothed lock washer and nut on stud and tighten securely.

(b) *Twelve-volt Battery.* Place one toothed lock washer on attaching bolt, then insert bolt through cable terminal and frame side member. Install another toothed lock washer and nut and tighten securely.

(2) CONNECT CABLE TO BATTERY (par. 88 e (2)).

c. Removal of Battery to Cranking Motor Cable.

(1) DISCONNECT CABLE FROM BATTERY (par. 88 d (1)).

(2) DISCONNECT CABLE FROM CRANKING MOTOR SWITCH. Remove nut from cranking motor switch terminal and lift off ammeter and radio interference wires and battery to cranking motor cable.

(3) DISCONNECT CLIPS WHICH HOLD CABLE TO CHASSIS (12-VOLT BATTERY ONLY). Remove clip on running board bracket. Open

3/4-TON 4 x 4 TRUCK (DODGE)

two clips on frame cross member over front of transfer case. Remove clip on frame cross member at rear of transmission. Open clip on engine crankcase and remove cable.

d. Installation of Battery to Cranking Motor Cable.

(1) **CONNECT CABLE TO CRANKING MOTOR SWITCH.** Place cable terminal on cranking motor switch with ammeter and interference filter wire terminals on top of cable terminal. Install standard lock washer and nut.

(2) **CONNECT CABLE TO BATTERY** (par. 88 e (2)).

(3) **CONNECT CLIPS WHICH HOLD CABLE TO CHASSIS (12-VOLT BATTERY ONLY).** Close clip on engine crankcase. Install clip on frame cross member at rear of transmission. Close two clips on frame cross member over front of transfer case. Install clip on running board bracket.

Section XX

STARTING SYSTEM

	Paragraph
General description	90
Cranking motor switch	91
Cranking motor pedal	92
Cranking motor	93

90. GENERAL DESCRIPTION.

a. The starting system (fig. 100) consists of the battery, the battery and ground cables, the cranking motor switch and the cranking motor. The starting system operates entirely independently of all other electrical equipment and wiring of the vehicle.

b. Two different types of cranking motors are used, depending on the voltage of the electrical system. The cranking motor used on vehicles with 12-volt electrical systems has a green plate with voltage shown on plate. Six-volt system cranking motors are equipped with a red plate showing the voltage.

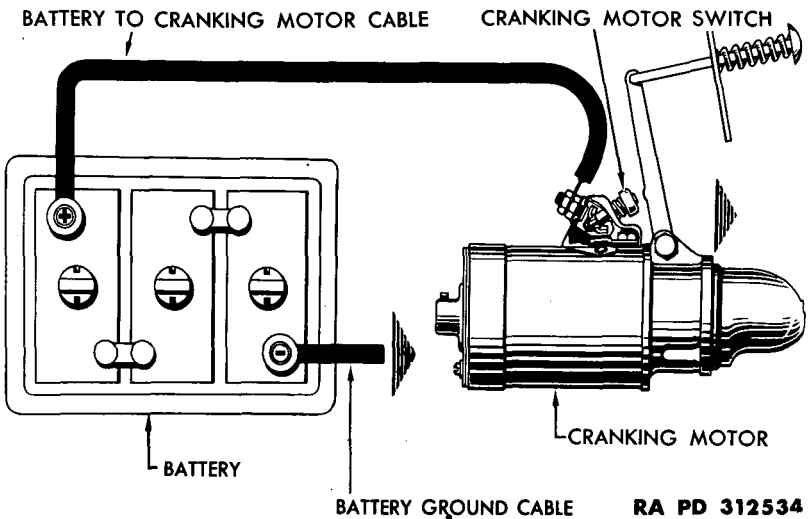

Figure 100—Cranking Circuit Diagram

91. CRANKING MOTOR SWITCH.

a. Removal.

- (1) DISCONNECT CABLE FROM BATTERY (par. 88 d).
- (2) REMOVE SWITCH. Remove terminal nut, ammeter, radio interference filter wires, and cable. Remove two screws which hold switch to cranking motor. Outside screw also holds radio interference filter in place.

3/4-TON 4 x 4 TRUCK (DODGE)

b. Installation.

(1) **INSTALL SWITCH.** Install screws which hold switch to cranking motor, place radio interference filter bracket under outer screw with a toothed lock washer under bracket and a toothed lock washer on top of bracket. Place cable, also ammeter and filter wire terminals, on post of switch and install standard lock washer and nut.

(2) **CONNECT CABLE TO BATTERY** (par. 88 e).

92. CRANKING MOTOR PEDAL.

a. Removal Procedure. Unscrew button from end of rod and spring will slip off. Disconnect rod from cranking motor switch lever and pull rod from front of dash.

b. Installation. Insert rod through dash from the front and connect to cranking motor switch lever. Place spring over rod and install button on end of rod.

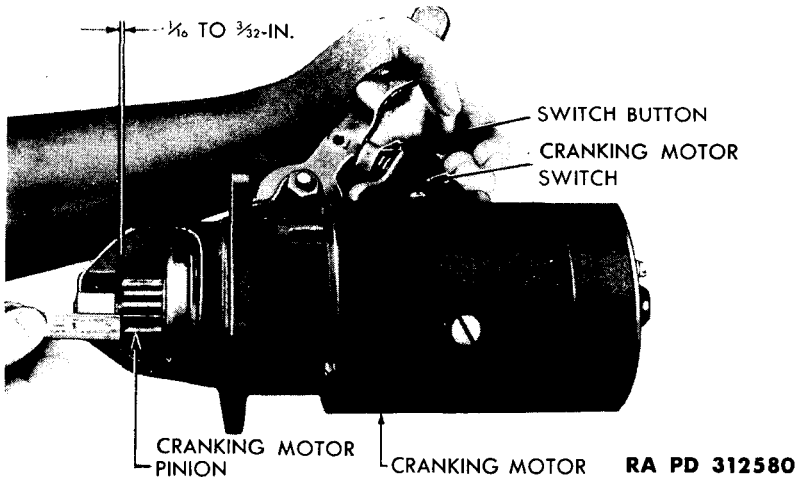

Figure 101—Checking Cranking Motor Pinion Clearance

93. CRANKING MOTOR.

a. Removal. Disconnect cable from battery to avoid damage from short circuit. Remove nut from switch and lift off radio filter wire, ammeter wire and battery cable. Disconnect wire running from radio filter to coil, at the coil. Remove two screws which hold switch and radio interference filter to cranking motor. Remove oil level indicator and disconnect lower end of oil filter to engine hose. Disconnect engine to oil gage tube and hose at engine and dash, and remove tube and hose. Disconnect cranking motor pedal rod at clevis. Remove two cap screws which hold cranking motor to clutch housing and lift out cranking motor.

STARTING SYSTEM**b. Installation.**

(1) **CHECK PINION CLEARANCE** (fig. 101). When the cranking motor pinion is fully engaged, there should be $\frac{1}{16}$ to $\frac{3}{32}$ inch clearance between the pinion and the pinion housing. Push the shift yoke assembly to its extreme limit of travel, or until the cranking motor switch has made contact. Then measure the clearance between the end of the pinion and the rear thrust washer. The cranking motor switch button may be screwed into or out of the switch assembly as required for proper pinion adjustment. **NOTE:** *Do not attempt to change the cranking motor switch button adjustment without removing the cranking motor to verify proper setting.*

(2) **INSTALL CRANKING MOTOR.** Place motor in clutch housing and install two cap screws which hold cranking motor in place. Connect pedal rod at clevis. Install engine to oil gage tube and hose. Connect lower end of oil filter to engine hose. Install oil level indicator. Install screws which hold switch to cranking motor. Place radio interference filter bracket under outer screw with toothed lock washer under bracket and toothed lock washer on top of bracket. Place cable, also ammeter and filter wire terminals, on post of switch and install standard lock washer and nut. Connect wire running from radio filter to coil at the coil. Connect cable to battery.

3/4-TON 4 x 4 TRUCK (DODGE)

Section XXI

GENERATING SYSTEM

	Paragraph
General description	94
Generator (6-volt)	95
Generator (12-volt)	96
Generator regulator	97

94. GENERAL DESCRIPTION.

a. **Types Used.** The vehicles covered by this manual are equipped with either a 6-volt or 12-volt generator. Six-volt generators can be identified by the red plate mounted on the generator. Twelve-volt

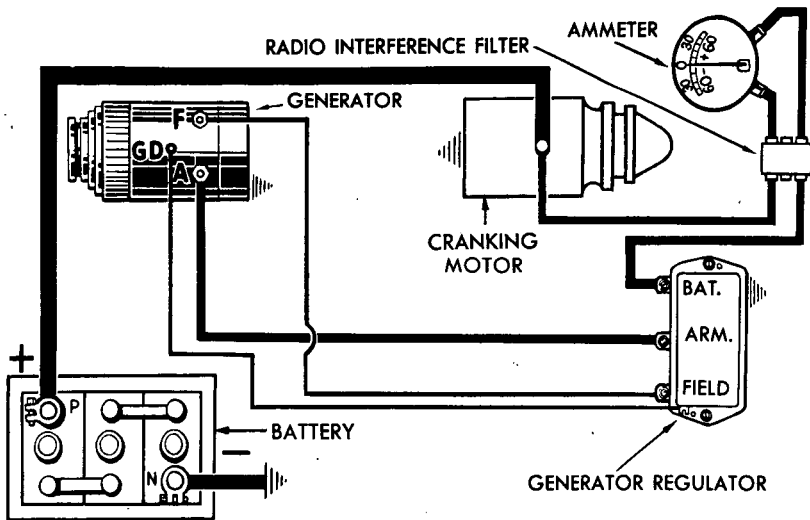

RA PD 312559

Figure 102—Generating Circuit Diagram

generators are equipped with a green plate. These plates show the model number, amperage, and voltage of the generator.

b. **Voltage Regulation.** The output of the generator is controlled in relation to the voltage requirements by the generator regulator, mounted on the engine side of the dash, keeping the battery fully charged and maintaining proper voltage under normal driving conditions. This means that the pointer of the ammeter mounted on the instrument panel of the vehicle may gradually approach zero, as the

GENERATING SYSTEM

battery becomes fully charged. This indicates that the generator output has dropped to a small sustaining charge necessary for a fully charged battery to prevent overcharge. The regulator contains three units, each performing a distinct and independent function. The three units of the regulator are known as the circuit breaker, the voltage regulator and the current regulator.

c. **Generating Circuit.** The generating circuit for both 6-volt and 12-volt vehicles is illustrated in figure 102.



Figure 103—Six-volt and Twelve-volt Generators

95. GENERATOR (6-VOLT).

a. **Removal** (fig. 103). Disconnect wires from generator. Remove wire bracket. Remove adjusting strap cap screw. Push generator toward engine and remove belt. Remove two generator hinge bolts and lift out generator.

b. **Installation.** (fig. 103).

(1) **INSTALL GENERATOR HINGE BOLTS.** Place generator in mounting bracket and install hinge bolts with standard lock washers and nuts, but do not tighten securely. See that mounting brackets, hinge bolts, and nuts are clean and free of grease, paint or rust, so that a good ground connection will be made at these points.

(2) **INSTALL FAN BELT AND CONNECT WIRES.** Install adjusting strap cap screw with plain washer and standard lock washer under

3/4-TON 4 x 4 TRUCK (DODGE)

head of cap screw. Do not tighten. Put belt in pulley and swing generator out to adjust belt (par. 82). When belt is adjusted tighten cap screw in strap and securely tighten nuts on hinge bolts. Connect wires to generator as shown in figure 103. Attach wire bracket to generator, placing one toothed lock washer under bracket and another toothed lock washer on top of bracket.

(3) **POLARIZE GENERATOR.** After installing the generator and before the engine is started, polarize the generator with the battery by momentarily connecting a jumper wire from the starting motor switch to the armature terminal (large terminal) on the generator.

96. GENERATOR (12-VOLT).

a. **Removal** (fig. 103). Disconnect wires from generator. Remove wire bracket. Remove adjusting strap bolt and loosen two hinge bolts. Push generator toward engine and remove belt. Remove two generator hinge bolts, and lift out generator.

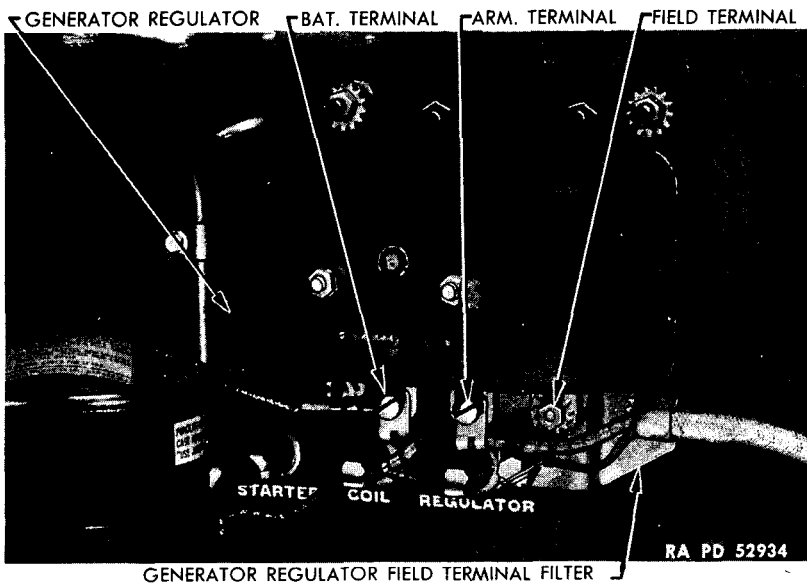

Figure 104—Generator Regulator

b. **Installation** (fig. 103).

(1) **INSTALL GENERATOR HINGE BOLTS.** Place generator in mounting bracket and install hinge bolts (from front). Insert front hinge bolt through support strap as well as bracket, install standard lock washers and nuts but do not tighten securely. See that mounting brackets, hinge bolts and nuts are clean and free of grease, rust or paint so that a good ground connection will be made at these points.

GENERATING SYSTEM

(2) **INSTALL FAN BELT AND CONNECT WIRES.** Install adjusting strap bolt and nut with one toothed lock washer under head of bolt and another toothed lock washer under nut. Do not tighten. Put belt in pulley and swing generator out to adjust belt (par. 82). When belt is adjusted, tighten bolt in strap. Securely tighten nuts on hinge bolts. Connect wires to generator as shown in figure 103, and attach wire bracket to generator, placing one toothed lock washer under bracket and another toothed lock washer on top of bracket.

(3) **POLARIZE GENERATOR** (par. 95 b (3)).

97. GENERATOR REGULATOR.

a. Removal (fig. 104). Disconnect cable from battery to avoid damage from short circuit. Disconnect wires and wire shielding bracket from regulator. Identify or tag four wires as they are removed to simplify installing in proper place. Remove attaching nuts and lock washers from four mounting studs and remove regulator from dash.

b. Installation (fig. 104). Place one toothed lock washer on each of the four mounting studs and push washers against dash. Install regulator assembly on mounting studs. Then place another toothed lock washer on each stud, install attaching nuts and tighten. Place attaching screw through wire shielding bracket, with a toothed lock washer above and below bracket. Attach bracket to regulator body and tighten screw. Connect four wires in proper places (fig. 104) with lock washers under heads of terminal screws. Connect cable to battery.

3/4-TON 4 x 4 TRUCK (DODGE)

Section XXII

IGNITION SYSTEM

	Paragraph
General description	98
Ignition timing	99
Spark plugs and cables	100
Distributor	101
Ignition coil and switch	102

98. GENERAL DESCRIPTION.

a. The ignition system contains the battery, distributor, ignition coil, spark plugs and necessary high- and low-tension wires, to com-

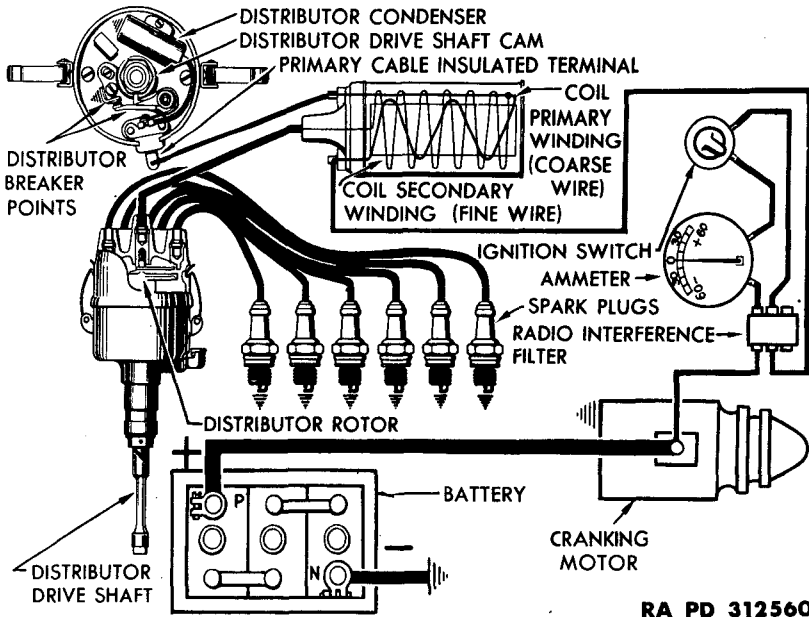

RA PD 312560

Figure 105—Ignition Circuit Diagram

plete the circuit for these units of the ignition system. The complete ignition circuit (fig. 105) consists of two separate circuits; the primary circuit and the secondary circuit. Briefly, these circuits function as follows:

(1) With the ignition switch turned on and the distributor breaker points closed, current flows through the primary winding of the ignition coil and builds up a strong magnetic field in the coil. When the breaker points open, the primary circuit is broken, collapsing the magnetic field and inducing a high voltage in the secondary

IGNITION SYSTEM

winding of the coil. This induced high voltage is distributed to the spark plugs by the distributor cap and rotor and the high-tension wiring between the distributor cap and spark plugs.

(2) To prevent arcing across the distributor breaker points as they open, a condenser is connected in parallel with the points. The purpose of the condenser is to provide a place for the primary current to flow until the points have separated far enough to prevent an arc across the points. The condenser brings the flow of current through the primary circuit to a quick stop. The quick stop of the current flow collapses the magnetic field and induces the high voltage necessary to provide a spark at the spark plug.



RA PD 52937

Figure 106—Checking Ignition Timing

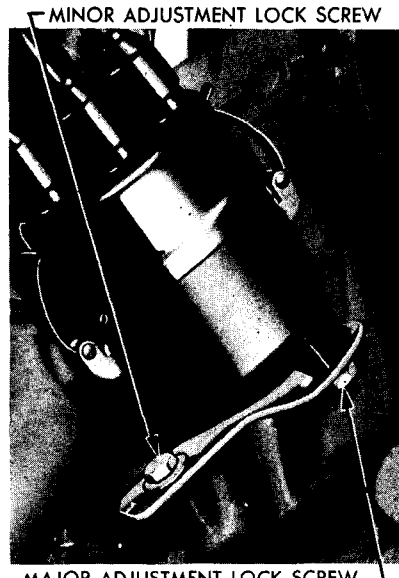

RA PD 52938

Figure 107—Ignition Timing Adjustments

b. Data.

Spark plugs:

Size	14 mm
Type	Auto-Lite A7 or A5
Gap	0.025 in.
Distributor breaker point gap	0.020 in.

99. IGNITION TIMING.

a. Timing Specifications.

(1) In low altitudes, gasoline of 70 octane rating will give best engine performance with timing set at two degrees after top dead

3/4-TON 4 x 4 TRUCK (DODGE)

center. With this timing, there will be a trace of spark ping from 10 to 30 miles per hour when accelerating with wide-open throttle.

(2) When using lower grade fuels, or after carbon has accumulated, spark ping may be excessive with the engine timed at two degrees after top dead center. In such cases, retard the timing not to exceed six degrees after top dead center.

(3) In high altitudes there is less tendency for spark ping, and the same thing is true in low altitudes when using fuel with a higher octane rating than 70. In such cases, improved performance may be obtained by advancing the spark not to exceed two degrees before top dead center.

(4) Within the foregoing limits, i.e., from two degrees before top dead center to six degrees after top dead center, a good rule to follow is to set the ignition timing at a point where a slight ping is audible when accelerating from 10 miles per hour with wide-open throttle.

b. Checking Timing with Timing Light.

(1) **CONNECT TIMING LIGHT** (fig. 106). Connect one lead from the timing light to a spark plug and the other lead to a convenient ground. Place a chalk mark on crankshaft pulley at two degrees after top dead center and run engine at idling speed. Point light at the chalk mark on the pulley. The neon light will flash when the chalk mark is opposite pointer over pulley, indicating position of piston when firing occurs.

(2) **ADJUST TIMING** (fig. 107). To advance or retard the timing, loosen the major adjustment lock screw and rotate distributor body until correct timing is obtained. To make a minor change in ignition timing, loosen the minor adjustment lock screw and rotate the distributor body slightly in the proper direction. Rotate distributor body clockwise to retard, and counterclockwise to advance ignition timing.

100. SPARK PLUGS AND CABLES.

a. Adjustment of Spark Plugs. Adjust spark plug gaps to 0.025 inch with a round feeler gage. Make all adjustments on the side wire of the plug. If the center electrode is bent, the porcelain may crack, resulting in plug failure.

b. Installation of Spark Plugs. Use a new gasket and tighten spark plugs with a torque-indicating wrench to 26 to 32 foot-pounds.

c. Removal of Spark Plug Cables. Unscrew suppressor from spark plug end of cable. Raise terminal nipple and pull cable out of distributor cap. Then pull cable through cable tube and nipple.

d. Installation of Spark Plug Cables. Slide terminal nipple, small end first, over lower end of cable, attach terminal to lower end of cable, then push cable through cable tube. Screw spark plug suppressor on upper end of wire. Connect suppressors to spark plugs and cables to distributor cap in the order shown in figure 117. Slide terminal nipples down over connections at distributor cap.

IGNITION SYSTEM

101. DISTRIBUTOR.

a. **Adjustment of Breaker Points** (fig. 108). Remove distributor cap and rotor and inspect points. If redressing is required, turn engine until points are closed. Open points with finger and place the contact point dresser between the points. Move the dresser back and forth until the points are clean and excessive roughness is removed. Turn the engine until distributor breaker point rubbing block is on a high point of distributor cam. Loosen the lock screw and turn adjusting screw until the gap between the breaker points is 0.020 inch. Tighten the lock screw and recheck the adjustment. Install distributor rotor and cap. Breaker points may be adjusted by the "cam angle" method if equipment is available. The cam angle is 38 degrees.

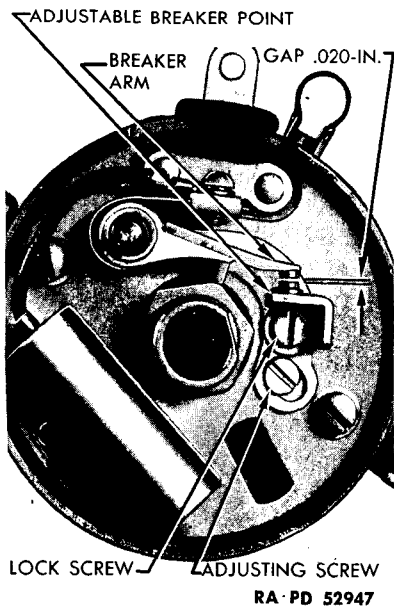

Figure 108—Distributor Breaker Point Adjustment

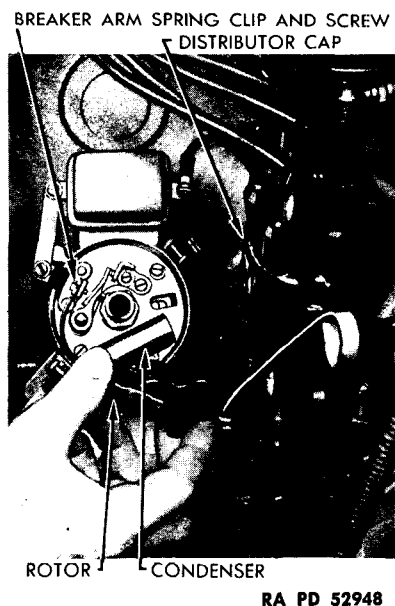

Figure 109—Distributor With Cap and Rotor Removed

b. **Removal of Breaker Points** (fig. 109). Remove the distributor cap and rotor. Remove the screw and clip which hold the condenser lead wire and breaker arm spring to the distributor plate and lift the breaker arm off its pivotal post. Remove the breaker point lock screw and lift off the breaker point plate.

c. **Installation of Breaker Points** (fig. 108).

(1) **INSTALL BREAKER POINTS.** Place the breaker point plate over the adjusting screw and install lock screw. Place breaker arm over pivotal post and install screw which holds breaker arm spring and

3/4-TON 4 x 4 TRUCK (DODGE)

condenser lead wire to distributor plate. Put one drop of engine oil on pivotal post.

(2) **ADJUST BREAKER POINTS** (subpar. a above).

(3) **ADJUST BREAKER ARM SPRING TENSION.** Turn the engine until the breaker points are closed. Hook a spring scale to the point end of the breaker arm and hold the scale at right angle to the point surfaces. Pull the breaker points open with the scale. Adjust by loosening the screw holding the end of the breaker point spring and slide the end of the spring in or out of the clip so that 18 to 20 ounce pull will be required to open the breaker points. When spring tension has been properly adjusted, tighten screw securely and install distributor rotor and cap.

(4) **ADJUST IGNITION TIMING** (par. 99).

d. Removal of Distributor Cap. Slide the terminal nipples up the spark plug and coil cables. Pull the cables out of the distributor cap. Unlatch the two distributor cap hold-down springs and lift off the distributor cap.

e. Installation of Distributor Cap. Place distributor cap on distributor body making sure that the section of the cap which is not bored out like the rest of the opening, registers with the notch in the top of the distributor body. Latch the two distributor cap hold-down springs. Place the terminal nipples on each cable and connect the spark plug cables. Connect the cable from the coil to center of distributor and move the terminal nipple down over connection.

f. Removal of Distributor Rotor. Unlatch the two distributor cap hold-down springs and lift distributor cap and cable assembly off distributor. Lift rotor straight off distributor drive shaft.

g. Installation of Distributor Rotor. Place rotor over distributor drive shaft with flat in bore of rotor registering with flat on distributor drive shaft and push rotor into place. Place cap on distributor body so that notches register, and latch the two cap hold-down springs.

h. Removal of Condenser. Unlatch the two distributor cap hold-down springs and lift off distributor cap and cable assembly. Lift rotor straight off distributor shaft. Disconnect condenser lead wire and remove screw which holds condenser to distributor plate.

i. Installation of Condenser. Install condenser mounting screw and connect lead wire to distributor plate. Adjust distributor breaker arm spring tension (subpar. c (3) above). Install distributor cap and cable assembly.

j. Removal of Distributor Assembly. Slide terminal nipples up spark plug to coil cables, and pull cables out of distributor cap. Disconnect wire which runs from coil to distributor filter at the filter. Remove distributor lock plate hold-down cap screw and lift distributor out.

IGNITION SYSTEM

k. Installation Procedure.

(1) **SET CRANKSHAFT IN PROPER POSITION** (fig. 110). Crank engine by hand and check for compression on number one cylinder. Hold thumb over spark plug hole while cranking or use compression gage. When compression is indicated, turn crank until "DC" mark on fan drive pulley registers with the pointer on the chain case. Number one piston will then be at the top of its firing stroke.

(2) **INSTALL DISTRIBUTOR** (fig. 111). Place distributor in position with lock plate over hold-down screw hole. Remove distributor cap and turn rotor until it points to about seven o'clock, then push distributor assembly down and move rotor back and forth slightly to

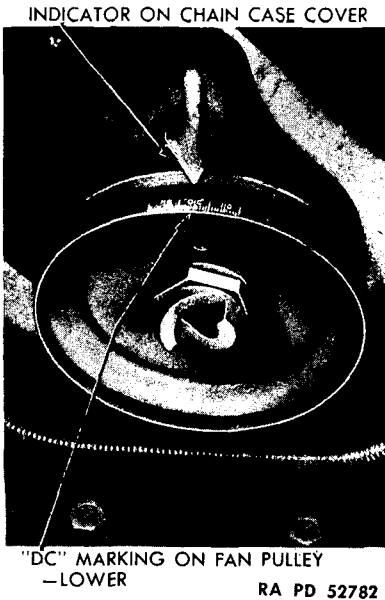

Figure 110—Timing Mark Location

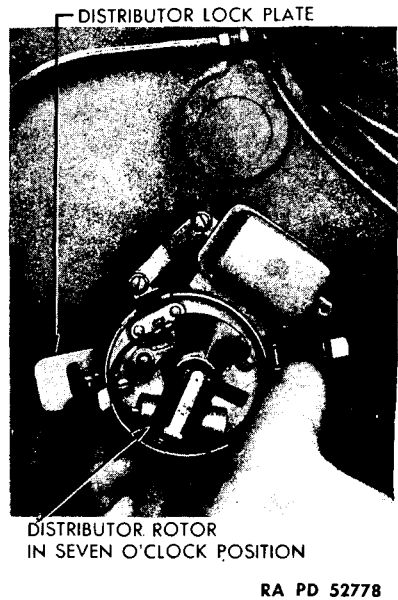

Figure 111—Installing Distributor

allow tongue on distributor shaft to engage in slot of oil pump drive shaft. Install lock plate hold-down cap screw with a toothed lock washer under head of screw. Connect coil wire to distributor filter.

- (3) **INSTALL DISTRIBUTOR CAP AND CABLES** (subpar. e above).
- (4) **ADJUST IGNITION TIMING** (par. 99).

102. IGNITION COIL AND SWITCH.

a. **Removal of Coil.** Disconnect, at the coil, wires which run from filters at the dash and distributor. Disconnect the ground strap from upper end of coil. Pull cable out of lower end of coil. Remove two nuts which hold coil to mounting bracket studs.

3/4-TON 4 x 4 TRUCK (DODGE)

b. Installation of Coil. The voltage capacity of coil is shown on the coil body. **CAUTION:** *Be sure capacity of coil is correct for electrical system of vehicle.*

(1) **MOUNT COIL ON BRACKET.** Place coil on mounting bracket studs and install the nuts with wire clip and standard lock washer under nut on the outer stud and standard lock washer under nut on the inner stud.

(2) **CONNECT WIRES AND GROUND STRAP.** Push cable which runs to center of distributor cap into lower end of coil. Connect ground strap to post at upper end of coil, placing toothed lock washer between coil and strap and another toothed lock washer between strap and nut. Connect wire which runs from filter at distributor to inner post at lower end of coil, placing standard lock washer under nut. Place wire which runs from filter on dash in clip at coil mounting stud and close the clip. Then connect that wire to outer post at lower end of coil, placing standard lock washer under nut.

c. Removal of Switch. Unscrew switch mounting nut on face of instrument panel using screwdriver as drift to loosen ring. Disconnect wire from switch.

d. Installation of Switch. Connect single wire from ammeter to left post of switch with standard lock washer under nut. Connect two wires, one which runs to radio interference filter on dash and one which runs to fuel gage, to right post of switch (nearest throttle control button), placing standard lock washer under nut. Place switch in instrument panel so that small lip on switch body enters notch in panel. Screw mounting nut onto switch body, using screwdriver as drift to tighten ring.

Section XXIII

RADIO INTERFERENCE SUPPRESSION

Paragraph

Radio interference suppression 103

103. RADIO INTERFERENCE SUPPRESSION.

a. General. When the engine of a vehicle is running, the electrical system of that vehicle is a source of radio interference; it is actually broadcasting radio waves in various frequencies and wave form that interfere with the radio receiving equipment in that vehicle as well as in nearby radio-equipped vehicles or signal apparatus. In order to reduce such interference, vehicles covered by this manual are equipped with a suppression system consisting of various types of suppression units incorporated throughout the vehicle. These units are described in the following steps:

(1) **RESISTOR-SUPPRESSORS** (fig. 112). The resistor-suppressor is a high resistant element designed to suppress ignition noise. It is mounted securely in an insulated housing having accessible electrical connections in both ends. Seven resistor-suppressors are installed in the ignition circuit. Six are installed on the spark plug wires (one at each plug) and one is installed in the high tension wire (center terminal) two inches from the distributor cap.

(2) **FILTERS AND CONDENSERS** (fig. 112). The purpose of the filters and condensers is to decrease interferences set up by the ignition and electrical systems. Three filters are mounted in a metal housing, located on the left side of the dash above the clutch and brake pedals. The housing is mounted with cadmium plated bolts and nuts and toothed lock washers in direct contact with the metal of the dash. These three filters are connected in the circuit as follows:

(a) One filter (Signal Corps Type FL-12 or 19) is located in generator regulator battery B terminal lead to ammeter.

(b) One filter (Signal Corps Type FL-12 or 19) is located in the ammeter lead to cranking motor terminal.

(c) One filter (Signal Corps Type FL-14 or 19) is located in the ignition switch to coil primary circuit.

Additional filters are located as follows:

(d) One filter (Signal Corps Type FL-13) is connected in the generator field lead to regulator at the regulator.

(e) On early model vehicles, one distributor filter (Signal Corps Type FL-15) is mounted on the side of the distributor housing and is connected in series with the coil primary distributor lead.

(f) One condenser (0.5 microfarad) is connected to the positive battery terminal (12-volt battery-reconnaissance only).

(g) One condenser (0.5 microfarad) is connected from the crank- ing motor frame to the switch terminal.

(h) One condenser (0.5 microfarad) is connected in the radio terminal box (on Carryall only).

3/4-TON 4 x 4 TRUCK (DODGE)

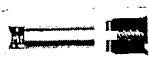

RESISTOR—SUPPRESSORS

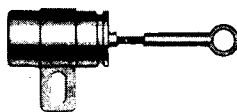

CONDENSER

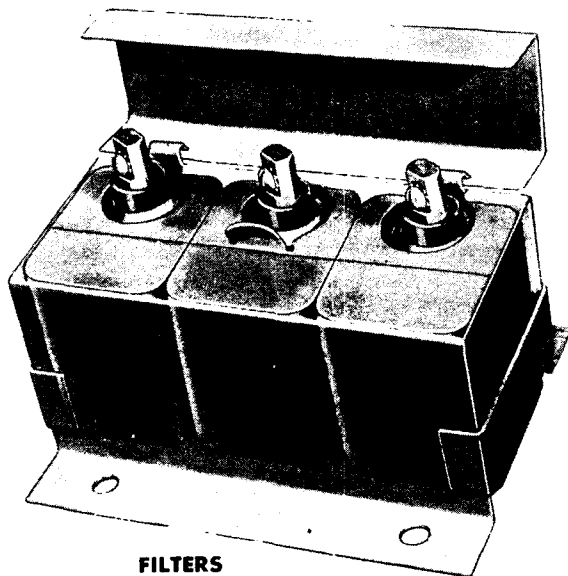

FILTERS



SHIELDING



BONDING (GROUND STRAP)

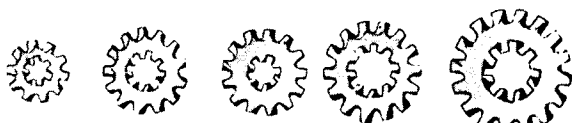

INTERNAL-EXTERNAL TEETH LOCK WASHERS

RA PD 312569

Figure 112—Radio Interference Suppression Components

RADIO INTERFERENCE SUPPRESSION

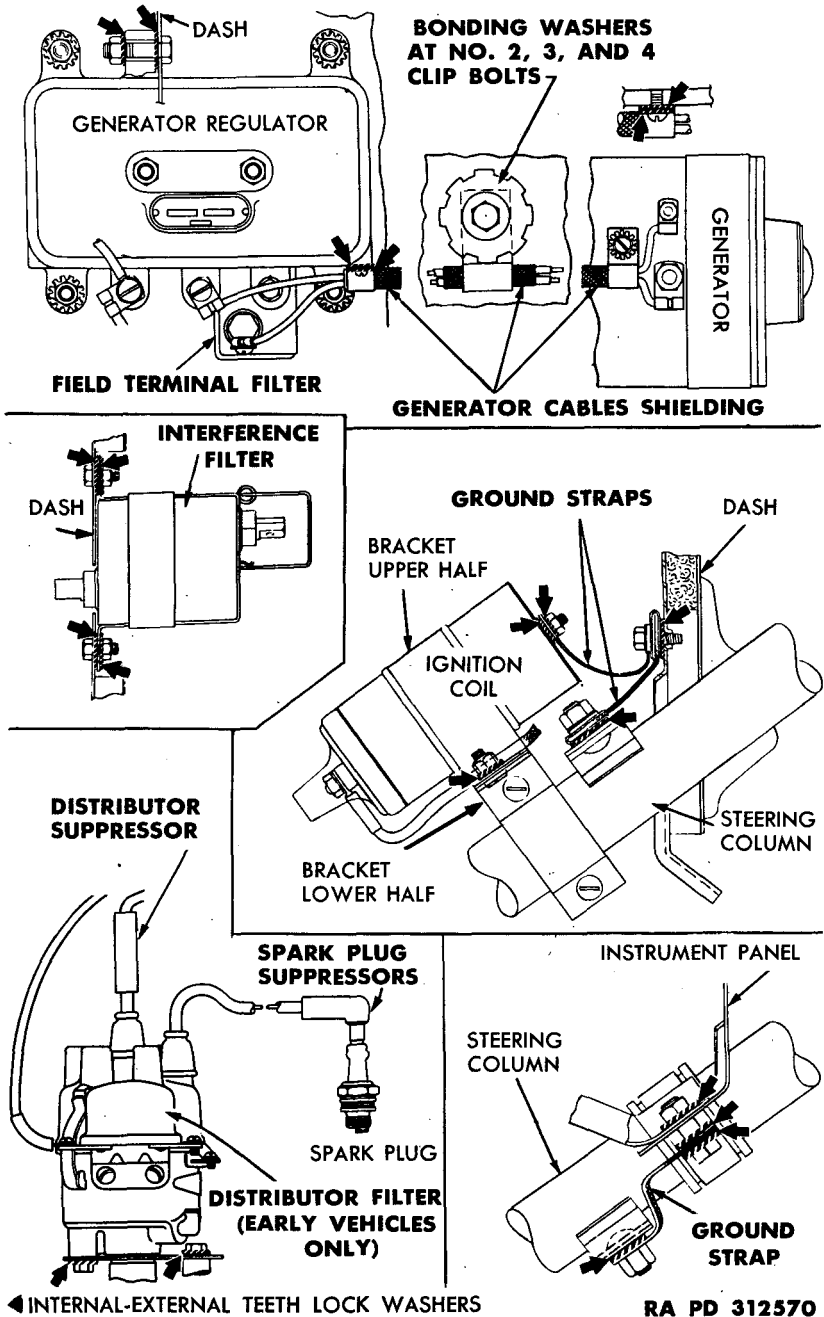
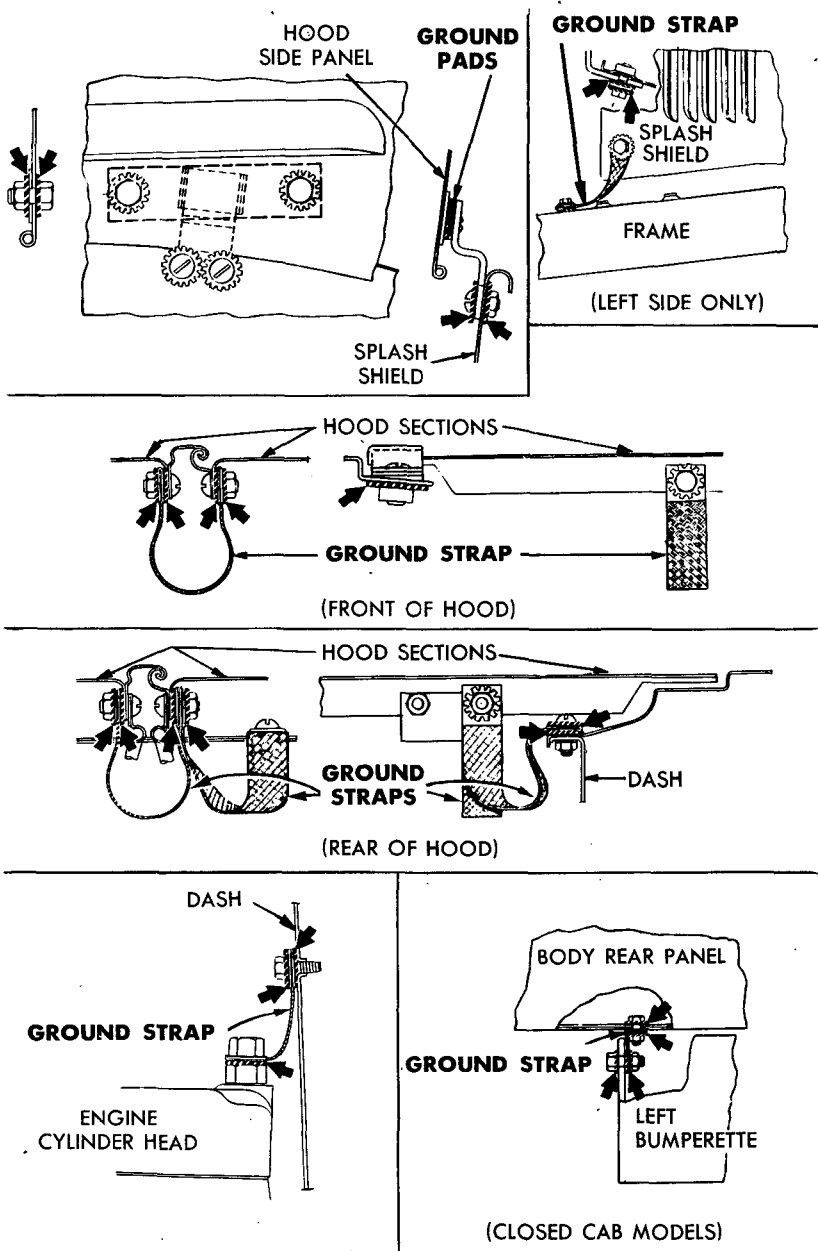

Figure 113—Location of Radio Interference Suppression Bonds

3/4-TON 4 x 4 TRUCK (DODGE)



◀ INTERNAL-EXTERNAL TEETH LOCK WASHERS

RA PD 312571

Figure 114—Location of Radio Interference Suppression Bonds

RADIO INTERFERENCE SUPPRESSION

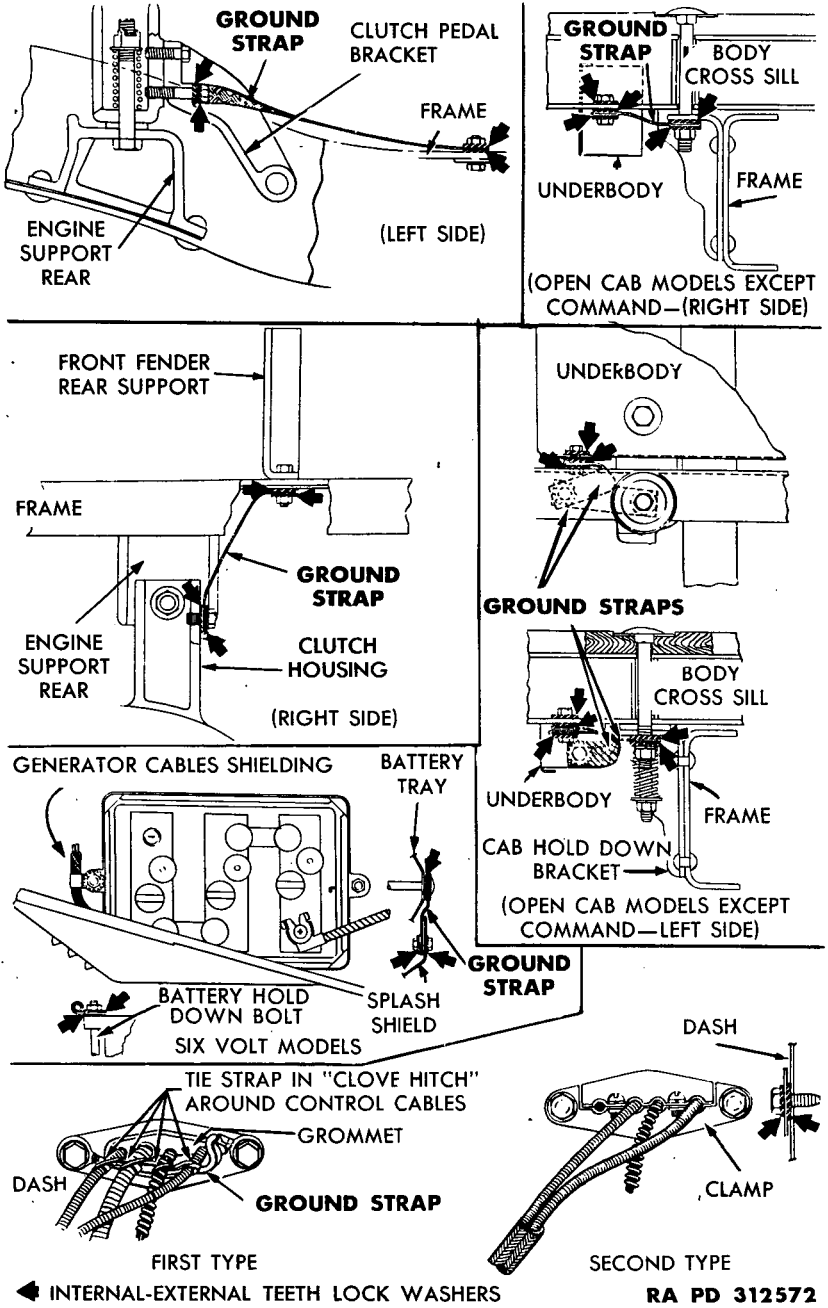
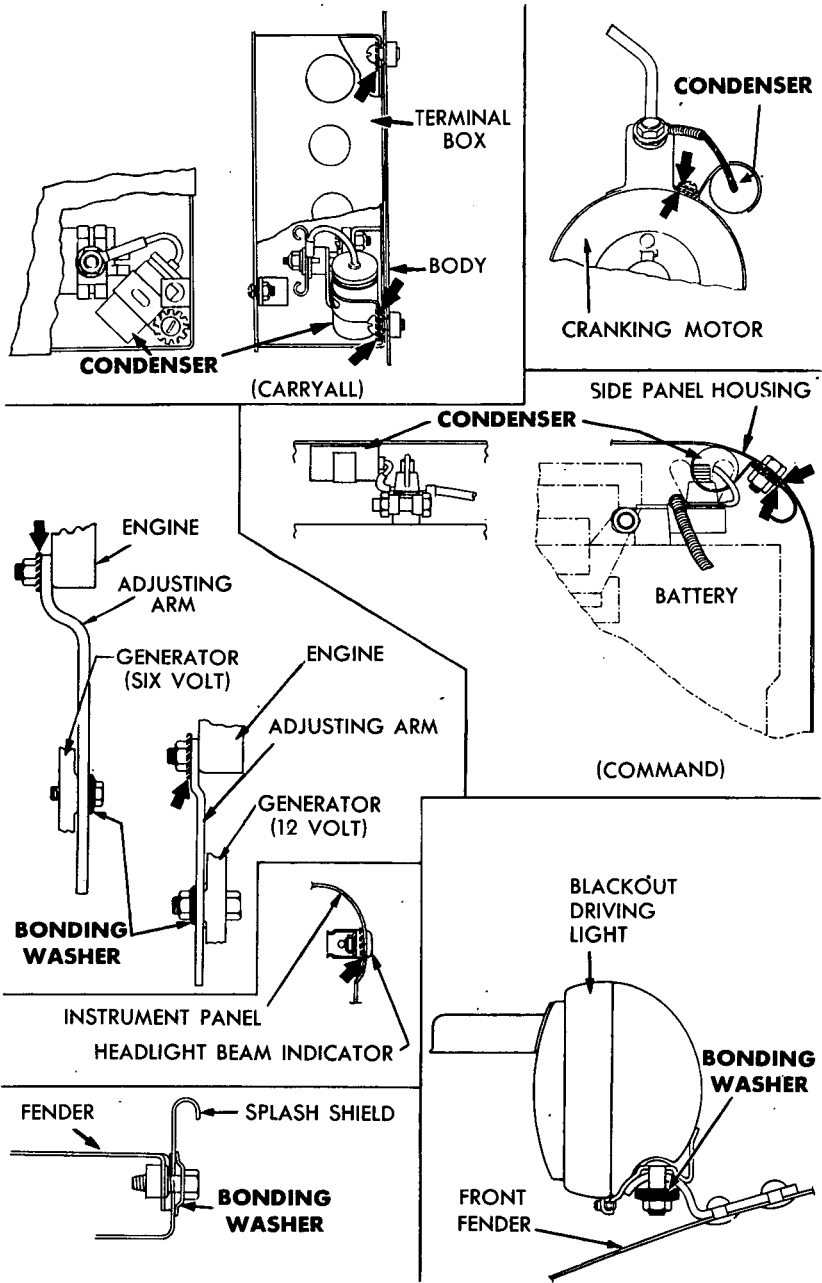

Figure 115—Location of Radio Interference Suppression Bonds

3/4-TON 4 x 4 TRUCK (DODGE)



◀ INTERNAL-EXTERNAL TEETH LOCK WASHERS

RA PD 312573

Figure 116—Location of Radio Interference Suppression Bonds

RADIO INTERFERENCE SUPPRESSION

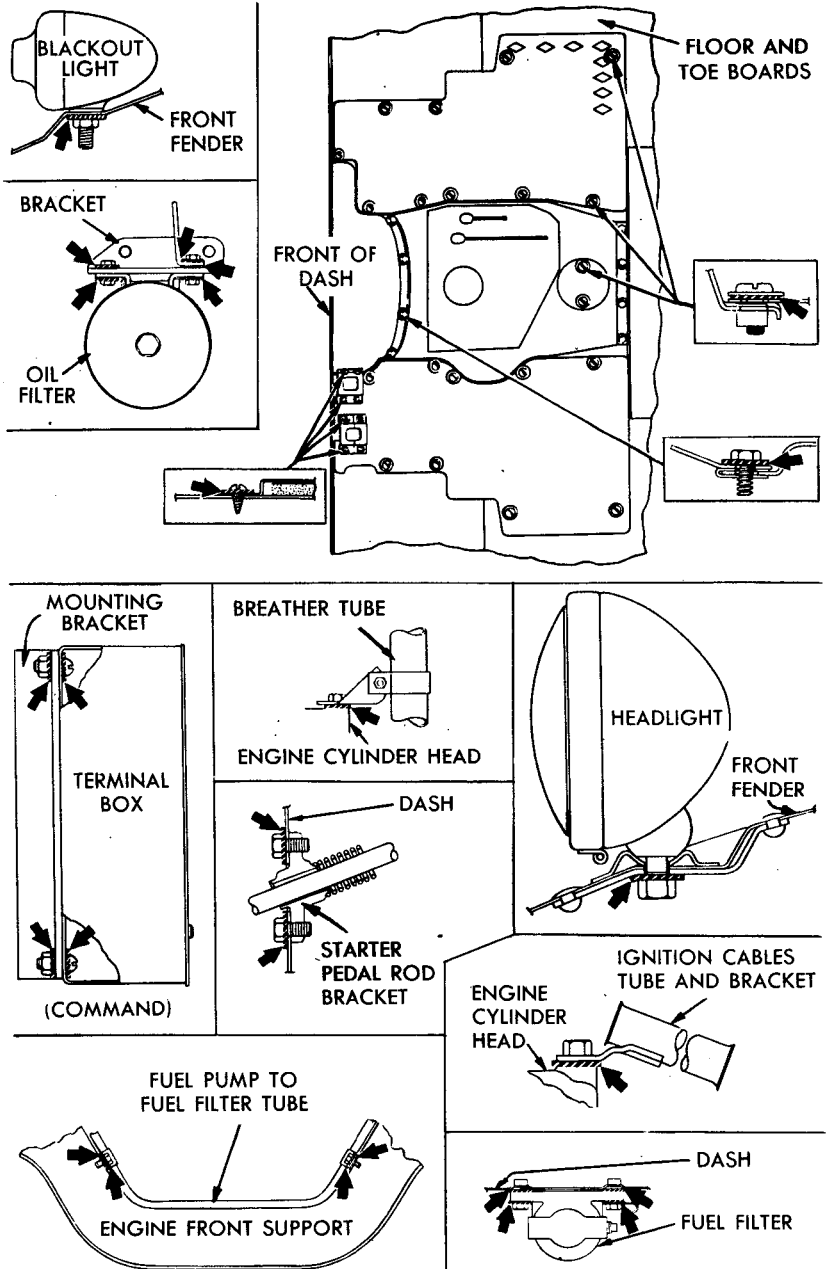

◀ INTERNAL-EXTERNAL TEETH LOCK WASHERS

RA PD 312574

Figure 117—Location of Radio Interference Suppression Bonds

3/4-TON 4 x 4 TRUCK (DODGE)

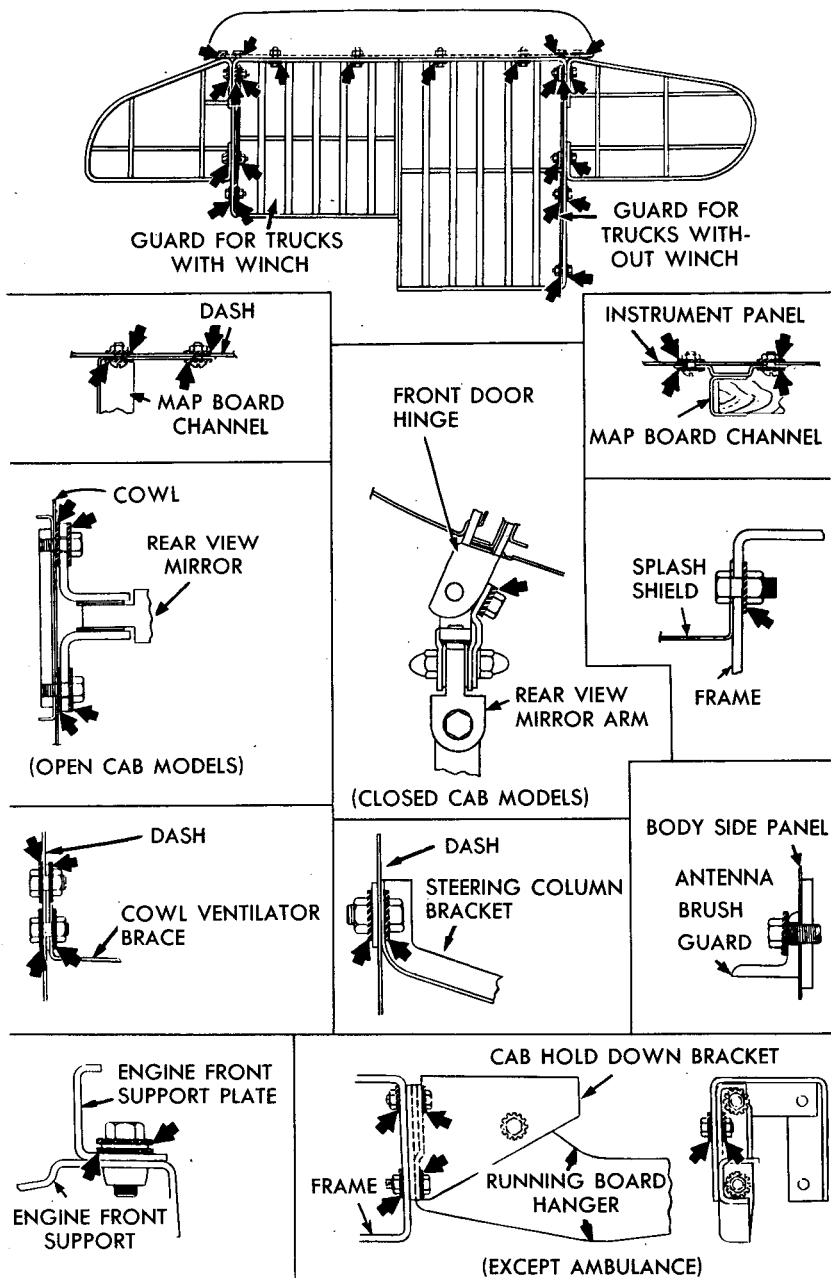

◀ INTERNAL-EXTERNAL TEETH LOCK WASHERS

RA PD 312575

Figure 118—Location of Radio Interference Suppression Bonds

RADIO INTERFERENCE SUPPRESSION

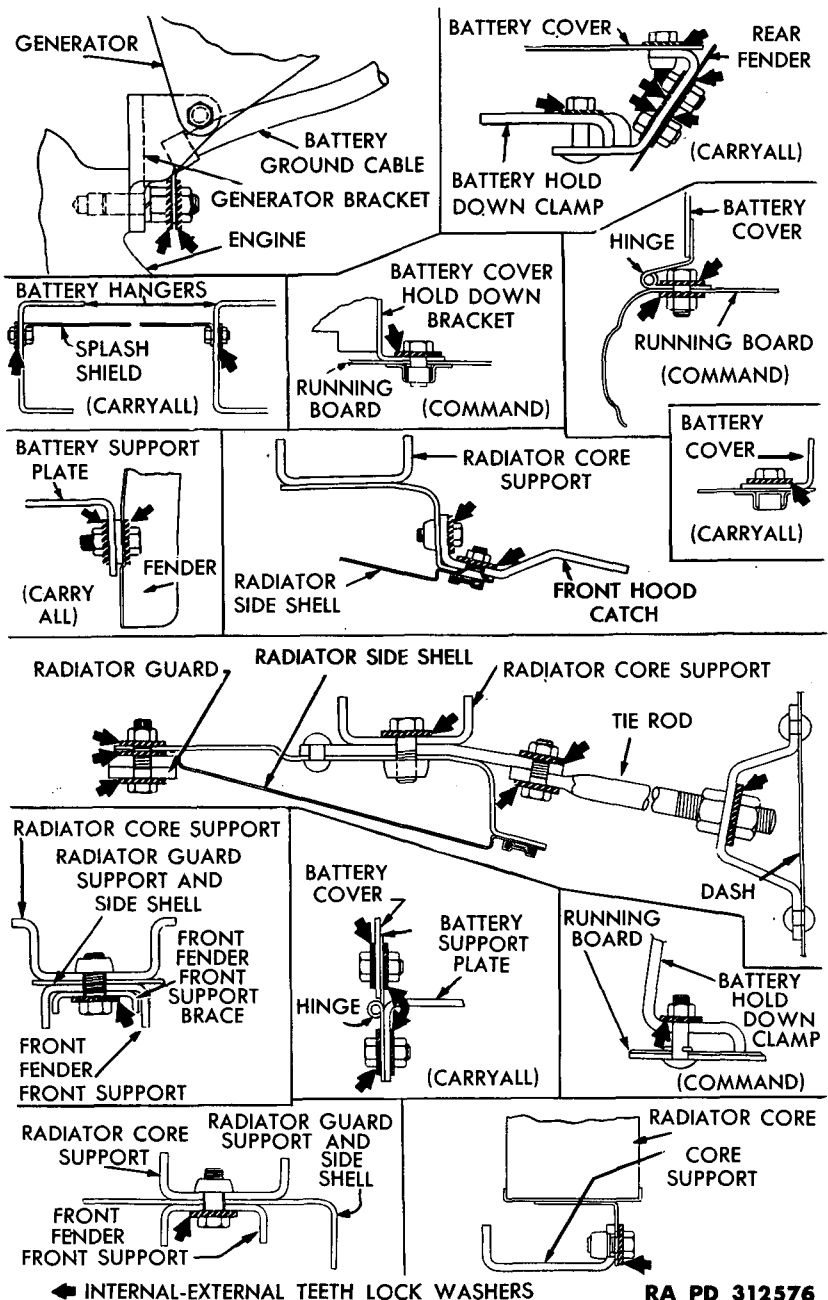
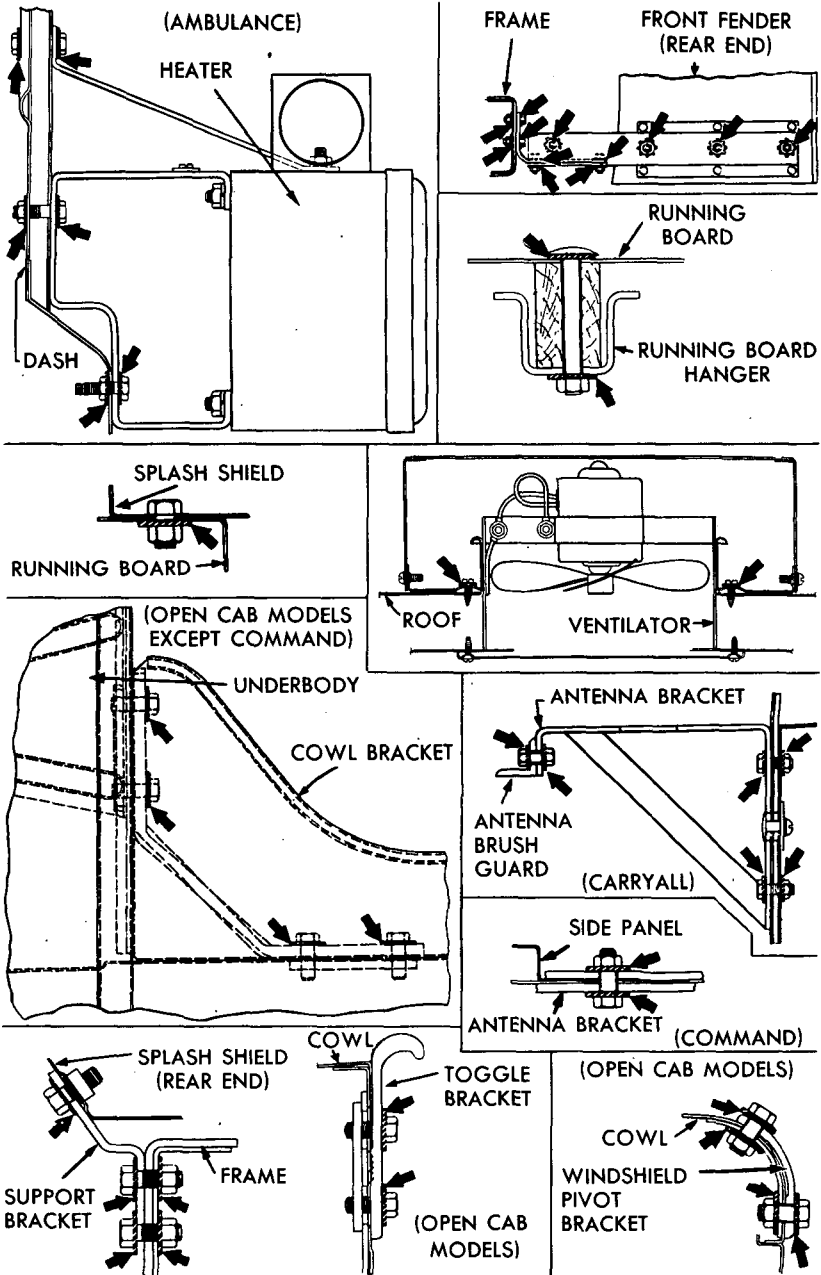

Figure 119—Location of Radio Interference Suppression Bonds

3/4-TON 4 x 4 TRUCK (DODGE)



← INTERNAL-EXTERNAL TEETH LOCK WASHERS

RA PD 312577

Figure 120—Location of Radio Interference Suppression Bonds

RADIO INTERFERENCE SUPPRESSION

(3) **SHIELDING** (fig. 112). Shielding is accomplished by encasing wires of the electrical system in a metal braid and grounding the braid at both ends to keep the wires and braid from radiating interference.

(4) **BONDING** (fig. 112). Bonding is an electrical contact of extremely low resistance, between two or more metal parts. Various points of the vehicle are bonded by means of tinned copper braid ground straps. These straps are fastened to their respective points by cadmium plated bolts and nuts or screws and toothed lock washers. Fenders, shields and other sheet metal parts are fastened together by means of cadmium plated fastening bolts and toothed lock washers; these lock washers when drawn up tight "bite" into the metal surfaces which they contact and form a good ground.

b. Servicing and Replacing Bonded Parts (figs. 113 through 120). Before replacing bonded parts, clean off all paint and dirt from the mounting surfaces, tops and bottoms of both ends of bonds and their placement position on the vehicle. Replace any broken or frayed bonds. Exercise special care when replacing bonded parts to be sure they are installed in exactly the same manner as they were assembled before removal. Install toothed lock washers in their original sequence and draw up mounting bolts very tight to form a good ground. All important points of bonding are illustrated in figures 113 through 120.

3/4-TON 4 x 4 TRUCK (DODGE)

Section XXIV

LIGHTING SYSTEM

	Paragraph
General description	104
Headlights	105
Headlight beam indicator and switch	106
Blackout parking lights	107
Blackout driving light and switch	108
Tail and stop lights	109
Instrument lights and switch	110
Dome lights	111
Spotlight (Ambulance)	112
Main lighting and blackout switch	113

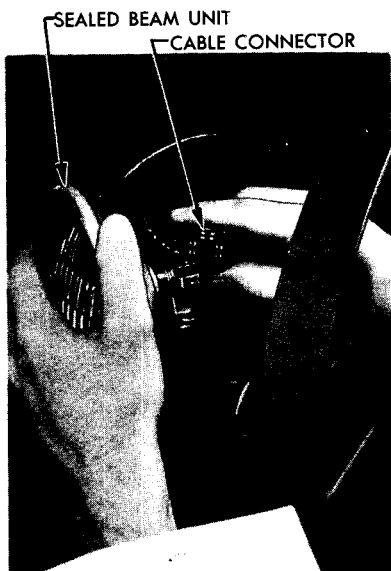

RA PD 52954

Figure 121—Installing Right Headlight Sealed Beam Unit

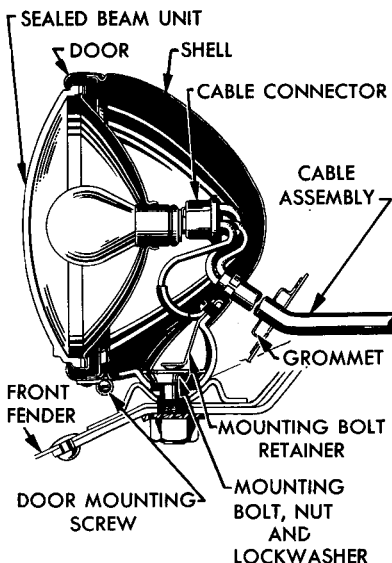

RA PD 52953

Figure 122—Headlight Assembly

104. GENERAL DESCRIPTION.

a. All lights, except the Ambulance dome light, operate through the main lighting and blackout switch (fig. 127). A circuit breaker mounted on the switch protects the lighting system against damage caused by short circuits. The circuit breaker automatically opens the circuit if any light wire becomes grounded.

LIGHTING SYSTEM**105. HEADLIGHTS.**

a. Removal of Sealed Beam Lamp-unit (fig. 121). Remove the headlight door. Lift out the sealed beam unit and pull the cable connector straight off. When removing the sealed beam unit in the right headlight, loosen the mounting bolt nut and turn the headlight away from the radiator to make the mounting screw in the door accessible.

b. Installation of Sealed Beam Lamp-unit (fig. 121). Hold the sealed beam lamp-unit with the word "TOP" (on the lens) up and push the cable connector over the prongs on the lamp-unit. Place the unit in the headlight shell so that the long lug on the unit registers with the notch at the right side of the body. Install the headlight door and the mounting screw at the bottom. If the sealed beam unit has been replaced in the right headlight, turn it back into position, aim the light (subpar. e below) and tighten mounting bolt nuts.

c. Removal and Disassembly of Headlight (fig. 122).

(1) **REMOVE HEADLIGHT AND SEALED BEAM UNIT.** Remove nut from headlight mounting bolt and lift headlight off the fender. Remove the door. Pull the cable connector straight off the three prongs of the sealed beam unit.

(2) **DISCONNECT AND REMOVE WIRE ASSEMBLY.** Remove two screws which attach wire grommet to the fender and open clip which holds cable assembly to the radiator shell. Disconnect the two wires from the terminal block on frame front cross member. Pull cable assembly up through the fender and slip the grommet off the wire. Disconnect ground wire and retainer from the headlight body and pull the cable assembly out of the back of the light body.

d. Assembly and Installation of Headlight (fig. 122).

(1) **INSTALL AND CONNECT WIRE ASSEMBLY.** Put the two wires and loom through hole in headlight body and connect the ground wire and retainer to the headlight body. Slide the wire grommet over the cable assembly. Then thread the wires down through the fender and clip on the radiator shell and connect each wire to the terminal block that carries the same color wire at the terminal block on the frame. Install a standard lock washer under each nut and tighten. Close wire clip and attach grommet to fender.

(2) **INSTALL SEALED BEAM UNIT AND HEADLIGHT.** Hold the sealed beam unit with the word "TOP" (on the lens) up and push the cable connector over the prongs on the unit. Place the unit in the headlight so that the long lug on the unit registers with the notch at the right side of the body. Install the headlight door and mounting screw at bottom of the door. Place headlight mounting bolt through plate and fender and install toothed lock washer and nut.

(3) **AIM HEADLIGHTS** (subpar. e below).

3/4-TON 4 x 4 TRUCK (DODGE)

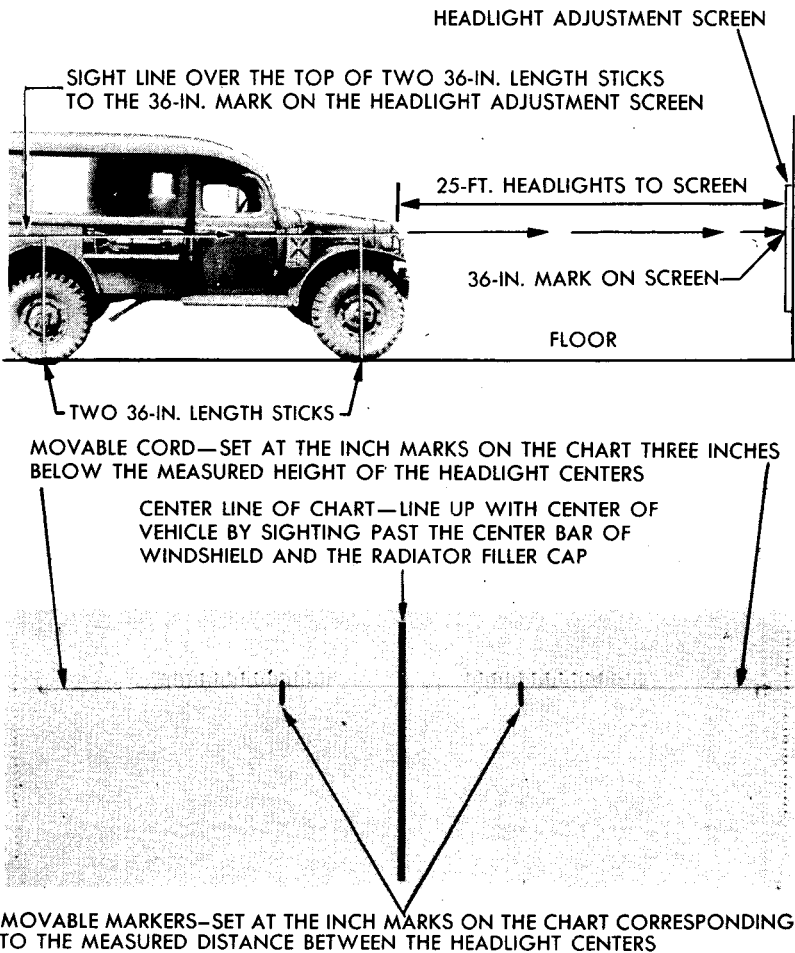

RA PD 312539

Figure 123—Headlight Aiming

e. Headlight Aiming (fig. 123).

(1) **PREPARE VEHICLE AND SCREEN FOR AIMING.** Inflate all tires on vehicle to 40 pounds pressure. Mount the headlight screen on a movable frame and draw the screen taut on the frame. Place the vehicle on the most level floor or surface available.

(2) **LOCATE AND CENTER SCREEN.** Hang or locate the screen at right angles to the vehicle exactly 25 feet ahead of the headlights. Move the screen so that the heavy vertical line on the screen is directly in line with center line of the vehicle. Sight past the center

LIGHTING SYSTEM

bar of the windshield and the radiator filler cap to establish alinement.

(3) **LEVEL SCREEN.** Stand two sticks, 36 inches long, at the front and rear wheels on one side of the vehicle. Sight over the two sticks and adjust the screen vertically so that the 36-inch mark on the screen is on a line with the top of the two sticks. Repeat the operation on the other side of the vehicle.

(4) **LOCATE CORRECT HEADLIGHT POSITION ON SCREEN.** Measure the distance from the center of the headlights to the floor and hook the cord to both ends of the screen at the inch marks three inches below the measured height of the headlight centers. Do not measure height from floor to cord. Measure the distance between the headlight centers and slide the two vertical markers on the horizontal cord to the inch marks on the screen corresponding to the measured distance between the headlight centers.

(5) **AIM HEADLIGHTS.** Loosen headlight mounting bolt nut and turn on the headlight bright beam. Cover one light and aim the other so that the center of zone of highest intensity falls on the screen at the intersection of the horizontal cord and the vertical marker directly in front of the light. Tighten the headlight mounting bolt nut securely and aim the other light in the same manner.

106. HEADLIGHT BEAM INDICATOR AND SWITCH.

a. **Replacement of Lamp.** Pull the socket and lamp forward and off the body. Turn lamp counterclockwise and pull it from socket. To install, push lamp into the socket and turn in clockwise. Push the socket into the body.

b. **Removal of Headlight Beam Indicator Assembly.** Remove lamp (subpar. a above). Push the socket up the wire and pull the small tip off the wire. Then slide fiber insulator, spring and socket off the wire. Unscrew the body from light outlet in instrument panel.

c. **Installation of Headlight Beam Indicator Assembly.** Insert light outlet through instrument panel. Install tapered washer over light outlet with the thin side up. Screw the light body into place. Slide socket, spring, and fiber insulator, over the end of the wire. Round up the wire tip so the wire will enter the tip. Place tip on end of wire, pinch the tip to the wire and solder the tip to the wire. Install socket and lamp (subpar. a above).

d. **Replacement of Headlight Beam Control Switch.** Raise left upper corner of floor mat and remove the two screws which hold the switch to the toeboard. Pull the switch down through toeboard and disconnect the wires. To install, hold the switch in the position it will be installed, with the wire terminals away from the center of the vehicle. Connect the single black wire to the rear terminal of the switch, the red wire and brown wire to center terminal, and the

3/4-TON 4 x 4 TRUCK (DODGE)

other two wires to the front terminal. Insert switch button up through toeboard and install the two mounting screws in the toeboard with a toothed lock washer under the head of each screw.

107. BLACKOUT PARKING LIGHTS.

a. Replacement of Lamp. Loosen nut on mounting stud and turn front of light away from radiator guard. Remove light door. Remove lamp and install a new lamp, hang door in place, and install mounting screw at bottom of the door. Turn light so that it faces directly forward and tighten the mounting stud nut.

b. Removal of Parking Light Assembly. Slide rubber insulator along wire and disconnect wire at connector near terminal block on frame front cross member. Open wire clip on radiator shell and pull wire and loom out under light. Screw the loom off the light mounting bolt, then slide it off the wire. Remove nut from light mounting stud and lift light off fender.

c. Installation of Parking Light Assembly. Insert mounting stud through fender and install toothed lock washer and nut. Slide loom over wire and screw end of loom over mounting stud. Thread wire and loom over fender bracket and through clip on radiator shell and close the clip. Push wire terminal into connector and slide the rubber insulator over the connector.

108. BLACKOUT DRIVING LIGHT AND SWITCH.

a. Removal of Sealed Beam Unit (fig. 124). Remove screw at bottom of door and lift off door. Disconnect cable from center of sealed beam unit and release three wire clips which hold the retaining ring and sealed beam unit to door.

b. Installation of Sealed Beam Unit (fig. 124). Place sealed beam unit, then retaining ring in door, and spring the three retaining ring clips into place. Connect cable to the sealed beam unit, hang the door in place, and install the mounting screw at bottom of the door.

c. Removal of Blackout Driving Light Switch. Loosen set screw in switch button and unscrew knob from switch shaft. Remove nut which holds switch to instrument panel. Disconnect wires from switch.

d. Installation of Blackout Driving Light Switch. Connect wires to switch. Put switch shaft through instrument panel and install toothed lock washer and nut which holds switch to panel. Screw switch knob onto switch shaft and tighten set screw.

e. Removal of Blackout Driving Light Assembly (fig. 125). Remove mounting screw at bottom of door and lift out the door and sealed beam unit. Then disconnect cable from the center of the

LIGHTING SYSTEM

sealed beam unit. Close the clip on the end of wire loom to allow the cable to be pulled out of the light. Remove the nut from the light mounting bolt and lift the body off the fender.

f. Installation of Blackout Driving Light Assembly (fig. 125). Insert light mounting bolt through fender and install a lock washer and nut on mounting bolt. Push loom end of cable through hole in rear of light body and spread clip so that the loom cannot slide out of light. Connect the cable to center of sealed beam unit, hang the door in place, and install mounting screw at bottom of the door. Aim lamp (subpar. g below).

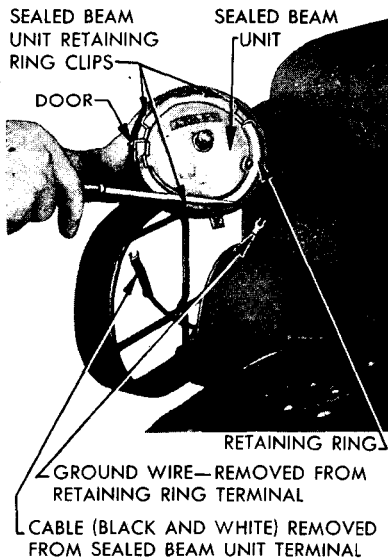

RA PD 52960

Figure 124—Installing Blackout Driving Light Sealed Beam Unit

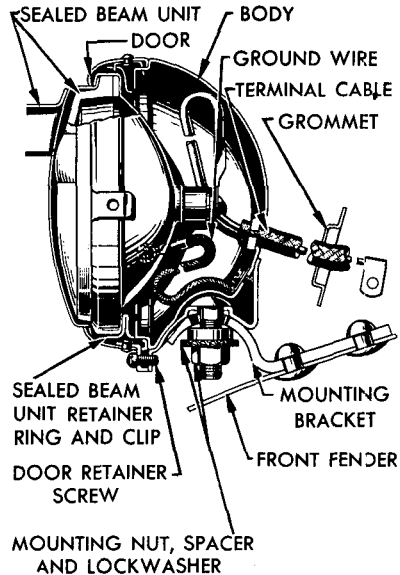

RA PD 52959

Figure 125—Blackout Driving Light

g. Aiming of Blackout Driving Light.

- (1) PREPARE VEHICLE AND SCREEN FOR AIMING (par. 105 e (1)).
- (2) LOCATE AND CENTER SCREEN (par. 105 e (2)).
- (3) LEVEL SCREEN (par. 105 e (3)).

(4) LOCATE CORRECT LIGHT POSITION ON SCREEN. Measure the distance from the top of the opening in the light to the floor. Hook the cord to the screen at the inch marks five inches below measured height of the light. Do not measure height of the cord from floor. Measure the distance from the center of the light to the center of the vehicle. Measure the same distance to the left of the heavy

3/4-TON 4 x 4 TRUCK (DODGE)

vertical center line on the screen and slide one of the vertical markers along the horizontal cord to that point.

(5) **AIM BLACKOUT DRIVING LIGHT.** Loosen blackout driving light mounting bolt nut and turn on the light. Aim the light so that the center of zone of highest intensity falls on the screen at the intersection of the horizontal cord and the vertical marker. Tighten the light mounting bolt nut securely.

109. TAIL AND STOP LIGHTS.

a. **Replacement of Sealed Beam Unit.** Remove two long mounting screws which hold light door in place and pull the door off the body. Pull the sealed beam unit out to remove and push it in to install. Place door on light body and install the attaching screws.

b. **Replacement of Tail and Stop Light Assembly.** The wires are connected to the light by two bayonet-type connectors. Push connector toward lamp, turn clockwise, then pull out. Remove two nuts from light mounting bolts and remove the light. To install, insert mounting bolts through light bracket and install toothed lock washers and nuts. Push connectors into sockets and turn counterclockwise.

c. **Replacement of Stop Light Switch.** The stop light switch is automatically operated by hydraulic pressure when the brake pedal is depressed. The switch is mounted on the brake line tee which is located on the inside of the frame side member just forward of the steering gear housing. To remove, pull the two wire connections straight up off the posts of the switch and unscrew the switch from the brake line tee. To install, start the threads on the switch into the brake line tee. Then slowly depress the brake pedal a short distance to force a little brake fluid out around the threads of the switch. While fluid is escaping, tighten the switch into place. Push the wire connectors straight down on posts of the switch.

110. INSTRUMENT LIGHTS AND SWITCH.

a. **Replacement of Lamp.** Pull the assembly sharply to one side to release its mounting prongs from the instrument panel. Pull the socket from the light body. Then turn the lamp counterclockwise and pull it from the socket. To install, push the lamp into the socket and turn it clockwise. Push the socket into the light body. Then push the assembly into the instrument panel with the slot straight down.

b. **Replacement of Instrument Light Switch.** Loosen set screw in switch knob and screw knob off switch shaft. Remove nut which holds switch to instrument panel. Then disconnect wires from switch. To install, connect wires to switch. Insert switch shaft through the instrument panel and install toothed lock washer and nut. Screw knob on switch shaft and tighten the set screw.

LIGHTING SYSTEM

c. **Replacement of Instrument Light Socket.** Remove lamp (subpar. a above). Slide the socket up the wire and pull small tip from end of wire. Then slide the fiber insulator, spring and socket off the wire. To install, slide the socket, spring and fiber insulator over the wire. Round up the wire tip so the wire will enter the tip. Place tip on end of wire and pinch tip to wire. Solder the tip to the wire. Install lamp (subpar. a above).

111. DOME LIGHTS.

a. **Replacement of Lamp.** Remove two screws which hold glass and bezel to the light body. Turn lamp counterclockwise and pull out of socket. To install, push lamp into socket and turn it clockwise. Install cork gasket, glass and bezel.

b. **Replacement of Dome Light Switch.** Remove two screws which hold switch to the instrument panel. Remove switch from back of instrument panel and disconnect wires. To install, connect wires to the switch. Hold the switch against instrument panel and install the two mounting screws with the toothed lock washer under the head of each screw.

c. **Replacement of Dome Light Assembly (Ambulance).** Remove the two screws which hold the glass and bezel to the light body. Then remove four screws which hold the light body to the roof. Remove lamp from socket and push body and socket up the wire. Then cut wire off close to fiber washer and pull wire out of light. To install, clear old wire out of hole in fiber washer. Peel about $\frac{1}{8}$ inch insulation off the wire. Then insert the wire through the socket and spring. Stick the bare end of the wire through the fiber washer and place a small drop of solder on the end of the wire. Pull socket down over fiber washer and install the lamp. Place light body in place in roof and install four screws. Install cork gasket, glass and bezel on light body and install two screws.

d. **Replacement of Dome Light Assembly (Carryall).** Remove screws which hold glass and bezel to light body and pull bezel straight down off body. Then remove screws which hold body to roof. Disconnect wire from light socket. To install, connect wire to lamp socket. Install two screws which hold light body to roof, then install two screws which hold glass and bezel to light body.

112. SPOTLIGHT (AMBULANCE).

a. **Replacement of Lamp** (fig. 126). Remove the door, lens, bulb, and reflector, as a unit. Unhook the three springs which hold the reflector to the door and lift the reflector and lamp away from the door and lens. Then remove the lamp from the socket by turning it counterclockwise. To install, place the flange of the lamp over the three prongs of the socket and turn the lamp clockwise. Place the

3/4-TON 4 x 4 TRUCK (DODGE)

lens and reflector with gasket into the door and connect the three retaining springs. Assemble the door, lens, lamp, and reflector, to the body as a unit and install the door.

b. Removal of Spotlight Assembly.

(1) **REMOVE CONTROL BODY AND GRIP.** Remove flat head screw directly over control grip and pull the grip down and out of control body. Then remove the small clamp which holds the wire to the shaft. Disconnect the wire from the main lighting and blackout switch. Remove the terminal from the wire and pull the wire through the instrument panel. Remove the nut and clamp bolt which holds the control body to the shaft and pull the control body off end of shaft.

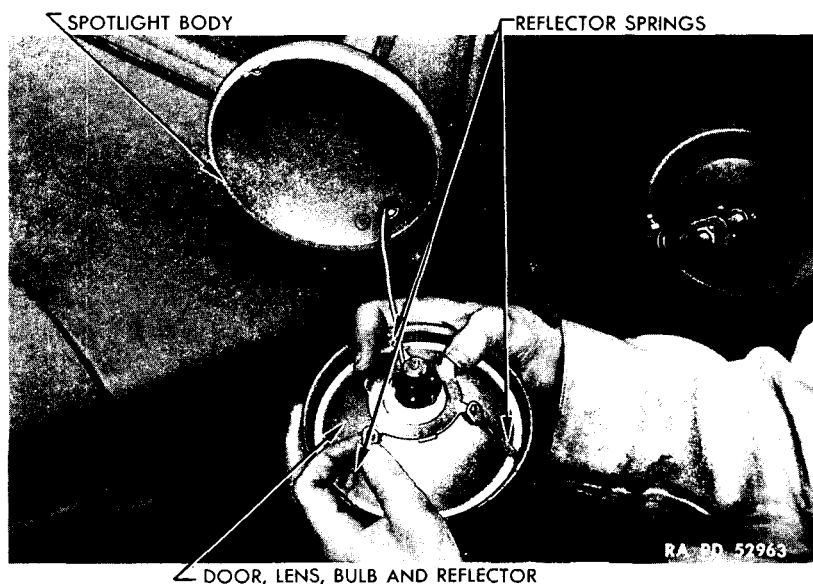

Figure 126—Installing Spotlight Lamp (Ambulance)

(2) **REMOVE SPOTLIGHT AND SHAFT.** Remove screw which holds bracket to instrument panel. Loosen clamp bolt and pull the bracket off end of shaft. Unscrew large nut from bracket at outside of body post and pull spotlight and shaft away from body.

c. Installation of Spotlight Assembly. If spotlight is assembled, remove control body and grip from shaft (subpar. b (1) above).

(1) **INSTALL SPOTLIGHT AND SHAFT.** Insert the shaft through the body post and screw large nut into bracket on body post. If there is misalignment, loosen the bracket from the body post. Slide inner bracket over the shaft and install screw in instrument panel and tighten the screws in the outer bracket if loosened. Then tighten the

LIGHTING SYSTEM

clamp bolt in the inner bracket enough to hold the spotlight in any position but still let the shaft be turned by the control grip.

(2) **INSTALL CONTROL BODY AND GRIP.** Turn the face of the spotlight at right angle to the shaft so that the gear racks on the inner ends of the small control shafts are even at the ends. Slide the control grip body over the shafts and into place so that the clamp bolt will slide through the notch in the shaft. Push the control grip into the control body and between the gear racks on the small control shafts. Install tension spring and screw in top of the control grip. Install and tighten nut on clamp bolt in the control body.

(3) **CONNECT WIRE AND WIRE CLAMP.** Insert wire through instrument panel, install terminal on wire and connect wire to headlights and taillight post of the main lighting and blackout switch (HT, fig. 127). Install clamp which holds wire to spotlight shaft.

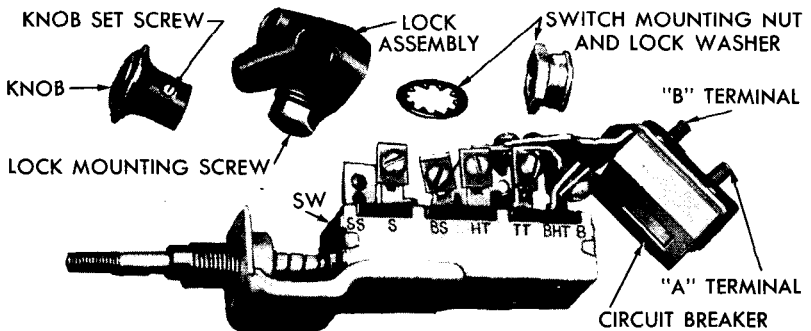

- S**—SERVICE STOP LIGHT TERMINAL—RED WITH TWO BLACK TRACERS
 - BS**—BLACKOUT STOP LIGHT TERMINAL—YELLOW WITH TWO BLACK TRACERS
 - TT**—TRAILER TAILLIGHTS TERMINAL—BLUE
 - HT**—HEAD AND TAILLIGHTS TERMINAL—YELLOW OR GREEN—INSTRUMENT LIGHT SWITCH FEED CABLE—RED—AMBULANCE SPOTLIGHT FEED CABLE—RED
 - BHT**—BLACKOUT HEAD AND TAILLIGHTS TERMINAL—BLACK WITH TWO WHITE TRACERS
 - SS**—STOP LIGHT SWITCH TERMINAL—BLACK AND RED
 - SW**—STOP LIGHT SWITCH FEED TERMINAL—BLACK AND YELLOW
 - A**—AUXILIARY FEED TERMINAL—AMBULANCE DOME LAMP—GREEN
 - B**—BATTERY TERMINAL—SWITCH FEED CABLE—BROWN
- RA PD 312561**

Figure 127—Main Lighting and Blackout Switch Wire Connections

113. MAIN LIGHTING AND BLACKOUT SWITCH.

a. **Removal of Switch Assembly.** Disconnect cable from battery to avoid damage from short circuit. Loosen set screw in switch knob and screw knob off switch shaft. Loosen mounting screw in lock assembly. Push lock assembly in to remove it. Unscrew mounting nut which holds switch to panel. Disconnect all wires from switch. Identify or tag wires as they are removed to insure proper assembly on terminals.

3/4-TON 4 x 4 TRUCK (DODGE)

b. Installation of Switch (fig. 127). Connect wires to proper terminals. Insert switch shaft through instrument panel and install toothed lock washer and mounting nut that holds switch in place. Push lock assembly in and install it over switch shaft with the lock button to the left. Hold lock assembly against instrument panel and tighten mounting screw. Screw knob onto switch shaft and tighten set screw. Connect battery cable to battery.

c. Removal of Circuit Breaker (fig. 127). Disconnect cable from battery to avoid damage from short circuit. Remove main lighting and blackout switch (subpar. a above). Disconnect wire from circuit breaker. Then remove two screws which hold circuit breaker to switch body.

d. Installation of Circuit Breaker (fig. 127). Install two screws which hold circuit breaker to switch, placing standard lock washer under head of each screw. Connect wire which runs from ammeter to upper post on circuit breaker. On Ambulance model only, connect dome light wire to lower post on circuit breaker. Install main lighting and blackout switch (subpar. b above). Connect cable to battery.

Section XXV

**INSTRUMENTS, GAGES, AND MISCELLANEOUS
ELECTRICAL EQUIPMENT**

	Paragraph
General description	114
Ammeter	115
Voltmeter (Command and Carryall)	116
Oil gage	117
Thermometer	118
Speedometer	119
Horn	120
Heater (Ambulance)	121
Roof ventilator (Ambulance)	122
Trailer connector	123

114. GENERAL DESCRIPTION.

a. **Instruments and Gages.** Replacement of all instruments and gages, mounted on the instrument panel, is described in this section, except the fuel gage which is covered in paragraph 72. The purpose and use of instruments and gages are explained in paragraph 5.

b. **Horn.** The horn circuit consists of a feed wire running from the generator regulator to the horn, a wire from the horn to a connector at the bottom of the steering gear, and up through the steering tube and worm to the horn button on the steering wheel. The horn circuit is completed by pressing the button, which grounds the circuit.

c. **Heater.** The Ambulance is equipped with a heater, defroster, and roof ventilator, which are operated by switches mounted on the left side of the instrument panel. The wiring diagram (fig. 137) shows the electrical connections for these units.

d. **Trailer Connector.** A trailer connector is mounted on the rear frame cross member of some models. Provision is made in the wiring of all models, except the Ambulance, for installation of a trailer connector.

115. AMMETER.

a. **Removal.** Disconnect cable from battery to avoid damage from short circuit. Disconnect wires from back of ammeter. Remove two nuts which hold mounting bracket against rear of instrument panel, and remove ammeter.

b. Installation.

(1) **INSTALL AMMETER.** Place ammeter in instrument panel from driver's side, and install the mounting bracket and round fiber disk over the two wire posts with the legs of the bracket against the instrument panel. Install a nut on each post and tighten.

3/4-TON 4 x 4 TRUCK (DODGE)

(2) CONNECT WIRES TO AMMETER (fig. 128).

(a) *Six-volt System.* Connect single red wire to left post of ammeter. Connect two brown wires and one black wire to right post of ammeter.

(b) *Twelve-volt System.* Connect one large red wire and one small red wire to left post of ammeter. Connect large black wire and two brown wires to right post of ammeter. Put standard lock washer under each terminal nut.

(3) CONNECT CABLE TO BATTERY (par. 88).

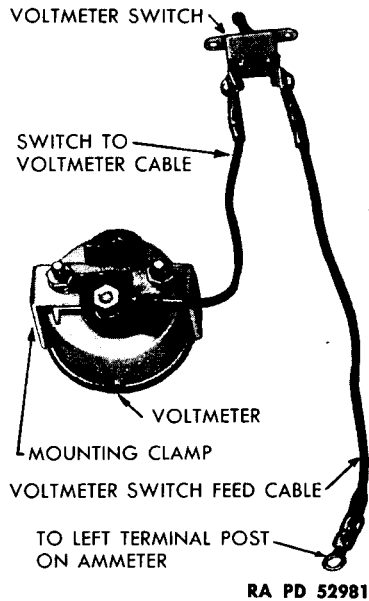
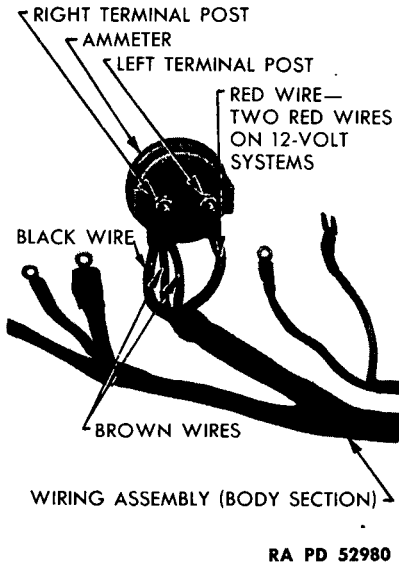

Figure 128—Ammeter Terminals **Figure 129—Voltmeter and Switch Wiring**

116. VOLTMETER (COMMAND AND CARRYALL).

a. Later production Command and Carryall vehicles are not equipped with a voltmeter.

b. **Removal of Voltmeter.** Turn voltmeter switch to "OFF" position and disconnect single wire from meter. Remove two nuts which hold the mounting bracket to back of the instrument panel and remove the voltmeter from the driver's side of instrument panel.

c. **Installation of Voltmeter** (fig. 129). Place the voltmeter in the instrument panel from the driver's side and install the mounting bracket over the two studs on the meter with the legs of the bracket against the instrument panel. Install the two attaching nuts with a standard lock washer under each nut. Connect the wire from the voltmeter switch.

**INSTRUMENTS, GAGES, AND MISCELLANEOUS
ELECTRICAL EQUIPMENT**

d. **Replacement of Voltmeter Switch** (fig. 129). Remove two screws which hold switch to the instrument panel. Remove switch from back of instrument panel and disconnect the two wires. To install, connect wires to the switch. Hold the switch against instrument panel and install the two mounting screws with a toothed lock washer under the head of each screw.

117. OIL GAGE.

a. **Removal.** Disconnect oil tube from gage. Remove two nuts which hold mounting bracket to instrument panel and remove gage from driver's side of instrument panel.



Figure 130—Dash Control Tube Covers

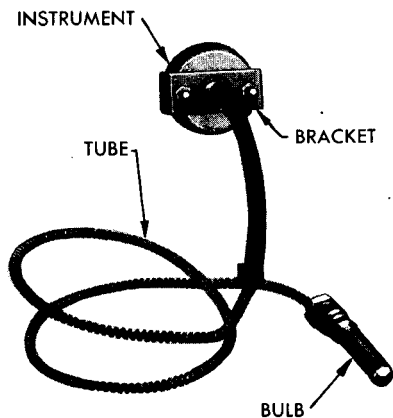

Figure 131—Thermometer

b. **Installation.** Place gage in the instrument panel from driver's side, and install the mounting bracket on the two studs on the gage with the legs of the bracket against the instrument panel. Install the two attaching nuts with a standard lock washer under each nut. Connect the oil tube to the gage.

118. THERMOMETER.

a. **Removal.**

- (1) DRAIN COOLING SYSTEM (par. 81).
- (2) DISCONNECT CABLE FROM BATTERY (par. 88).

3/4-TON 4 x 4 TRUCK (DODGE)

(3) REMOVE THERMOMETER BULB (fig. 131). Unscrew nut and pull thermometer bulb from left side of cylinder head. Open the clip which holds the tube to the cylinder head rear stud.

(4) REMOVE THERMOMETER TUBE AND BRACKET.

(a) *Vehicles Equipped with Ground Strap and Bracket* (fig. 130). Remove the two cap screws which hold the bracket to the dash and untie the ground strap. Remove the bracket and rubber grommet.

(b) *Vehicles Equipped with Clamp Bracket* (fig. 130). Remove the two screws which hold the upper part of the bracket to the lower part. Remove one and loosen the other cap screw which holds the bracket to dash and swing the lower part of bracket down.

(5) REMOVE ASSEMBLY. Remove two nuts which hold the mounting bracket to the instrument panel. Remove assembly from the driver's side of instrument panel.

b. Installation.

(1) INSTALL THERMOMETER. Insert the bulb end of the assembly through the instrument panel and dash from the driver's side of the panel. Install the mounting bracket over the two studs on the thermometer head with the legs of the bracket against the instrument panel. Place a standard lock washer and nut on each stud.

(2) INSTALL THERMOMETER TUBE AND BRACKET.

(a) *Vehicles Equipped with Ground Strap at Bracket* (fig. 130). Install rubber grommet over thermometer tube and control cables and the bracket over the grommet. Tie a new bond strap to the thermometer tube and control cables. Install the bracket to the dash with a toothed lock washer between each end of the bracket and the dash. Place another toothed lock washer and one end of the bond strap over each cap screw which holds the bracket to the dash. Install the screws and tighten securely.

(b) *Vehicles Equipped with Bond Clamp* (fig. 130). Swing lower part of the bracket up into place and install cap screw with a toothed lock washer under head of cap screw, tightening both cap screws securely. Place upper part of bracket over thermometer tube and control cables and install two screws with a toothed lock washer under head of each screw.

(3) INSTALL THERMOMETER BULB. Make a loop approximately two inches in diameter in the tube and place the looped tube in the clip at the cylinder head rear stud and close the clip. Install the bulb in the cylinder head and tighten the nut.

(4) CONNECT CABLE TO BATTERY (par. 88).

(5) FILL COOLING SYSTEM (par. 81).

119. SPEEDOMETER.

a. **Removal of Head.** Disconnect speedometer drive cable from speedometer. Open wire clip and move wiring assembly away from upper wing nut on mounting bracket. Remove the two wing nuts which hold mounting bracket to back of instrument panel and

INSTRUMENTS, GAGES, AND MISCELLANEOUS ELECTRICAL EQUIPMENT

remove the speedometer from the driver's side of the instrument panel.

b. Installation of Head. Place the speedometer in the instrument panel from the driver's side and install the mounting bracket with the wire clip and a plain washer on the upper stud and a standard lock washer under each wing nut. Put the wiring assembly in the wire clip and close the clip. Insert the squared speedometer drive shaft into the speedometer head so that the flange on the cable housing is against the speedometer. Then screw the connecting nut into place.

c. Removal of Cable.

- (1) DISCONNECT CABLE FROM BATTERY (par. 88).
- (2) REMOVE FLOOR PLATES (par. 133 a (1) through (3)).
- (3) DISCONNECT AND REMOVE CABLE.

(a) *Early Models.* Disconnect cable from transmission. Remove clip which holds cable to underside of toeboard riser. Remove clip which holds cable to engine side of dash and remove control cable bracket at dash (fig. 131). Disconnect cable assembly from speedometer head and remove cable assembly.

(b) *Late Models.* Disconnect cable from transmission. Remove spare parts kit box under map board. Remove clips which hold cable to driver's side of dash and frame side member. Disconnect cable from speedometer head and remove cable assembly.

d. Installation of Cable.

- (1) CONNECT CABLE TO SPEEDOMETER HEAD.

(a) *Early Models.* String cable assembly through dash, with smaller connecting nut to driver's side. Insert square end of speedometer drive shaft into speedometer head so that flange on the cable housing is against the speedometer, then screw the connecting nut into place. Install control cable bracket (par. 118 b (2)).

(b) *Late Models.* String cable assembly along driver's side of dash and insert square end of drive shaft into speedometer head so that flange on cable is against the speedometer, then screw connecting nut into place.

- (2) CONNECT CABLE TO TRANSMISSION.

(a) *Early Models.* Make loop in cable housing, between control cable bracket and clip on dash, as large as possible to prevent breakage of drive cable. Install clip which holds cable to engine side of dash, and clip which holds cable to underside of toeboard riser. Connect speedometer cable to transmission.

(b) *Late Models.* Install clips which hold cable in position on driver's side of dash and frame cross member and connect cable to transmission. Position cable so that it lies along top of frame side member.

- (3) INSTALL FLOOR PLATES (par. 133 b (8) through (10)).
- (4) CONNECT CABLE TO BATTERY (par. 88).

3/4-TON 4 x 4 TRUCK (DODGE)

120. HORN.

a. **Removal of Horn.** Remove cable from battery to avoid damage from short circuit. Remove two nuts which hold wires to terminal posts on horn. Remove two nuts which hold horn to bracket and remove horn.

b. **Installation of Horn.** Insert horn mounting studs through bracket and install a toothed lock washer and nut on each stud. Connect horn button wire to lower post and wire from regulator to upper post of horn. Connect cable to battery.

c. **Horn Adjustment (fig. 132).** Loosen the lock nut and turn the adjusting screw counterclockwise until the motor is actuated but the horn does not vibrate. Then turn the screw approximately 1/4 turn clockwise and tighten the lock nut.

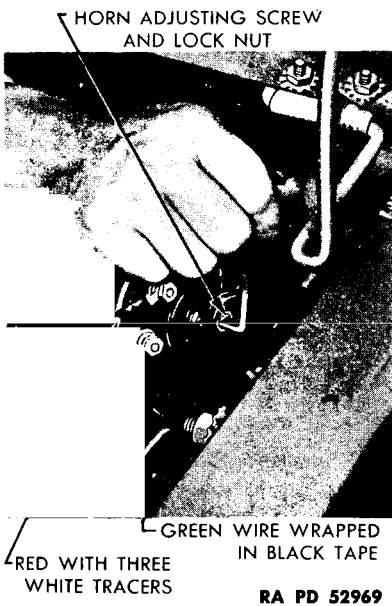

Figure 132—Adjusting Horn

Figure 133—Installing Horn Button Cable

d. **Removal of Horn Button and Wire (fig. 133).** Disconnect horn wire at the connector near bottom of steering housing, slide the rubber insulator along the wire and pull the connector apart. Tie a string securely to the lower end of the wire so it will be pulled into the steering column as the wire is pulled out. The string can be used to pull the new wire down through the column. Press down on the horn button and turn it clockwise, release the pressure and the button will pop out. Pull the horn wire out the top of the column and untie the string.

INSTRUMENTS, GAGES, AND MISCELLANEOUS ELECTRICAL EQUIPMENT

e. **Installation of Horn Button and Wire** (fig. 133). If a pilot string has been left in the steering column, run the string through the horn button spring and tie the string securely to the end of the horn wire and pull the wire down through the column. Place the horn button over the spring in the steering wheel and press it down, then turn it counterclockwise and release the pressure. Remove the string from the lower end of the wire, push the wire connector together, and slide the rubber insulator over the connector.

121. HEATER (AMBULANCE).

a. **Removal of Heater Switch.** Pull switch knob straight down and off switch. Remove nut which holds switch to instrument panel. Then disconnect wires from switch.

b. **Installation of Heater Switch.** Connect the two single wires to the left post of the switch and the double wire connection to the right post. (Right and left posts viewed from front of switch when installed in vehicle.) Insert shank of switch through instrument panel and install nut. Place the switch knob over the end of the switch shaft so that the small boss in the hub of the knob registers with slot in the switch shaft. Then push the knob into place.

c. **Removal of Defroster Assembly.** Disconnect the feed wire from the defroster switch and disconnect the inlet and output tubes from the defroster blower. Remove two mounting stud nuts from engine side of dash, and remove the defroster from driver's side of the dash.

d. **Installation of Defroster Assembly.** Insert the mounting studs through the dash. Place dash ground strap over lower mounting stud, a toothed lock washer over each stud, and install the nuts. Connect the inlet and two output tubes to the defroster. Then connect the feed wire to the defroster switch.

e. **Removal of Defroster Switch.** Pull switch knob straight down and off switch. Remove nut which holds switch to the instrument panel. Pull switch out of instrument panel and disconnect wires.

f. **Installation of Defroster Switch.** Connect the larger wire to the left post of the switch and the smaller wire to the right post. Insert the shank of the switch through the instrument panel and install the nut which holds the switch in place. Place the knob over the end of the switch shaft so that the small boss in hub of the knob registers with the slot in the shaft, and push the knob into place.

g. **Removal of Heater Assembly.** Drain the radiator (par. 81). Disconnect the feed wire from the starting switch and disconnect the two hose from heater at engine side of dash. Remove four nuts and bolts which hold the heater to the dash and remove the heater.

h. **Installation of Heater Assembly.** Insert the heater water tubes through the dash and install the five mounting bolts with a toothed lock washer under each nut. Connect the water hose which runs from

3/4-TON 4 x 4 TRUCK (DODGE)

front of engine to the upper tube of heater and the hose which runs from rear of the engine to the lower tube of heater. Connect the feed wire to the heater switch. Fill the radiator (par. 81). If water does not circulate through heater radiator when engine is warmed up and running, loosen hose connection at upper heater tube and allow air to bleed out of heater radiator.

122. ROOF VENTILATOR (AMBULANCE).

a. **Replacement of Switch.** Remove two screws which hold switch to the instrument panel. Remove switch from back of instrument panel and disconnect wires. To install, connect wires to the switch. Hold the switch against instrument panel and install the two mounting screws with a toothed lock washer under the head of each screw.

← WIRING ASSEMBLY—LOWER

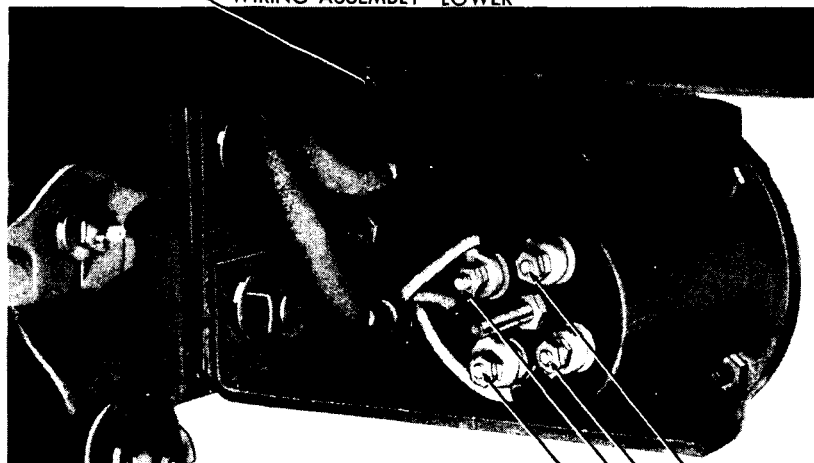

TERMINAL MARKED "SL" GREEN AND BLACK WIRE
TERMINAL MARKED "BK" NO WIRE
TERMINAL MARKED "GR" GREEN WIRE
TERMINAL MARKED "TL" BLUE WIRE

RA PD 312562

Figure 134—Trailer Connector Wiring

b. **Removal of Roof Ventilator Assembly.** Remove three screws which hold the ventilator deflector to the top of the roof. Remove eight screws which hold the ventilator assembly to the roof and lift the ventilator out through the top of roof. After lifting the ventilator assembly out of the roof, disconnect the feed wire from the ventilator.

c. **Installation of Roof Ventilator Assembly.** Connect the feed wire to the terminal on the ventilator. Lower the ventilator into

**INSTRUMENTS, GAGES, AND MISCELLANEOUS
ELECTRICAL EQUIPMENT**

opening in the roof and install the eight screws which hold the assembly in place. Place a toothed lock washer under the head of each screw. Install the ventilator deflector over the assembly with the high portion of the deflector forward. Install the three attaching screws with a toothed lock washer under the head of each screw.

123. TRAILER CONNECTOR.

a. Removal. Remove nut which holds cap to connector body. Disconnect wire from connector. Remove four bolts and nuts which hold connector body and cover to mounting bracket.

b. Installation.

(1) **INSTALL CONNECTOR.** Place connector body through mounting bracket with groove and drain hold down. Place cover assembly over the top two bolt holes and install the mounting bolts, standard lock washers, and nuts.

(2) **CONNECT WIRES** (fig. 134). Connect blue wire to the upper left post; longer green wire to the lower left post; and the short green and black wire to the lower right post. Attach wires as follows: Place toothed lock washer and small plain washer on the post of the connector. Then place wire terminal and terminal shield on post and install standard lock washer and nut. Arrange the wires so that the terminal cap will go into place, and install toothed lock washer and nut which hold cap to the connector body.

3/4-TON 4 x 4 TRUCK (DODGE)

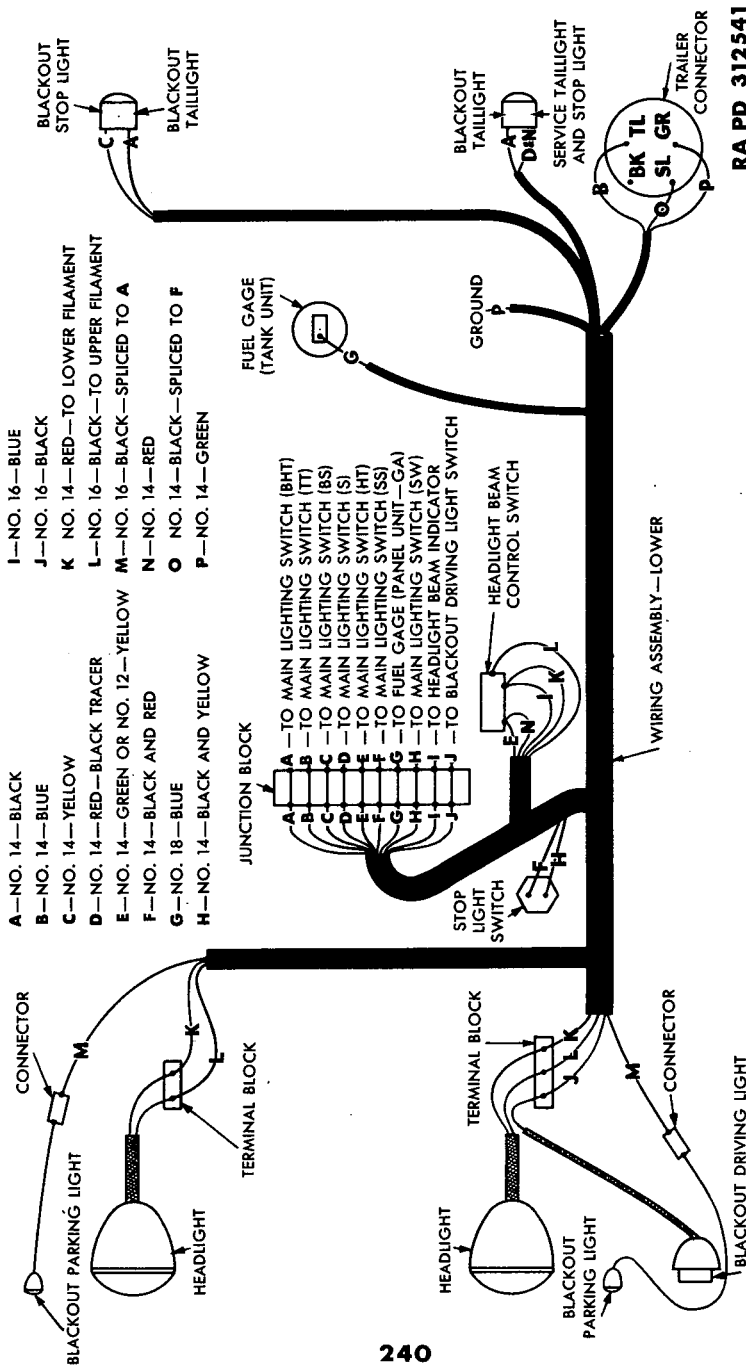

RA PD 312541

Figure 135—Wiring From Junction Block to Lights and Fuel Gage

Section XXVI

WIRING

	Paragraph
Description	124
Lower wiring assembly (junction block to lights)	125
Upper wiring assembly (junction block to instrument panel) ..	126
Body wiring assembly (filter to instrument panel)	127
Generator to regulator wiring assembly	128

124. DESCRIPTION.

a. General.

(1) All electrically operated units on the vehicle, except the ignition coil and the horn, are constantly grounded to the vehicle chassis through their mounting. The coil is intermittently grounded to the chassis when the breaker points in the distributor are closed. The horn is grounded when the horn button is depressed. The negative post of the battery is also constantly grounded to the chassis.

(2) A single cable, connected to the positive post of the battery, runs directly to the feed post on the cranking motor switch. When the switch is closed, current flows from the battery through the cranking motor to ground. No other wiring is involved in the starting circuit.

(3) From the feed post on the cranking motor switch and the generator regulator, single feed wires run through the radio interference filter to the ammeter. From the ammeter, single feed wires, which are built into assemblies, run indirectly through switches to all electrically operated units, except the cranking motor. When the switch which controls any unit, except the cranking motor, is closed, current flows from the battery through the ammeter, through the switch and single wire in the wiring assemblies, then through the unit to ground.

b. Wiring Assemblies (figs. 135, 136, 137 and 138).

(1) **UPPER WIRING ASSEMBLY (figs. 136 and 137).** This assembly contains a group of single-feed wires which run from the main lighting and blackout switch, blackout driving light switch, headlight beam indicator, and fuel gage on the instrument panel to the driver's side of the junction block on the dash. The road lights or fuel gage only can be affected by this wiring assembly.

(2) **LOWER WIRING ASSEMBLY (fig. 135).** This assembly contains a group of single-feed wires which run from the engine side of the junction block on the dash to all road lights, headlight beam control switch and fuel gage tank unit. The road lights or fuel gage only can be affected by this wiring assembly.

(3) **BODY WIRING ASSEMBLY (figs. 136 and 137).** This assembly contains two feed wires which run from the radio interference filter to the ammeter; also feed wires which run from the ammeter to the

3/4-TON 4 x 4 TRUCK (DODGE)

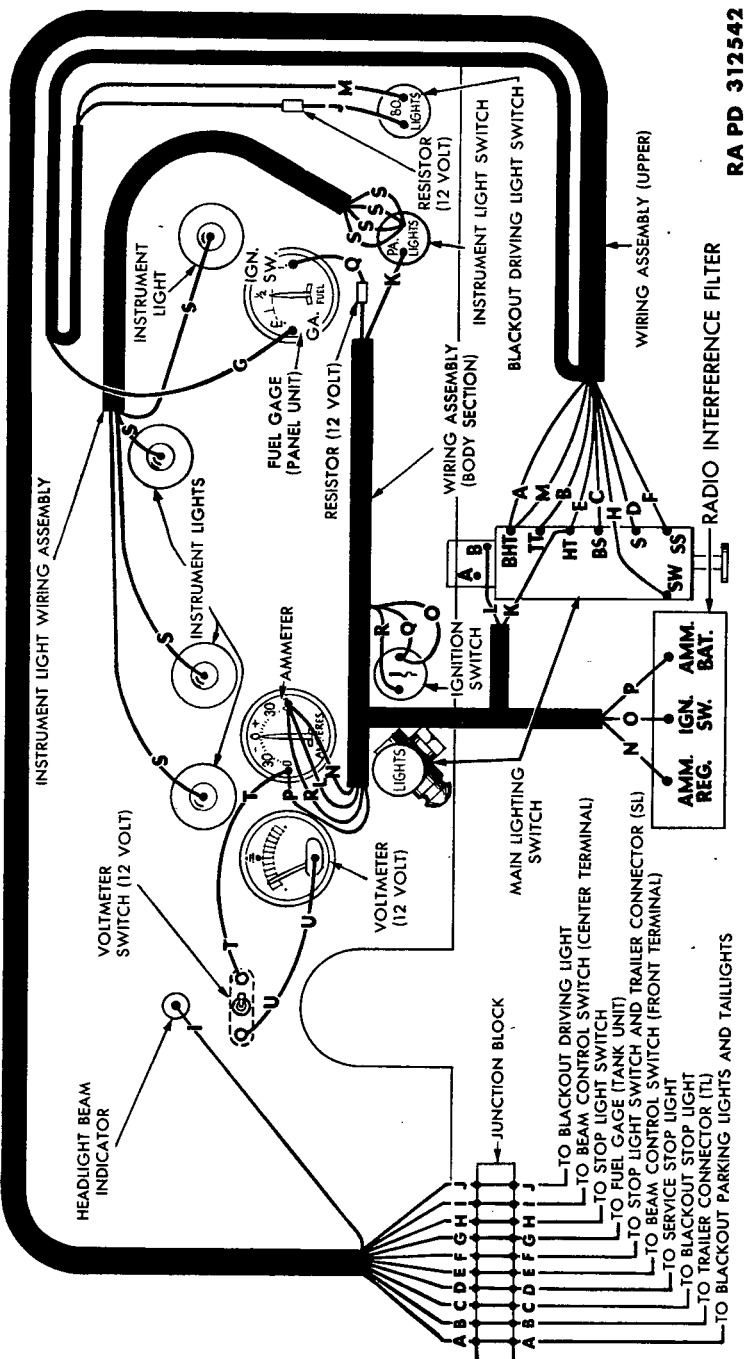

Figure 136—Instrument Panel Wiring (Open Bodies)

WIRING

A —NO. 14—BLACK	M —NO. 14—BLACK
B —NO. 14—BLUE	N —NO. 10—BLACK (6 VOLT)
C —NO. 14—YELLOW	O —NO. 8—BLACK (12 VOLT)
D —NO. 14—RED—BLACK TRACER	P —NO. 14—BLACK
E —NO. 14—GREEN OR NO. 12—YELLOW	P —NO. 10—RED (6 VOLT)
F —NO. 14—BLACK AND RED	P —NO. 8—RED (12 VOLT)
G —NO. 18—BLUE	Q —NO. 12—BLUE OR
H —NO. 14—BLACK AND YELLOW	NO. 12—GREEN
I —NO. 16—BLUE	R —NO. 12—BROWN
J —NO. 16—BLACK	S —NO. 16—BLACK
K —NO. 16—RED	T —NO. 16—RED
L —NO. 12—BROWN	U —NO. 16—RED

RA PD 312542B

Legend for Figure 136—Instrument Panel Wiring (Open Bodies)

3/4-TON 4 x 4 TRUCK (DODGE)

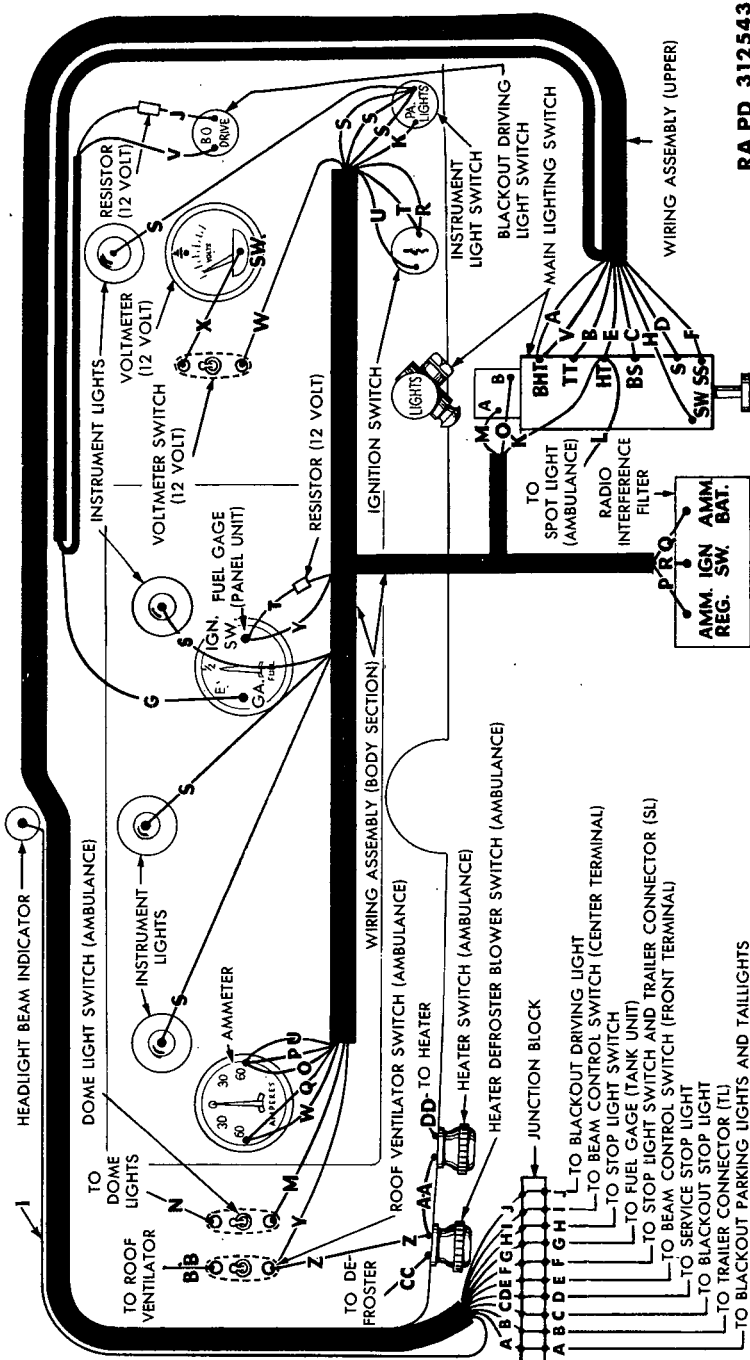

RA PD 312543

Figure 137—Instrument Panel Wiring (Closed Bodies)

WIRING

A —NO. 14—BLACK	P —NO. 8—BLACK (12 VOLT)
B —NO. 14—BLUE	Q —NO. 10—RED (6 VOLT)
C —NO. 14—YELLOW	Q —NO. 8—RED (12 VOLT)
D —NO. 14—RED—BLACK TRACER	R —NO. 14—BLACK
E —NO. 14—GREEN OR NO. 12—YELLOW	S —NO. 16—BLACK
F —NO. 14—BLACK AND RED	T —NO. 12—BLUE OR NO. 12—GREEN
G —NO. 18—BLUE	U —NO. 12—BROWN
H —NO. 14—BLACK AND YELLOW	V —NO. 14—BLACK
I —NO. 16—BLUE	W —NO. 16—RED
J —NO. 16—BLACK	X —NO. 16—RED
K —NO. 16—RED	Y —NO. 12—RED
L —NO. 18—RED	Z —NO. 12—RED
M —NO. 16—GREEN	AA —NO. 12—RED
N —NO. 18—YELLOW	BB —NO. 18—RED
O —NO. 12—BROWN	CC —NO. 18—BLACK
P —NO. 10—BLACK (6 VOLT)	DD —NO. 12—RED

RA PD 312543B**Legend for Figure 137—Instrument Panel Wiring
(Closed Bodies)**

main lighting and blackout switch, instrument light switch, ignition switch, fuel gage; and a wire which runs from the ignition switch to the radio interference filter. Any electrical unit on the vehicle, except the cranking motor, can be affected by this wiring assembly.

(4) **GENERATOR TO REGULATOR WIRING ASSEMBLY** (fig. 138). This assembly contains two wires which run from the generator to the generator regulator. Only the charging rate of the generator will be affected by this assembly.

c. Words "Right" and "Left." Use of these words in this section to designate location of wires and terminals is defined in the following steps:

(1) **"RIGHT."** The side of the vehicle opposite the driver's side where the steering gear is mounted. For example, the use of the words "right post of ignition switch" (par. 127 c (2) (a)) means the post on the side of the ignition switch opposite the steering gear side of the vehicle when the switch is installed in its normal position on the vehicle. The word "right" is not used in this manual to refer to positions or locations in relation to the body of the mechanic doing the work.

(2) **"LEFT."** The driver's side of the vehicle where the steering gear is mounted. The side opposite the right side. For example, the use of the words "left light upper socket" (par. 125 c (2)) means the upper socket of the taillight on the driver's side (steering gear side) of the vehicle when the taillight is installed in its normal position on the vehicle. The word "left" is not used in this manual to refer to positions or locations in relation to the body of the mechanic doing the work.

3/4-TON 4 x 4 TRUCK (DODGE)

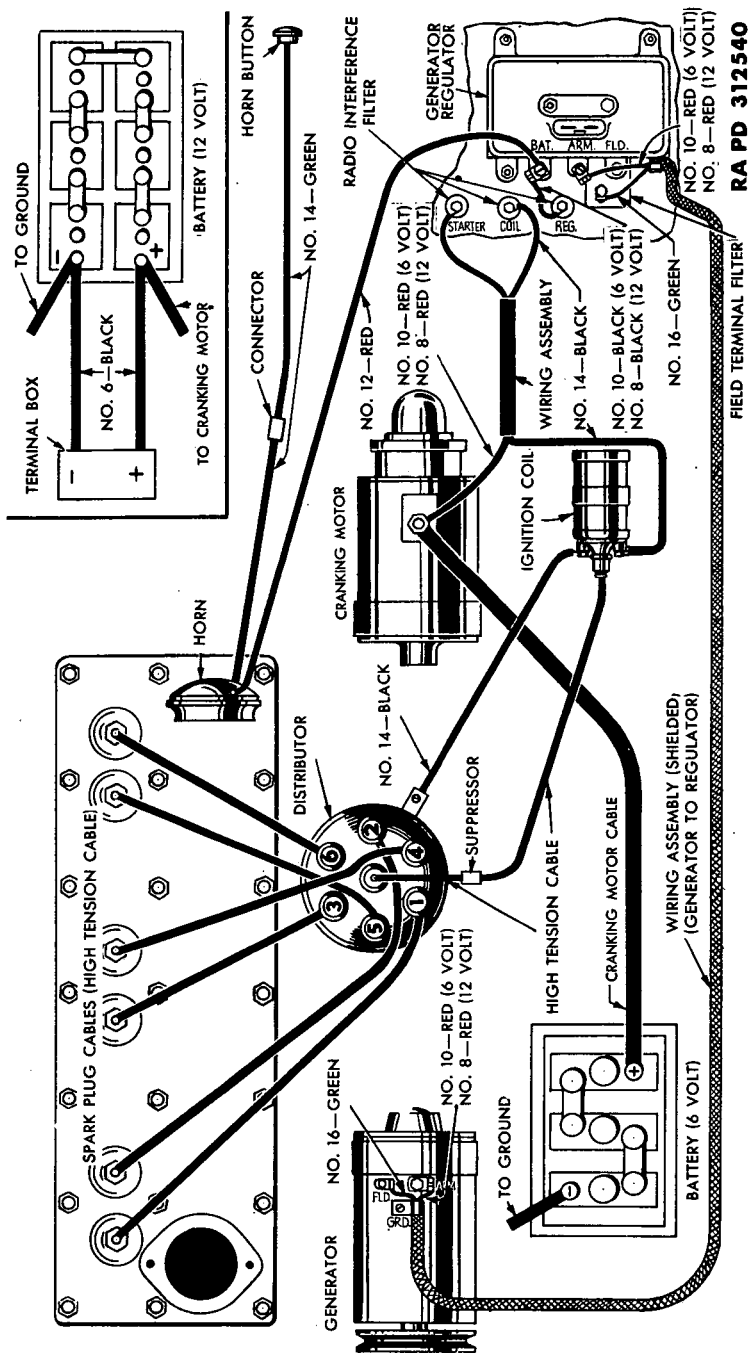

Figure 138—Wiring Under the Hood

WIRING**125. LOWER WIRING ASSEMBLY (JUNCTION BLOCK TO LIGHTS).**

a. **Description** (fig. 135). The lower wiring assembly contains only lighting system wires and a wire to the fuel gage tank unit. Feed wires from the junction block to all road lights are built into the assembly.

b. **Removal** (fig. 135).

(1) **DISCONNECT WIRES.** Disconnect all wires from engine side of the junction block. Then open wire clips on dash and steering gear housing. Remove headlight beam control switch and disconnect wires (par. 106). Pull wire connector straight up and off post on stop light switch.

(2) **REMOVE REAR SECTION OF WIRING ASSEMBLY.** Open seven clips which hold wire assembly to frame side member. Remove fuel tank to get to clip opposite the end of the fuel tank (par. 71). Remove two clips which hold right taillight wires, and two clips which hold fuel gage wire to frame cross member. On all vehicles (except Ambulance) open clip which holds left taillight wires to end of frame cross member. Turn taillight wire connectors clockwise and pull them out of lights. Disconnect ground wire from frame (all models except Ambulance). If vehicle is equipped with a trailer connector, remove cap from connector and disconnect wires.

(3) **REMOVE FRONT SECTION OF WIRING ASSEMBLY.** Open clip which holds wiring assembly to frame side member just forward of stop light switch, and three clips which hold wiring assembly to the frame front cross member. Disconnect wires from headlight terminal blocks one at a time and put wire from light back on post to facilitate installation. Disconnect blackout parking light wires by separating the connectors in the wires. Then remove the wiring assembly.

c. **Installation** (fig. 135).

(1) **INSTALL FRONT SECTION OF WIRING ASSEMBLY.** String the shorter section of the assembly forward through the clip on the frame side member and the three clips on the frame cross member and close the clips. Connect the wires to the blackout parking lights. Connect the headlight and blackout driving light wires to the terminal blocks so that the color of each wire matches the color of the feed wire which runs to the light.

(2) **INSTALL REAR SECTION OF WIRING ASSEMBLY.** String the rear section of the wiring assembly through the eight clips on the channel of the frame side member and close the clips. Install the two clips which hold the right taillight wires, and two clips which hold the fuel gage wires to the frame cross members and (all models except Ambulance) put the left taillight wires through clip on the end of frame side member and close the clip. Connect taillight wires. Connect the yellow wire to right light upper socket and the black wire to the lower socket. Connect the two red wires to the left light upper socket and the black wire to the lower socket. If vehicle is equipped with trailer connector, connect three wires which are taped

3/4-TON 4 x 4 TRUCK (DODGE)

together to trailer connector and install cap. Refer to paragraph 123 for position of wires. If vehicle (except Ambulance) is not equipped with trailer connector, tape ends of trailer connector wires separately, then together, and place them in frame rear cross member. On all models (except Ambulance) connect single taped ground wire to the rear end of frame side member.

(3) **INSTALL FUEL TANK** (par. 71).

(4) **CONNECT WIRES AND INSTALL HEADLIGHT BEAM CONTROL SWITCH** (par. 106).

(5) **CONNECT WIRES TO STOP LIGHT SWITCH AND JUNCTION BLOCK.** Push connector straight down on stop lamp switch post.

CONNECT WIRES TO THE JUNCTION BLOCK TERMINAL POSTS SO THAT THE WIRE COLORS CORRESPOND ON EACH SIDE OF THE JUNCTION BLOCK.

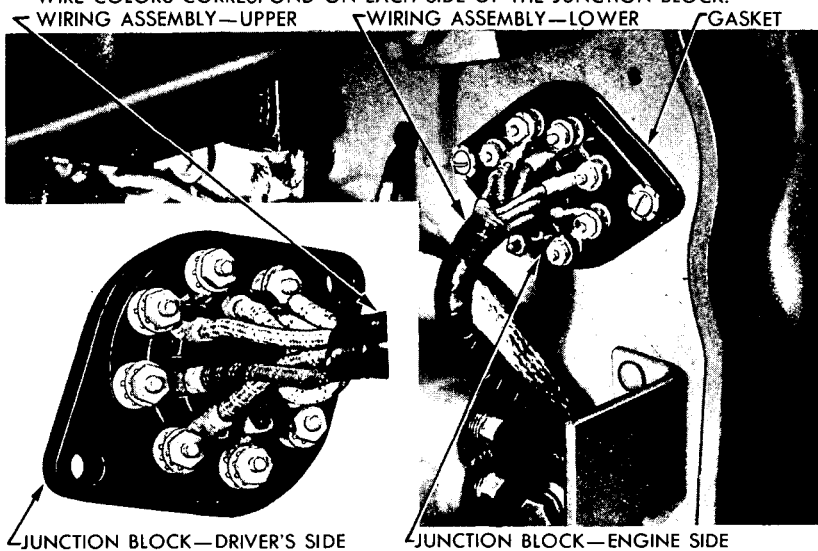

RA PD 52976

Figure 139—Wiring Junction Block

Remove two screws which hold the junction block in place and pull the block forward a few inches. Connect the wires to the junction block so that the color of each wire matches the color of the wire on the other end of the block terminal (fig. 139). Install junction block in dash. Put wire assembly in clips on dash and steering gear housing and close the clips.

126. UPPER WIRING ASSEMBLY (JUNCTION BLOCK TO INSTRUMENT PANEL).

a. **Description** (figs. 136 and 137). The upper wiring assembly contains only light wires and the fuel gage instrument panel unit

WIRING

wire. No difficulty other than with road lights or the fuel gage can occur in this assembly.

b. Removal (figs. 136 and 137).

(1) REMOVE MAIN LIGHT SWITCH (par. 113 a).

(2) DISCONNECT WIRES. Disconnect the wires of the assembly from the main lighting and blackout switch. Disconnect wire from fuel gage instrument panel unit. Pull socket and bulb from headlight beam indicator and remove the bulb. Remove blackout driving light switch (par. 108) and disconnect two wires from it. Disconnect nine wires from junction block at driver's side of dash and remove wire assembly.

c. Installation (figs. 136 and 137).

(1) CONNECT WIRES TO JUNCTION BLOCK (fig. 139). Remove two screws which hold junction block to engine side of dash and pull block away from dash. Insert end of wire assembly through dash and connect nine wires to the junction block so that the color of each wire matches the color of the wire on the other end of the terminal, then install the junction block in the dash.

(2) CONNECT WIRES TO SWITCHES, HEADLIGHT BEAM INDICATOR, AND FUEL GAGE. String wiring assembly over the steering column brace and the two longer wires, which are taped together, onto the blackout driving light switch. Connect the two wires to the blackout driving light switch and install the switch in the instrument panel (par. 108). Install the bulb in socket on the longest wire and push the socket into the headlight beam indicator. Connect the next longest wire to the fuel gage instrument panel unit. Connect the remaining wires of approximately the same length to the main lighting and blackout switch. Refer to figure 136 or 137 for proper position of wires.

(3) INSTALL MAIN LIGHTING AND BLACKOUT SWITCH (par. 113).

127. BODY WIRING ASSEMBLY (FILTER TO INSTRUMENT PANEL).

a. **Description** (figs. 136 and 137). The body wiring assembly carries current from the battery and generator through the ammeter to the switches which control all electrical units on the vehicle, except the cranking motor. Current furnished by the generator in excess of the immediate demand passes back from the ammeter through this wiring assembly and is stored in the battery.

b. Removal (figs. 136 and 137).

(1) DISCONNECT BATTERY CABLE (par. 88).

(2) DISCONNECT WIRES.

(a) *All Models*. Disconnect three wires from radio interference filter on driver's side of dash and one wire from main lighting and blackout switch. Disconnect one wire from the circuit breaker (all models except Ambulance; two wires on Ambulance). Disconnect single wire from fuel gage (all models except Ambulance; two wires on Ambulance). Disconnect single wire from left side and double

3/4-TON 4 x 4 TRUCK (DODGE)

wire from right side of ignition switch. Disconnect single wire from right side and group of wires from left side of instrument light switch. Remove all instrument light lamps. Disconnect three-wire group from right side, and single wire from left side of ammeter on all 6-volt systems. Disconnect single wire and two groups of two wires each from right side, and two single wires from left side of ammeter on all 12-volt systems.

- (b) *Ambulance Only.* Disconnect single wire from upper terminal of roof ventilator switch and group of two wires from upper terminal of dome light switch. Also disconnect group of two wires from heater switch, and one wire from defroster switch.

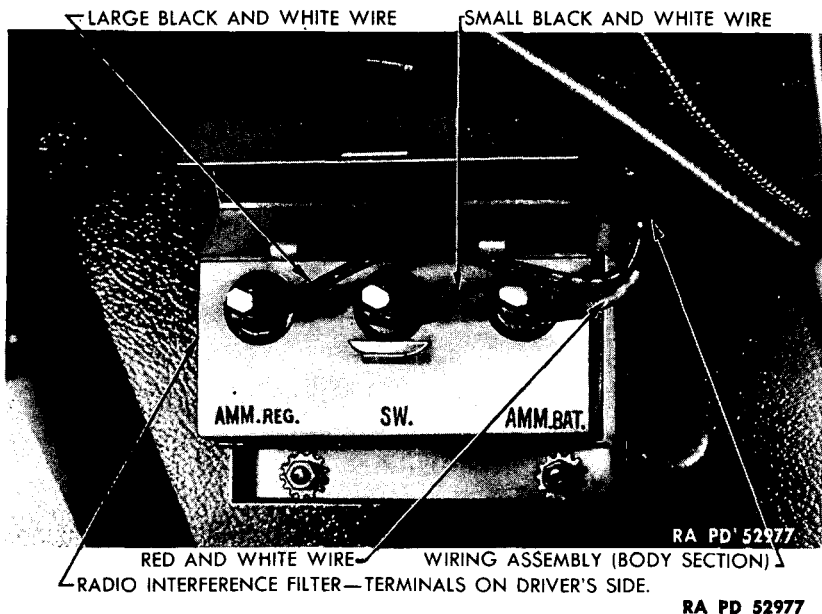

Figure 140—Radio Interference Filter—Driver's Side

(3) **REMOVE WIRING ASSEMBLY.** Open two clips that hold wiring assembly to steering column brace, one clip which holds assembly to lower flange of instrument panel, and one clip at speedometer mounting bracket. Then remove assembly.

c. Installation (figs. 136 and 137).

(1) **INSTALL WIRING ASSEMBLY.** String wiring assembly through two clips on steering column brace; one clip on lower flange of instrument panel and clip at speedometer mounting bracket. String the branch which runs to the right of the panel through hole in cowl ventilator handle bracket. When assembly is in place, close all clips.

WIRING

(2) CONNECT WIRES.

(a) *All Models.* Connect large black and white wire to left post of radio interference filter (fig. 140), small black and white wire to center post of filter and large red and white wire to right post of filter. Connect brown wire on upper post of circuit breaker. On Ambulance only, connect green wire to lower post of circuit breaker. On all models except Ambulance, connect green and white wire to fuel gage. On Ambulance only, connect green and white, and red and white wires to same terminal on fuel gage. Connect red wire to main lighting and blackout switch terminal marked "HT". Connect single brown wire to left post of ignition switch; connect black and white, and green and white wires to right post of ignition switch. Connect single red wire to right side, and group of black wires to left side of instrument light switch. Install all instrument light bulbs.

(b) *Six-volt System.* Connect single red wire to left post of ammeter, and connect two brown, and one black and white wires to right post of ammeter.

(c) *Twelve-volt System.* Connect one large red wire, and one small red wire to left post of ammeter; and connect large black wire, and two brown wires to right post of ammeter.

(d) *Ambulance Only.* Connect single wire to upper terminal of roof ventilator switch. Connect wire to upper terminal of dome light switch, pair of red wires to heater switch, and single red wire to the defroster switch.

(3) CONNECT CABLE TO BATTERY (par. 88).

128. GENERATOR TO REGULATOR WIRING ASSEMBLY.

a. **Removal** (fig. 138). Disconnect two wires from generator regulator. Disconnect two wires from generator. Remove wire clips which hold wire assembly to generator and regulator and open clip at dash. Then remove three clips which hold the assembly to the fender. On vehicles with 6-volt electrical systems, remove clip from battery hold-down bolt.

b. **Installation** (fig. 138). String wiring assembly into place with longer terminal on small wire to the regulator. Install three clips and special washers which hold the assembly to the fender. Attach wire clips to generator and regulator with toothed lock washer below and above each clip, and close the clip at the dash. On vehicles with 6-volt electrical system, install wire clip on battery hold-down bolt with toothed lock washer below and above clip. Connect large wire to center terminal strap with a standard lock washer under head of screw. Connect small wire to lower post of regulator with a toothed lock washer under head of screw. Connect wires to generator terminal post with a standard lock washer under each nut.

3/4-TON 4 x 4 TRUCK (DODGE)

Section XXVII

CLUTCH

	Paragraph
General description	129
Clutch pedal	130
Clutch disk and release bearing	131

129. GENERAL DESCRIPTION.

a. The clutch is the single dry plate type. A steel cover bolted to the flywheel encloses the clutch disk, the pressure plate, the pressure springs, and fingers. A composition facing is riveted to each side of the clutch disk. Coiled springs assembled around the hub of the disk absorb power shocks and torsional vibration.

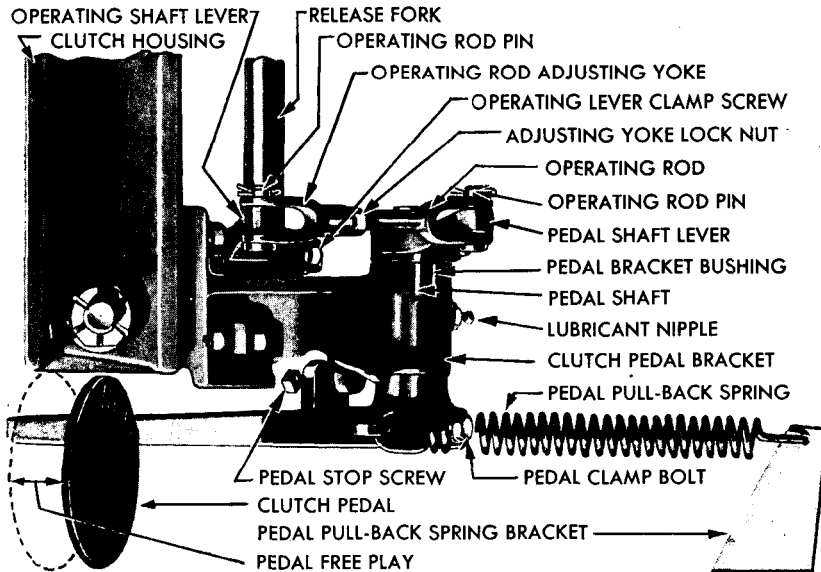

RA PD 52904

Figure 141—Clutch Pedal Adjustments

130. CLUTCH PEDAL.

a. Description (fig. 141). The backward travel of the clutch pedal is limited by a stop screw so that the pedal has $\frac{1}{2}$ inch clearance between the pedal and the bottom of the floor plate. Clutch pedal free play should be adjusted when the clutch pedal pad has less than $\frac{1}{8}$ inch free movement from the released position to the point where the clutch starts to release.

CLUTCH

b. Adjustment.

(1) **DISCONNECT CLUTCH OPERATING ROD** (fig. 141). Remove cotter pin and rod pin to disconnect clutch operating rod from the clutch operating shaft lever.

(2) **ADJUST LOCATION OF PEDAL.** Loosen the lock nut on the stop screw which is screwed into a pad on the pedal and contacts the clutch pedal bracket. Adjust the stop screw so that the pedal (when in the released position) has $\frac{1}{2}$ inch clearance with the bottom of the floor plate. Tighten the adjusting screw lock nut.

COAT CRANKSHAFT BUSHING WITH GREASE, GENERAL PURPOSE

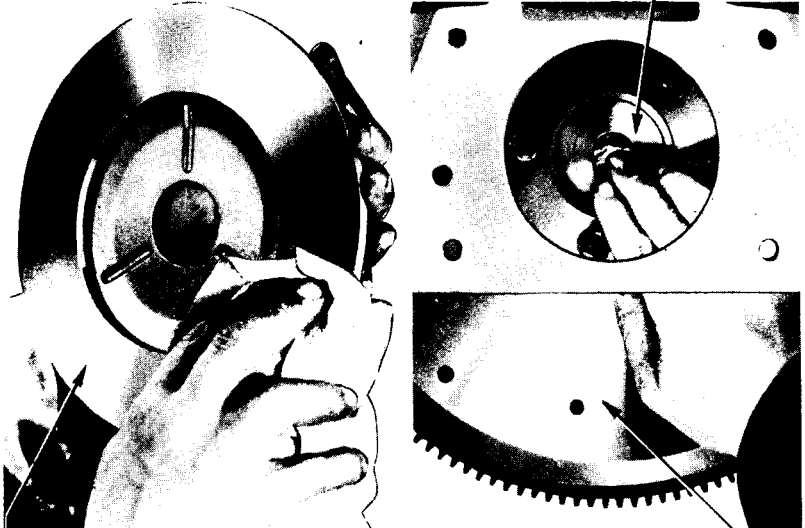

WIPE CONTACT SURFACES OF FLYWHEEL AND PRESSURE PLATE CLEAN

RA PD 52906

Figure 142—Cleaning Clutch Friction Surfaces and Lubricating Pilot Bushing

(3) **ADJUST PEDAL FREE PLAY** (fig. 141). Loosen the lock nut on the clutch operating rod. Push the clutch shaft lever forward to take up its free movement and adjust the yoke on the rod so that the pin will slide through the clutch operating shaft lever when the clutch pedal pad is held down $1\frac{1}{8}$ inches from its released position. (This operation can be facilitated if the pedal is held down $1\frac{1}{8}$ inches with a pedal jack.) Install the pin and cotter pin and tighten the yoke lock nut. The clutch pedal pad will then have $1\frac{1}{8}$ inch free movement from the released position to the point where the clutch starts to release.

3/4-TON 4 x 4 TRUCK (DODGE)**131. CLUTCH DISK AND RELEASE BEARING.****a. Removal.**

- (1) REMOVE TRANSMISSION (par. 133).
- (2) REMOVE CLUTCH RELEASE BEARING. Remove the six cap screws which hold the clutch housing pin. Disconnect the spring from the pull-back screw in the clutch housing and remove the clutch release bearing and sleeve.
- (3) REMOVE CLUTCH DISK. Remove the clutch cover to flywheel cap screws. Loosen the screws a turn or two at a time to avoid distorting the cover. Remove the clutch cover and pressure plate assembly and clutch disk from the clutch housing.

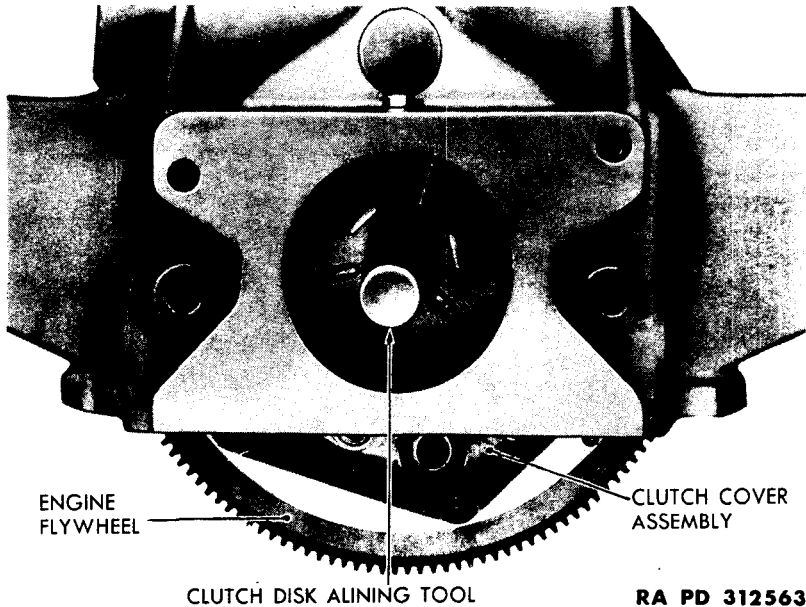
**Figure 143—Installation of Clutch Disk**

b. Cleaning of Parts (fig. 142). The clutch release bearing is packed with lubricant and sealed when manufactured and no further lubrication is required. **CAUTION:** *Never wash clutch release bearing in kerosene, gasoline, or other dry-cleaning solvent which would dissolve the lubricant in the bearing.* Keep oil and grease off friction surfaces of clutch parts to avoid chattering and grabbing of clutch.

c. Installation.

- (1) INSTALL CLUTCH DISK. Coat the bushing in the end of the crankshaft with general purpose grease No. 2 (fig. 142). Wipe the contact surfaces of the flywheel and pressure plate thoroughly with

CLUTCH

a clean dry cloth, to make certain that the surfaces are clean and free from oil. Hold the clutch cover and disk in place and install the cover attaching cap screws with lock washers, but do not tighten.

(2) **ALINE CLUTCH DISK** (fig. 143). Center the clutch disk with the clutch alining tool. Tighten the clutch cover cap screws, a turn or two at a time to avoid distorting the cover. Finally tighten the screws to 15 to 20 foot-pounds. Remove the clutch alining tool.

(3) **INSTALL CLUTCH RELEASE BEARING**. Install the clutch release bearing and sleeve and connect the spring to the pull-back spring screw in the clutch housing. Install the cap screws with lock washers for the clutch housing pan.

(4) **INSTALL TRANSMISSION** (par. 133).

(5) **ADJUST CLUTCH PEDAL FREE PLAY** (par. 130).

3/4-TON 4 x 4 TRUCK (DODGE)

Section XXVIII

TRANSMISSION AND POWER TAKE-OFF

	Paragraph
General description	132
Transmission	133
Power take-off control linkage	134

132. GENERAL DESCRIPTION.

a. The transmission is known as a four-speed, selective sliding gear type. Its purpose is to provide different gear ratios for forward motion of the vehicle and a means of reversing the motion of the vehicle. A power take-off assembly is mounted on the side of the transmission case and provides a means of taking power from the engine to operate the winch on the Weapon Carrier (model WC-52) and Command (model WC-57).

133. TRANSMISSION.

a. Removal of Transmission Assembly (fig. 144).

(1) **REMOVE FLOOR MAT (AMBULANCE ONLY).** Tilt the attendant's seat forward and remove the four cap screws from the seat support brackets. Raise the driver's seat to its highest position and tilt forward. Remove the seat adjusting mechanism to floor cap screws. Remove the cotter pin and pin from the accelerator pedal at the accelerator pedal rod. Remove the floor mat front section. Remove the center and two end linoleum retainer angles, remove the screws from the floor mat and lift out the mat.

(2) **REMOVE LEFT FLOOR PLATE.** Remove the clutch and brake pedal draft pads and retainers. Remove the left floor plate screws and lift out the floor plate.

(3) **REMOVE RIGHT FLOOR PLATE.** Disconnect the throttle control spring from the clip on the accelerator shaft to throttle bell crank rod, located under the hood at the right rear side. Remove the right floor plate screws and lift out the floor plate.

(4) **REMOVE CENTER FLOOR PANEL.** Remove the cotter pin and yoke pin from the shifter lever end plate, also the cotter pin from the shifter shaft eyebolt pin where it is attached at the power take-off control lever. Lower the control lever down through the opening in the floor panel. Remove the cotter pin and pin from the accelerator pedal rod at the pedal. Remove the center floor panel cap screws. Move the hand brake lever and transfer case control lever into position so that the center panel can be lifted out.

(5) **DISCONNECT WINCH DRIVE SHAFT.** Remove the lock wire and loosen the set screw which holds the drive shaft collar on the drive shaft just ahead of the splined yoke at power take-off. Remove the lock wire and loosen the set screw which holds the rear universal joint assembly on the power take-off drive shaft. Slide the collar and

TRANSMISSION AND POWER TAKE-OFF

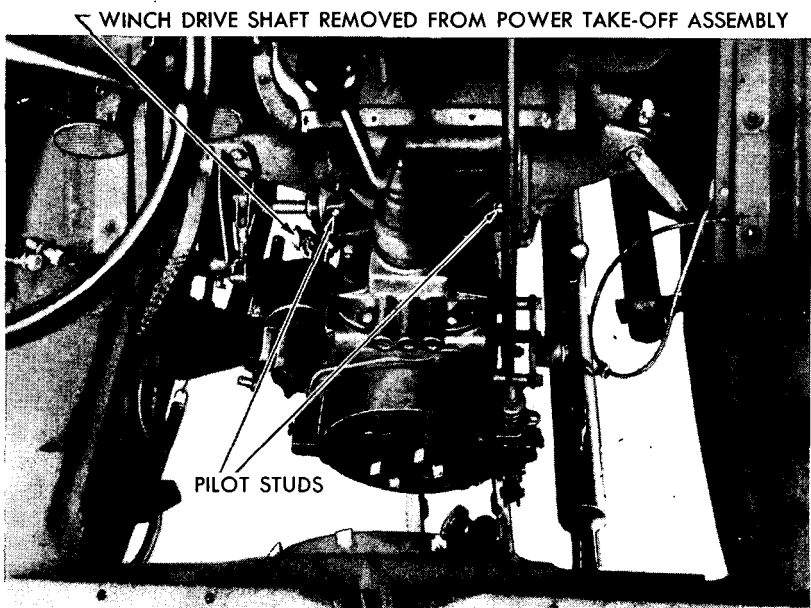
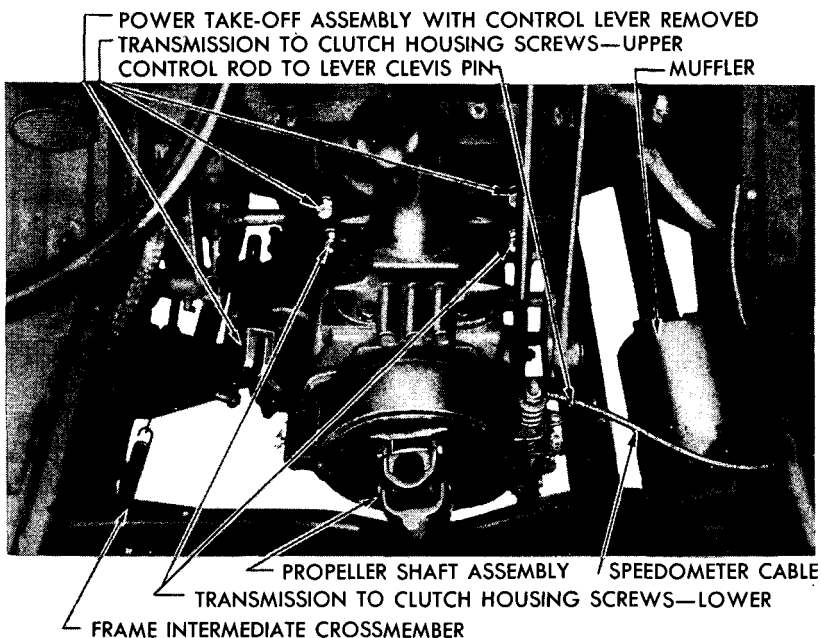

RA PD 312564

Figure 144—Removal of Transmission

3/4-TON 4 x 4 TRUCK (DODGE)

the universal joint assembly forward on the drive shaft. This will disengage the joint assembly from the power take-off drive shaft. Lower the shaft until it rests on the front axle housing.

(6) **DISCONNECT TRANSFER CASE CONTROL ROD AND SPEEDOMETER CABLE.** Remove the cotter pin from the transfer case control rod clevis pin at the transmission end and remove the clevis pin. Let the rod drop down out of the way. Disconnect the speedometer cable and housing assembly from the transmission.

(7) **LOOSEN FRAME CROSS MEMBER (EXCEPT AMBULANCE).** Remove the four bolts and nuts that attach the rear gusset to the intermediate frame cross member and left frame side rail. Also remove the two cross member to front gusset bolts and nuts. Remove the two bolts and nuts that attach the cross member to the upper flange of the left frame side rail. Remove the two bolts and nuts that attach the cross member to the upper flange of the right frame side rail. Remove the two large bolts and nuts from cross member to right frame side rail. Move the cross member toward the rear axle as far as possible.

(8) **DISCONNECT PROPELLER SHAFT.** Open the universal joint clamp bolt nut locks. Remove the nuts from the universal joint clamp bolts. Remove the bolts and locks, then the universal joint clamps. Slide the splined yoke on the shaft as far as it will go to disengage from transmission.

(9) **REMOVE TRANSMISSION.** Remove the two upper transmission to clutch housing cap screws. Insert pilot studs in the two upper holes and screw studs in place. (Pilot studs can be made by sawing the heads from two $\frac{9}{16}$ inch—12 x $1\frac{3}{4}$ inch—cap screws and slotting the ends with a hack saw so that a screwdriver can be used to screw the studs in place.) Remove the two lower cap screws which hold the transmission to the clutch housing. Place a jack under the transmission to support it and move the transmission rearward sufficiently to pull the transmission main drive pinion out of the clutch disk. Lower transmission to the floor. Care must be exercised to prevent transmission dropping down and springing the clutch assembly.

b. Installation of Transmission Assembly (fig. 144).

(1) **INSTALL TRANSMISSION.** Use the pilot studs installed when the transmission was removed to help guide the main drive pinion straight through the clutch disk hub splines and into the pilot bushing in the end of the crankshaft. Support the transmission with a jack to prevent damaging the clutch assembly. Install the lower transmission to clutch housing cap screws with lock washers and tighten. Remove the two pilot studs from the upper holes. Install the cap screws with lock washers and tighten.

(2) **CONNECT PROPELLER SHAFT.** Place the universal joint clamps in position, install the clamp bolt locks on the bolts and install the bolts in the universal joint. Place new clamp bolt nut locks on the bolts, then install the nuts and tighten to 20 to 25 foot-pounds. Bend over the lugs of all the clamp bolt locks and nut locks.

TRANSMISSION AND POWER TAKE-OFF

(3) **ATTACH FRAME CROSS MEMBER (EXCEPT AMBULANCE).** Move the cross member into position and insert the four small bolts which attach the cross member to the upper flanges of the frame side rails. Install lock washers and nuts but do not tighten the nuts. Assemble the rear cross member to frame gusset to the cross member with two of the large bolts and nuts with lock washers, also the two large bolts and nuts with lock washers, to attach the cross member to the front gusset. Install the two rear gussets to frame side rail bolts and nuts with lock washers, also the two large bolts and nuts with lock washers, attaching the cross member to the right frame side rail. Tighten all bolts and nuts securely.

(4) **CONNECT SPEEDOMETER CABLE AND TRANSFER CASE CONTROL ROD.** Insert the speedometer cable drive shaft in the transmission main shaft rear bearing retainer. Make sure the cable engages with the drive pinion before the retaining nut is screwed into place. Tighten the cable housing nut. Attach the transfer case control rod to the control lever on the transmission and insert the clevis pin. Lock the clevis pin with a cotter pin.

(5) **CONNECT WINCH DRIVE SHAFT.** Make sure the power take-off drive shaft key is in place. Slide the drive shaft joint assembly onto the power take-off drive shaft. Tighten set screw which holds the universal joint assembly on the power take-off drive shaft. Place a new wire through the head of the set screw and lock it around the joint. Set the drive shaft collar from $\frac{3}{8}$ to $\frac{1}{2}$ inch ahead of the splined yoke. Tighten the set screw. Place a new wire through the head of the set screw and lock it around the collar.

(6) **FILL TRANSMISSION WITH LUBRICANT.** Remove the transmission filler plug and fill the transmission to $\frac{1}{2}$ inch below the level of filler hole with universal gear lubricant (par. 24). Use seven pints if vehicle is equipped with power take-off and $5\frac{1}{2}$ pints if not equipped with power take-off. Install filler plug.

(7) **INSTALL CENTER FLOOR PANEL.** Lower the center floor panel into position over gearshaft lever, hand brake, and transfer case levers. Install the cap screws with toothed lock washers and tighten. Slide the end of the power take-off control lever up through the opening in the center floor panel and hold it in position. Install the yoke pin and cotter pin at the shifter lever end plate, also the cotter pin with plain washer in the shifter shaft eyebolt pin. Install the pin and cotter pin which attach the accelerator pedal to the accelerator pedal rod.

(8) **INSTALL RIGHT FLOOR PLATE.** Lay the right floor plate in place and install the screws with toothed lock washers. Connect the throttle control spring to the clip on the accelerator shaft to throttle bell crank rod.

(9) **INSTALL LEFT FLOOR PLATE.** Lay the left floor plate in place and install the screws with toothed lock washers. Install the clutch and brake pedal draft pads and pad retainers. Tighten the screws with toothed lock washers.

3/4-TON 4 x 4 TRUCK (DODGE)

(10) **INSTALL FLOOR MAT (AMBULANCE ONLY).** Place the rear section of the floor mat in position and install the screws with plain washers. Install the center and two end linoleum retainer angles. Work the front section of the floor mat into place so that the openings in the mat will slide down over the gearshift, hand brake, transfer case levers, and accelerator pedal. Attach the accelerator pedal to the accelerator pedal rod. Install floor mat screws. Position the driver's seat so that it is raised to its highest position and install the cap screws with lock washers. Install the one short cap screw in the right rear screw hole of the seat adjusting mechanism. Place the attendant's seat in position in the cab and tilt it forward. Install the seat support bracket cap screws with lock washers.

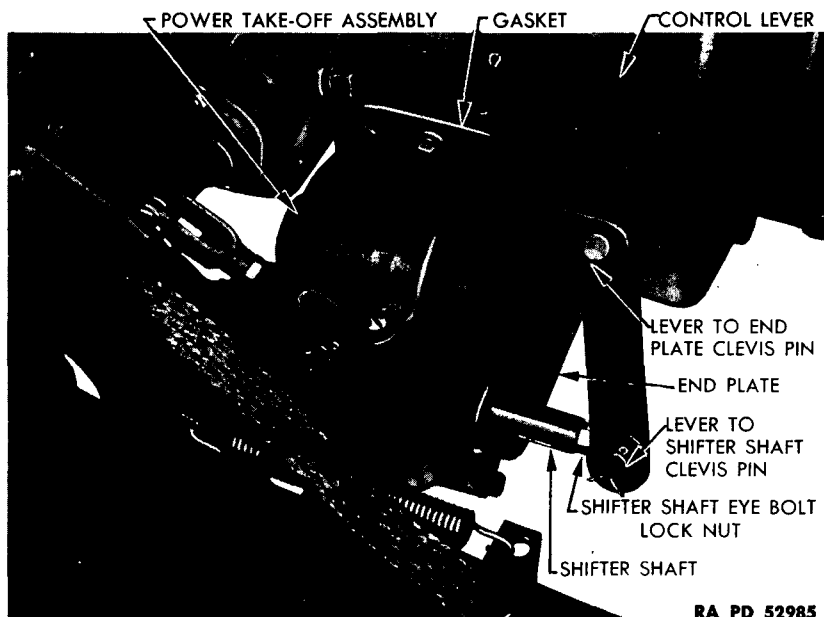

RA PD 52985

Figure 145—Power Take-off Control Lever and Linkage

134. POWER TAKE-OFF CONTROL LINKAGE.

a. **Removal of Control Lever** (fig. 145). Remove the cotter pin and clevis pin from the control lever end plate, also the cotter pin from the shifter shaft clevis pin where it is attached at the power take-off control lever. Pull the control lever down through the opening in the floor panel.

b. **Installation of Control Lever** (fig. 145). Slide the end of the power take-off control lever up through the opening in the center floor panel and hold it in position. Install the clevis pin and cotter pin at the control lever end plate, also the cotter pin with plain washer in the shifter shaft clevis pin.

TRANSMISSION AND POWER TAKE-OFF**c. Adjustment of Control Lever Linkage (fig. 145).**

(1) Whenever the control lever is replaced, adjust the location of the neutral position control lever lock on the center floor panel or the eyebolt in the end of the shifter shaft so that the power take-off will be in neutral, and the shifter shaft poppet ball indexed with the indent in the shifter shaft when the control lever is locked in the neutral position.

(2) If the control lever lock cannot be locked without moving the control lever out of the neutral position, loosen the control lever lock cap screws, and move the lock forward or to the rear on the elongated holes. Adjustment can also be made at the shifter shaft eyebolt. Remove control lever. Loosen eyebolt lock nut. Turn eyebolt clockwise to adjust control lever rearward and counterclockwise to adjust control lever forward. Tighten lock nut and install control lever.

3/4-TON 4 x 4 TRUCK (DODGE)

Section XXIX

TRANSFER CASE

	Paragraph
General description	135
Control lever and linkage	136
Transfer case assembly	137

135. GENERAL DESCRIPTION.

a. The transfer case is located back of the transmission. It is connected with the transmission by means of a short propeller shaft through which power is transmitted from the engine. The transfer case transmits the engine power to the front and rear axles by means

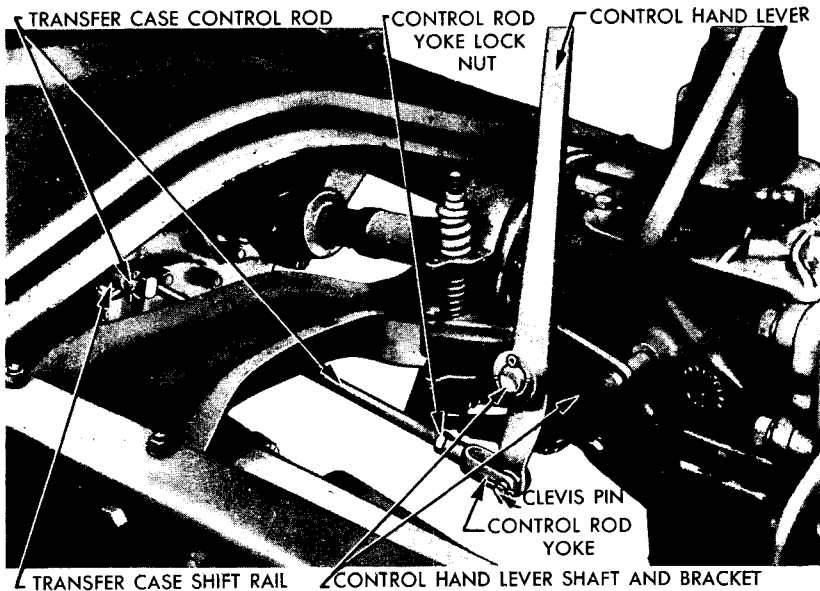

RA PD 52987

Figure 146—Transfer Case Control Lever and Linkage

of the propeller shafts. It is in constant mesh for transmitting power to the rear axle and a means is provided whereby the drive to the front axle can be engaged or disengaged by a control lever in the driver's compartment (par. 5).

136. CONTROL LEVER AND LINKAGE.

a. **Removal** (fig. 146). Remove the cotter pin and clevis pin from the front end of the control rod yoke at the control rod hand

TRANSFER CASE

lever and the cotter pin from the transfer case control rod at the transfer case. Remove the cotter pin from the control lever bracket shaft. Remove three cap screws that hold the control lever bracket to the transmission. Lower lever and bracket and slide lever off bracket. Loosen the control rod yoke lock nut and unscrew the yoke from the rod.

b. Installation (fig. 146). Insert the control rod end in the shift rail at the transfer case and install the cotter pin. Screw the yoke on the control rod up to the lock nut. Slide the control lever onto the control lever bracket shaft. Install the three cap screws and lock washers that hold control lever bracket to transmission. Place the plain washer on the shaft and install the cotter pin. Position the control lever with the control rod yoke and install the clevis pin.

c. Adjustment of Linkage.

(1) When the control hand lever is shifted to the engaged or disengaged positions, the shift rail poppet ball must index with the indent on the shift rail to prevent disengagement of the front axle drive. If the control lever can be shifted to the engaged or disengaged positions without the control lever striking the ends of the lever opening in the floor panel, the adjustment is satisfactory.

(2) To adjust, loosen the lock nut, remove the cotter pin and clevis pin from the yoke at the control lever. Then turn the yoke on the control rod clockwise to shorten the rod, or counterclockwise to lengthen the rod for correct adjustment of control lever. Install clevis pin and cotter pin and tighten lock nut.

137. TRANSFER CASE ASSEMBLY.

a. Transfer Case Misalignment. The transfer case may become misaligned due to severe shock, contact with stumps, stones, banks of streams, or other obstructions. Transfer case misalignment often causes the propeller shaft spline to be partially withdrawn from the propeller shaft companion yoke spline, causing propeller shaft whip and/or destructive wear of the propeller shaft splines and propeller shaft compound yoke splines.

(1) **CHECKING MISALIGNMENT.** Transfer case misalignment may be determined by measuring the front propeller shaft from the center of the rear universal joint cross bearing to the center of the front universal joint cross bearing. The correct measurement is 34 inches. If the dimension varies more than plus $\frac{1}{4}$ inch or minus $\frac{1}{8}$ inch, check the front axle for alinement (par. 141). If the front axle alinement is correct, the transfer case is misaligned. Notify higher authority.

b. Removal.

(1) **DISCONNECT PROPELLER SHAFTS.** Open the universal joint clamp bolt nut locks. Remove the nuts from the universal joint clamp bolts. Remove the bolts and locks, then the universal joint clamps.

(2) **DISCONNECT CONTROL ROD.** Remove cotter pin from the transfer case control rod at the transfer case, and the cotter pin and clevis pin from the control lever end of the control rod.

3/4-TON 4 x 4 TRUCK (DODGE)

(3) **REMOVE TRANSFER CASE.** Remove the lock wires from the four cap screws which attach the transfer case to the mounting brackets. Support the transfer case with jack to prevent personal injury. Remove the four transfer case to mounting bracket cap screws.

c. Installation.

(1) **INSTALL TRANSFER CASE.** Place the transfer case under the vehicle and raise it into position with jack. Install the transfer case to frame bracket cap screws and lock washers. Lock the screws in place with a piece of wire.

(2) **CONNECT PROPELLER SHAFTS TO TRANSFER CASE.** Place the universal joint clamps in position, then install the clamp bolt locks on the bolts, and install the bolts in the universal joint. Place new clamp bolt nut locks, then install the nuts and tighten to 20 to 25 foot-pounds. Bend over the lugs of all the clamp bolt and nut locks.

(3) **CONNECT CONTROL ROD.** Insert the control rod end in the shift rail and install the cotter pin. If it is necessary to adjust the control rod, refer to paragraph 134 for procedure.

(4) **FILL TRANSFER CASE WITH LUBRICANT.** Remove the transfer case filler plug and fill with lubricant to $\frac{1}{2}$ inch below filler opening, with transfer case and lubricant at room temperature (70°F) (par. 24). Do not overfill, as this will cause overheating and leakage of lubricant.

Section XXX

PROPELLER SHAFTS

	Paragraph
General description	138
Propeller shafts	139

138. GENERAL DESCRIPTION.

a. Three propeller shafts are used in each vehicle: One extends from the transmission to the transfer case; one from the transfer case to the rear axle; one from the transfer case to the front axle. Each propeller shaft has one universal joint that slides on the splined end of the shaft, and one that is welded to the other end of the shaft (fig. 147).

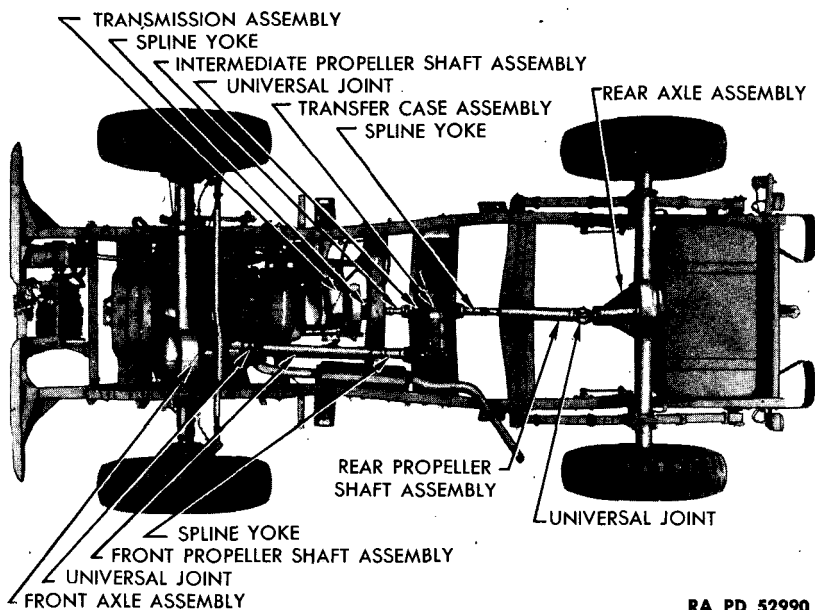

RA PD 52990

Figure 147—Propeller Shafts and Universal Joints

139. PROPELLER SHAFTS.

a. **Removal** (fig. 148). Open the universal clamp bolt nut locks. Remove the nuts from the universal joint clamp bolts. Remove the bolts and locks, then the universal joint clamps. Open the universal clamp bolt nut locks on the universal joint at the other end of the shaft. Remove the nuts from the universal joint clamp bolts. Remove the bolts and locks, then the universal joint clamps. Remove the assembly from the vehicle.

3/4-TON 4 x 4 TRUCK (DODGE)

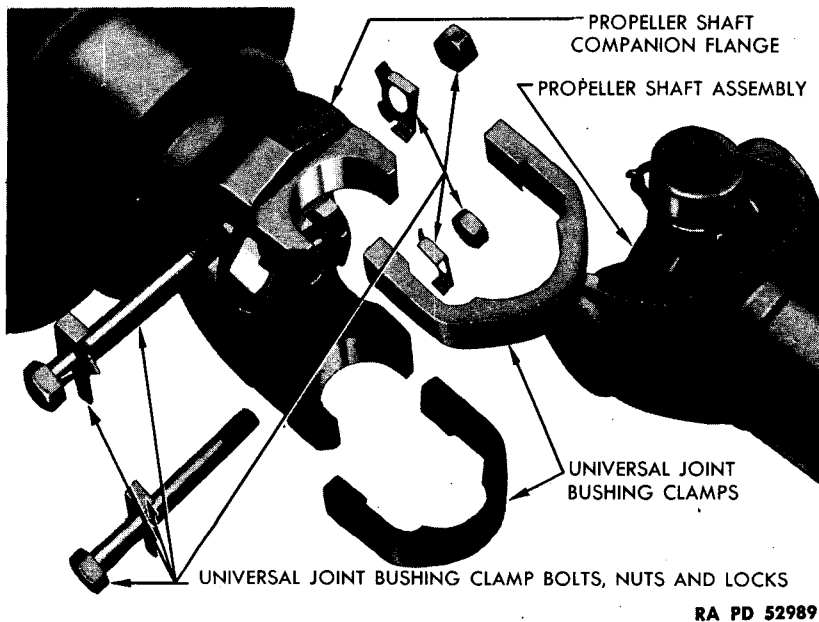

Figure 148—Disconnecting Propeller Shaft

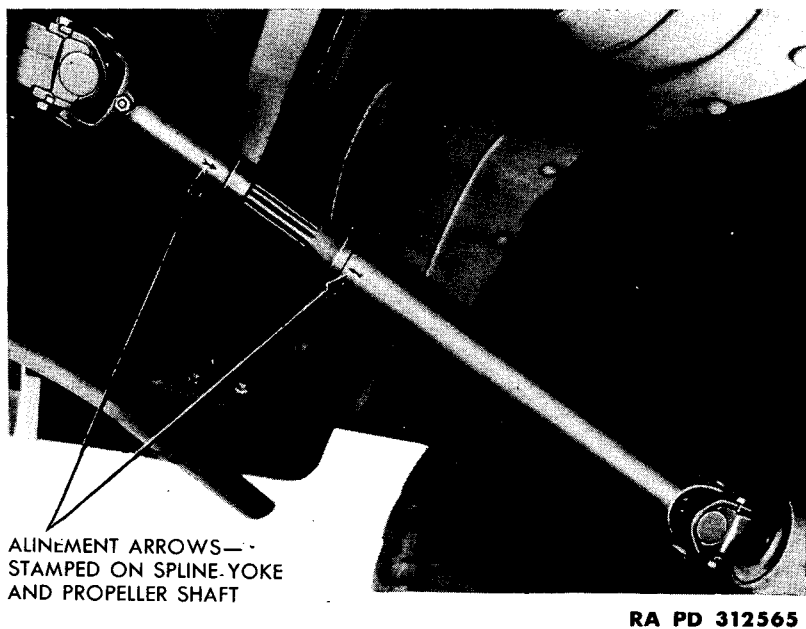

Figure 149—Propeller Shaft Alinement Arrows

PROPELLER SHAFTS

b. Installation.

(1) **INSTALL SPLINE YOKE** (fig. 149). Coat the splines of the propeller shaft with general purpose grease and slide the universal joint and spline yoke assembly onto the propeller shaft. Make sure that the two arrows, one on the splined yoke and the other on the propeller shaft, point directly toward each other so that the yokes at the ends of the propeller shaft are in alignment. If the yokes are not aligned with each other, failure of the joints or shaft will result.

(2) **INSTALL UNIVERSAL JOINT CLAMPS** (fig. 148). Lift the propeller shaft assembly in place. Place the universal joint clamps in position. Install the clamp bolt locks on the bolts and install the bolts in the universal joint. Place the clamp bolt nut locks on the bolts, then install the nuts and tighten to 20 to 25 foot-pounds. Bend over the lugs of all the clamp bolt locks and nut locks.

3/4-TON 4 x 4 TRUCK (DODGE)

Section XXXI

FRONT AXLE

	Paragraph
General description	140
Front wheel alinement	141
Front wheel bearings	142
Universal drive shaft bushings and oil seals	143
Steering arm and tie rod	144
Front axle assembly	145

140. GENERAL DESCRIPTION.

a. The front axle as well as the rear axle is a driving unit. The front axle drive shafts have universal joints at the steering knuckles through which power is transmitted to the wheels. It is of the full-floating type so that only the torque or driving power is carried by the axle drive shafts. The differential and carrier assembly in the front axle is identical with that used in the rear axle.

b. The differential lubricant is confined to the differential and drive pinion sections of the axle housing by the drive pinion bearing oil slinger, the drive pinion oil seal, and the universal drive shaft oil seal. The universal drive shaft joint lubricant is retained in the universal joint and steering knuckle housings by the trunnion socket bushing and the steering knuckle bushing. Wheel bearing lubricant is retained by the front wheel bearing oil seal.

141. FRONT WHEEL ALINEMENT.

a. **General.** Front wheel alinement is governed by four factors commonly known as camber, king pin angle, caster, and wheel toe-in.

(1) **CAMBER AND KING PIN ANGLES.** The correct camber and king pin angles are built into the front axle and will change only if the axle housing or steering knuckles are distorted by accidental damage. Therefore, no adjustments are provided.

(2) **CASTER.** Caster is governed by the chassis springs and the mounting of the front axle to the front springs. Correct caster is established by design and will be changed only by shifting of the front axle on the springs or by distortion of the chassis frame or springs or by the use of caster shims. No adjustment of caster is provided.

(3) **TOE-IN.** Front wheel toe-in is the most important factor in front wheel alinement. It is governed by the angle of the steering knuckle arms and the length of the steering tie rod. Inasmuch as wheel toe-in can be accidentally altered without serious damage to the vehicle, an adjustment is provided so that the tie rod may be lengthened or shortened to maintain correct front wheel toe-in of 0 to 1/8 inch (1/16 in. preferred).

FRONT AXLE

b. Checking and Adjusting Toe-in.

(1) **CHECK TOE-IN** (fig. 150). With the front wheels in a straight forward position, move the vehicle at least three feet forward to get the tires in free rolling condition. Place the wheel alinement gage between the tires forward of the axle with both pendant chains barely touching the floor. Set the scale so that the pointer registers with zero. Move the vehicle forward until the gage is back of the axle with the pendant chains barely touching the floor, and read the gage. The amount the scale has moved in relation to the pointer will indicate the amount of wheel toe-in or toe-out. Since toe-out is never desirable, the gage is calibrated in inches for toe-in only.

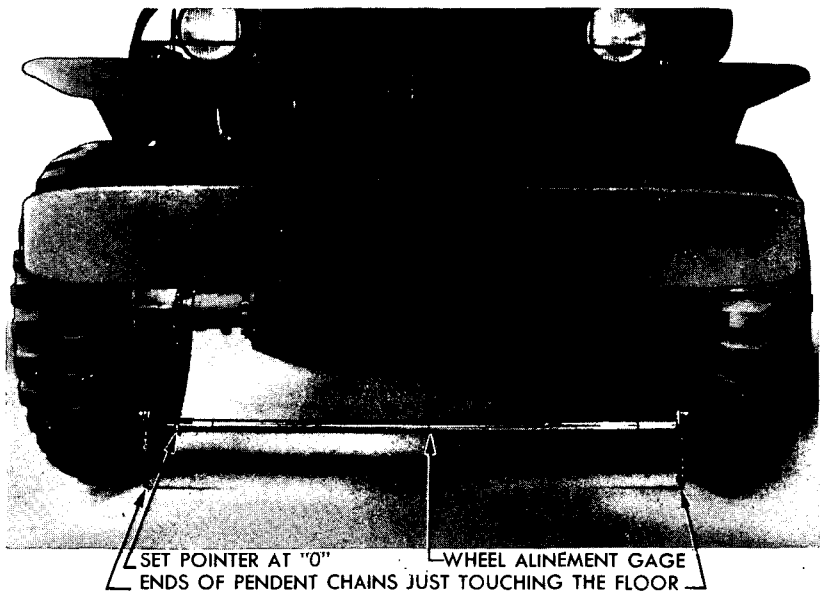

RA PD 52992

Figure 150—Front Wheel Toe-in Adjustment

(2) **ADJUST TOE-IN** (fig. 151). Remove cotter pin and nut which hold the left tie rod end to the steering knuckle arm. Insert a pinch bar between the tie rod end and the arm and strike the arm with a hammer. Loosen tie rod end clamp bolt. Turn tie rod end clockwise to shorten tie rod and decrease toe-in, or counterclockwise to lengthen tie rod and increase toe-in. After each adjustment of tie rod length, install tie rod end to the steering knuckle arm, and recheck the wheel toe-in. When correct toe-in adjustment has been made, tighten the tie rod clamp bolt. Install nut and cotter pin which hold the tie rod end to the steering knuckle arm, and tighten securely.

3/4-TON 4 x 4 TRUCK (DODGE)

c. Front Wheel Turning Radius.

(1) **GENERAL.** Ability to maneuver the vehicle in close quarters and the life of the front axle universal drive assemblies depend upon correct turning radius being maintained. It is desirable that a vehicle turn in as small a circle as is practicable; however, if the inside wheel (when on a turn) is turned more than 28 degrees from a straight forward position, the front axle universal drive assemblies may be damaged. Turning radius is governed by stop screws which are adjusted, then tack-welded, to the steering knuckle arms. If inspection shows the screw to be loose or missing, notify higher authority.

BACK OFF NUT BUT DO NOT REMOVE UNTIL TIE ROD END HAS BEEN PRIED LOOSE

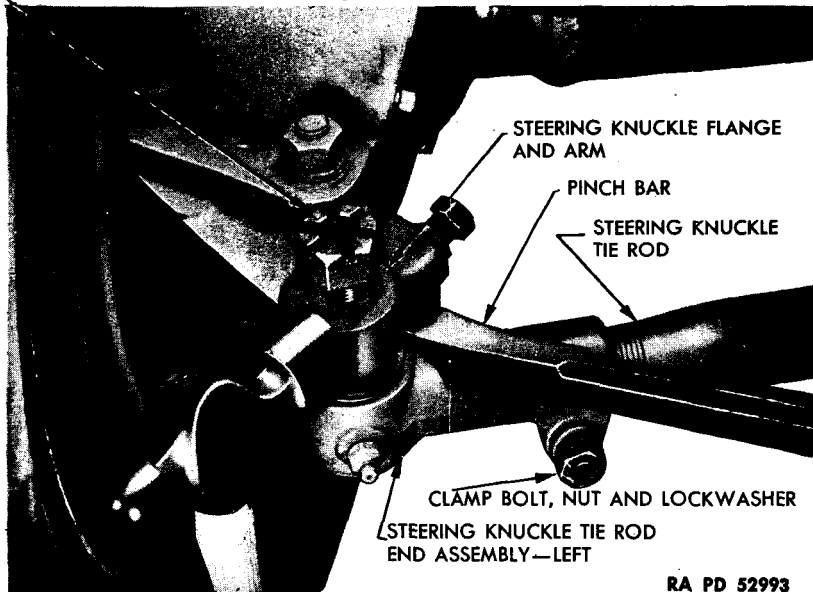

RA PD 52993

Figure 151—Removing Steering Knuckle Tie Rod End

142. FRONT WHEEL BEARINGS.

a. Adjustment of Front Wheel Bearings.

(1) **REMOVE DRIVE FLANGE FROM WHEEL HUB** (fig. 152). Place a jack under the axle housing and raise wheel until tire clears the ground. Remove the six stud nuts which hold the drive flange to the wheel hub. Remove two flange puller screws from a rear axle shaft flange, remove the lock nuts from the screws, and use the screws to pull the drive flange off the hub.

(2) **ADJUST BEARINGS** (fig. 153). Remove the wheel bearing outer adjusting nut and the adjusting nut lock. Turn the inner adjusting nut tight to seat the bearings and then back it off about one-sixth of a turn. Wheel should rotate freely with no end play. Install the

FRONT AXLE

adjusting nut lock, making sure that the dowel pin in the inner adjusting nut enters a hole in the lock. It may be necessary to turn the lock over or even turn the inner adjusting nut slightly to permit the dowel pin to enter one of the holes in the lock. With the lock over the dowel pin, install the outer adjusting nut and tighten it securely.

(3) **INSTALL DRIVE FLANGE.** Remove flange puller screws from flange and install the screws and lock nuts in rear axle drive shaft flange. Place the drive flange over the splines of the drive shaft and over the studs in the wheel hub. Install the flange attaching nuts with a standard lock washer back of each nut and tighten the nuts securely. Remove the jack from under axle housing.

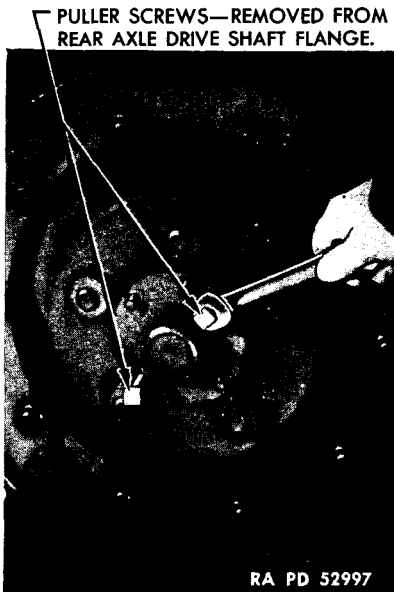

Figure 152—Removing Drive Flange

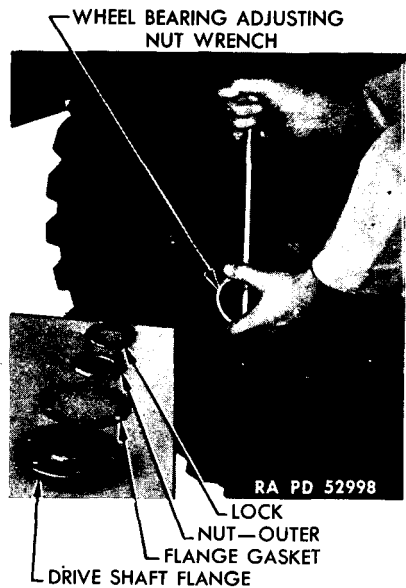

Figure 153—Adjusting Front Wheel Bearing

b. Removal of Front Wheel Bearings and Oil Seal. Before removing the wheel bearings or oil seals, put a new wheel bearing oil seal in thin oil and allow it to soak while the following operations are being performed.

- (1) **JACK UP WHEEL.** Raise wheel with jack and place stand under axle housing.
- (2) **REMOVE AXLE DRIVE FLANGE** (subpar. a (1) above).
- (3) **REMOVE WHEEL AND TIRE ASSEMBLY** (par. 163).
- (4) **REMOVE WHEEL HUB AND BEARINGS** (fig. 154). Turn the brake shoe adjusting cams to increase the clearance between the brake shoes and the drums (par. 151). Remove wheel bearing outer

3/4-TON 4 x 4 TRUCK (DODGE)

adjusting nut, adjusting nut lock, and inner adjusting nut with wheel bearing adjusting nut wrench. Remove the wheel outer bearing and pull drum, hub, and wheel inner bearing from steering knuckle.

(5) REMOVE OIL SEAL, CONE AND CUPS (fig. 154). Remove wheel bearing oil seal snap ring from inner end of hub. Remove wheel bearing inner cone and oil seal from hub by driving against the hub of the bearing cone. Drive inner and outer bearing cups from hub.

c. Installation of Front Wheel Bearings and Oil Seals.

(1) INSTALL WHEEL BEARINGS AND OIL SEAL (figs. 155 and 156). Install inner and outer bearing cups in hub, thick edge first. Pack

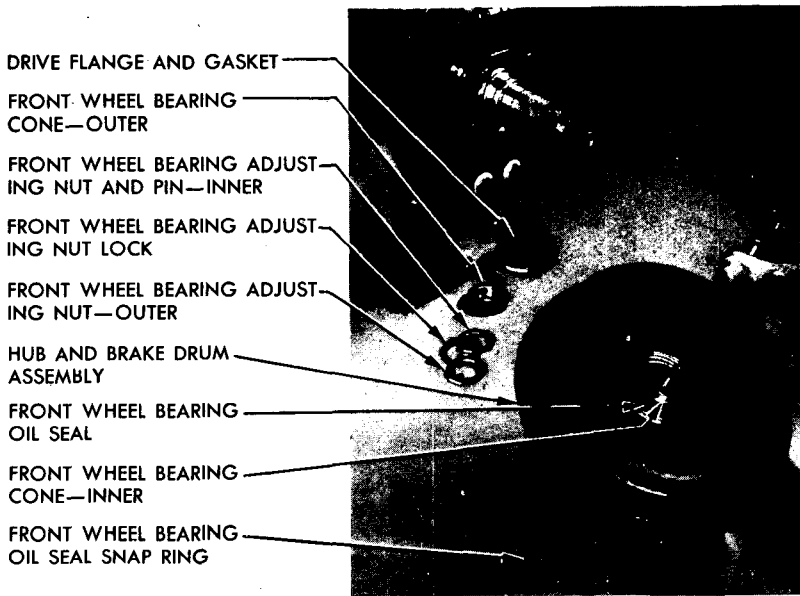

Figure 154—Removing Front Wheel Inner Bearing and Oil Seal

the wheel inner bearing cone with wheel bearing grease and place the bearing cone in the bearing cup. Work the oil seal, after soaking in thin oil, by rolling with pressure applied by a smooth bar. Drive the seal in the hub with oil seal drift just far enough so that the oil seal snap ring can be installed, to prevent interference with the bearing.

(2) INSTALL HUB AND DRUM AND ADJUST BRAKE SHOES. Clean the steering knuckle and inspect the oil seal bearing surface. Remove any roughness that may exist on that surface. Slide the hub and drum straight onto the steering knuckle. Exercise care to prevent damage to oil seal. Pack the outer bearing cone with wheel bearing grease and install the bearing and inner bearing adjusting nut on the steering knuckle. Adjust the wheel bearings (subpar. a (2) above). Turn brake

FRONT AXLE

shoe adjusting cams until brake drags and then back off just enough to free the drum.

- (3) INSTALL WHEEL AND TIRE ASSEMBLY (par. 163).
- (4) INSTALL AXLE DRIVE FLANGE (subpar. a (3) above).

143. UNIVERSAL DRIVE SHAFT, BUSHINGS, AND OIL SEALS.

a. Removal.

- (1) REMOVE WHEEL AND TIRE ASSEMBLY (par. 163).
- (2) REMOVE HUB AND DRUM; CHECK END PLAY IN UNIVERSAL DRIVE. Turn the tops of the brake shoe adjusting cams toward each



Figure 155—Conditioning Oil Seal



Figure 156—Installing Wheel Bearing Oil Seal with Drift 41-D-1535-50

other to increase the clearance between the shoes and drums. Remove the nuts which hold the drive flanges to the hubs and install puller screws. Pull the flanges from the hubs and remove the wheel bearing outer adjusting nuts and adjusting nut locks. Remove the inner adjusting nuts and outer bearings and pull the hubs from the steering knuckles. Check end play in universal drive assembly. If the end play exceeds 0.059 inch, replace the housing bushing and the steering knuckle bushing.

3/4-TON 4 x 4 TRUCK (DODGE)

(3) REMOVE UNIVERSAL DRIVE ASSEMBLY (fig. 157). Remove five cap screws which hold the brake support and steering knuckle to the steering knuckle flange. Lay the brake support to rear of axle without damaging the brake hose. Tap the steering knuckle with hammer and pull it off. Pull the universal drive assembly, keeping it as straight as possible. *If the joint is allowed to flex excessively, it may fall apart.* If the inner drive shaft is broken between the oil seal and four inches from the differential, fish the inner piece out with a wire snare. If breakage is within four inches of differential, remove differential carrier assembly and remove broken piece.

(4) REMOVE OIL SEALS AND BUSHINGS. Pull the trunnion socket bushing and drive shaft oil seal located in the housing assembly with



Figure 157—Removing Universal Drive Assembly

a slide hammer type puller (41-P-2957). Drive the bushing out of the steering knuckle with a drift and hammer.

(5) REMOVE STEERING KNUCKLE FLANGE OIL SEAL (fig. 158). Remove cap screws which hold the oil seal retainer to the steering knuckle flange and pull the felt seal and pressure spring out of the retainer. Twist the retainer open at the joint and remove it from the axle housing.

b. Cleaning and Inspection of Universal Drive Assembly. Clean the joint thoroughly in dry-cleaning solvent to remove all traces of

FRONT AXLE

STEERING KNUCKLE FLANGE
OIL SEAL RETAINER

STEERING KNUCKLE FLANGE
OIL SEAL FELT

STEERING KNUCKLE FLANGE
OIL SEAL FELT PRESSURE
SPRING

STEERING KNUCKLE FLANGE
JOINT OIL SEAL FELT
AND RETAINER

STEERING KNUCKLE FLANGE
OIL SEAL GASKET

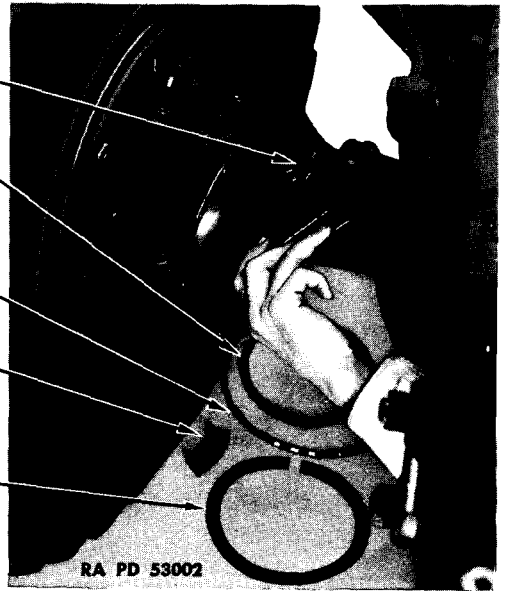
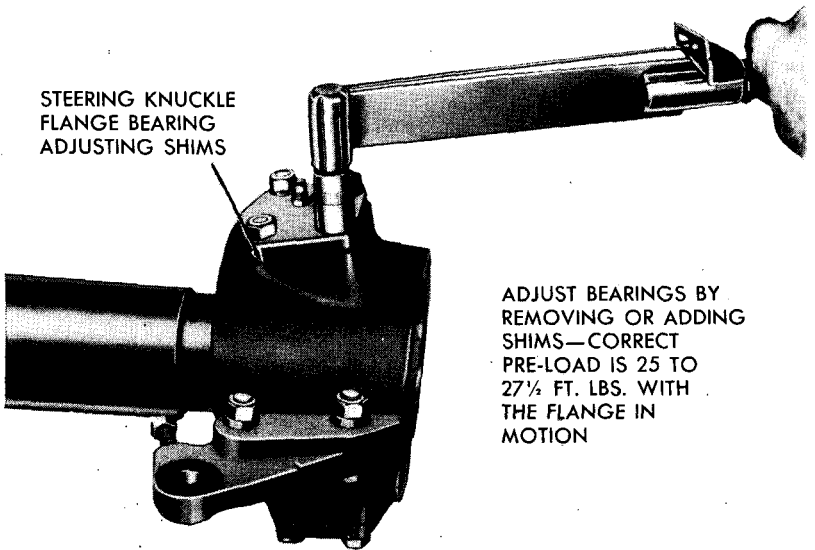

Figure 158—Removing Steering Knuckle Flange Oil Seal Retainer

STEERING KNUCKLE
FLANGE BEARING
ADJUSTING SHIMS



ADJUST BEARINGS BY
REMOVING OR ADDING
SHIMS—CORRECT
PRE-LOAD IS 25 TO
27½ FT. LBS. WITH
THE FLANGE IN
MOTION

RA PD 312579

Figure 159—Adjusting Steering Knuckle Flange Bearing

3/4-TON 4 x 4 TRUCK (DODGE)

old lubricant. Clamp one end of the assembly in a vise. Push the two sections of the joint together and twist the section not clamped in the vise to determine if any play exists between the races and drive balls. If any play is evident, notify higher authority.

c. Adjustment of Steering Knuckle Flange Bearings (fig. 159). With all parts removed as outlined in subparagraph a above, remove steering tie rod (par. 144 e) and disconnect steering drag link (par. 169 b). Make sure that bearing caps and bearings are seated by tapping with a hammer. Check the preload of the bearings with a foot-pound torque wrench attached to one of the cap screws of the

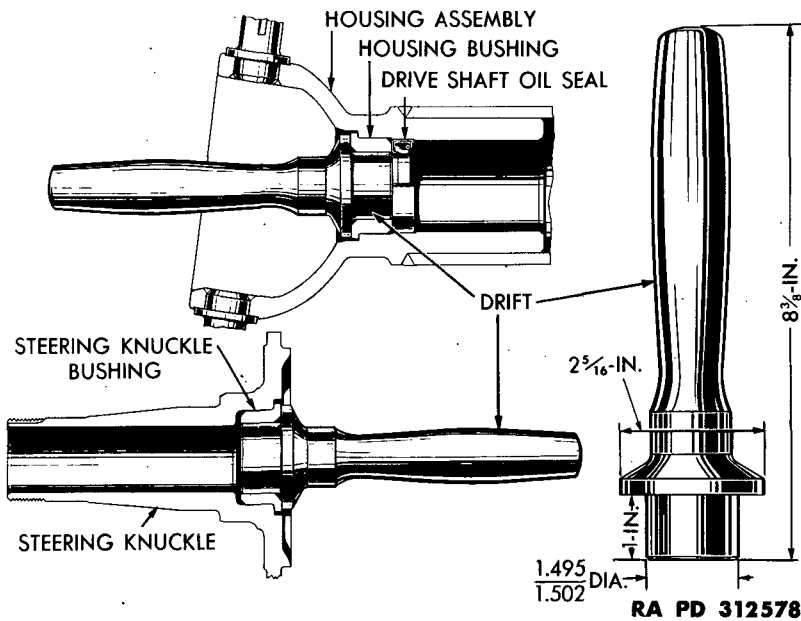

Figure 160—Installation of Oil Seal and Bushing with Drift 41-D-1535-25

steering knuckle flange bearing cap. The torque wrench reading should be from 25 to $27\frac{1}{2}$ foot-pounds while the flange is in motion. If the preload is not within specifications, remove or add shims between the top bearing cap and the steering knuckle flange. Remove shims to tighten or add shims to loosen the bearings. When the adjustment is completed, connect steering drag link (par. 169 d), and install steering tie rod (par. 144 d).

d. Installation.

(1) **INSTALL OIL SEALS AND BUSHINGS (fig. 160).** Drift the oil seal and bushing into the front axle housing with special drift

FRONT AXLE

(41-D-1535-25). Use same drift to install bushing in steering knuckle.

(2) **INSTALL STEERING KNUCKLE FLANGE OIL SEAL** (fig. 158). Clean the sealing surfaces and the seal retainer. Install the pressure spring in the retainer so that the ends of the spring are even with the ends of the retainer. Soak the felt seal in light oil and install it in the retainer with the ends even with the ends of the retainer. Twist the retainer open at the joint and put it over the axle housing. Place a new felt on the joint seal retainer and a new gasket on the steering knuckle flange. Install the seal assembly with the joint seal retainer at the top. Tighten the cap screws evenly to avoid distorting the retainer.



Figure 161—Removing Steering Arm

Figure 162—Installing Tie Rod Dust Cover

(3) **INSTALL UNIVERSAL DRIVE ASSEMBLY** (fig. 157). Pack the universal joint with lubricant and install the assembly with the long shaft first, being careful to insert the shaft through the drive shaft oil seal without damaging the oil seal. Install the steering knuckle, then the brake support assembly and lubricate the steering knuckle flange through the lubricant fitting (par. 24).

- (4) **INSTALL HUB AND DRUM ASSEMBLY** (par. 142 c (2)).
- (5) **INSTALL WHEEL AND TIRE ASSEMBLY** (par. 163).
- (6) **INSTALL AXLE DRIVE SHAFT FLANGE** (par. 142 a (3)).

3/4-TON 4 x 4 TRUCK (DODGE)

144. STEERING ARM AND TIE ROD.

a. Removal of Steering Arm.

- (1) DISCONNECT DRAG LINK FROM STEERING ARM (par. 169).
- (2) REMOVE STEERING ARM (fig. 161). Remove four cap screws which hold the steering arm to the flange and raise arm off the flange. Be sure to leave all the adjusting shims on the steering knuckle flange.

b. Installation of Steering Arm.

- (1) INSTALL STEERING ARM (fig. 161). Place the arm over the steering knuckle flange bearing shims, making sure all original shims are in place. Install the four attaching cap screws with toothed lock washer under head of each cap screw.
- (2) CONNECT DRAG LINK TO STEERING ARM (par. 169).

c. Removal of Steering Tie Rod (fig. 151). Remove cotter pins and two nuts which hold tie rod ends to the steering knuckle arms. Insert pinch bar between tie rod end and steering knuckle and strike the steering knuckle arm with hammer. Loosen clamp bolt nut and screw tie rod ends off tie rod.

d. Installation of Steering Tie Rod (fig. 162). Screw the tie rod ends onto tie rod, leaving about six threads exposed at the left end of the tie rod, and about 10 threads exposed at the right end of the tie rod. Place the dust washers, covers, and springs over the ball studs. Insert tie rod end ball studs up through steering knuckle arms and install nuts. Tighten right-hand nut securely and install cotter pin. Tighten the left-hand nut sufficiently to draw the ball stud into place, but do not tighten securely. Turn tie rod so that the offset is down. Tighten clamp bolt at right-hand tie rod end. Check and adjust front wheel toe-in (par. 141). When toe-in has been adjusted, tighten left tie rod end ball stud nut securely.

145. FRONT AXLE ASSEMBLY.

a. Cleaning Front Axle Housing Vent (fig. 163). Remove the vent assembly and wash in dry-cleaning solvent. Blow through vent with compressed air to make sure it is not plugged, and install vent assembly.

b. Removal of Differential and Carrier Assembly.

- (1) REMOVE WHEEL AND TIRE ASSEMBLIES (par. 163).
- (2) REMOVE DRIVE FLANGE FROM WHEEL HUB (par. 142 a (1)).
- (3) REMOVE HUB AND DRUM ASSEMBLIES (par. 142 a (3)).
- (4) REMOVE UNIVERSAL DRIVE ASSEMBLIES (par. 143 a (3)).
- (5) DISCONNECT STEERING TIE ROD AT ONE END (par. 144 c).
- (6) DISCONNECT PROPELLER SHAFT (par. 139).
- (7) REMOVE DIFFERENTIAL AND CARRIER ASSEMBLY. Remove drain plug and drain lubricant. Remove the attaching stud nuts and lower the assembly from the axle housing.

FRONT AXLE

c. Installation of Differential and Carrier Assembly.

- (1) **INSTALL DIFFERENTIAL AND CARRIER ASSEMBLY.** If the differential side bearing caps are attached with cap screws, place one new gasket over the housing studs. If the differential side bearing caps are attached with studs and nuts use three new gaskets. Install the carrier in the housing and securely tighten all attaching nuts.
- (2) **INSTALL UNIVERSAL DRIVE ASSEMBLIES** (par. 143 d (3)).
- (3) **INSTALL HUB AND DRUM ASSEMBLIES** (par. 142 c (2)).
- (4) **ADJUST FRONT WHEEL BEARINGS AND INSTALL DRIVE FLANGE** (par. 142 a).

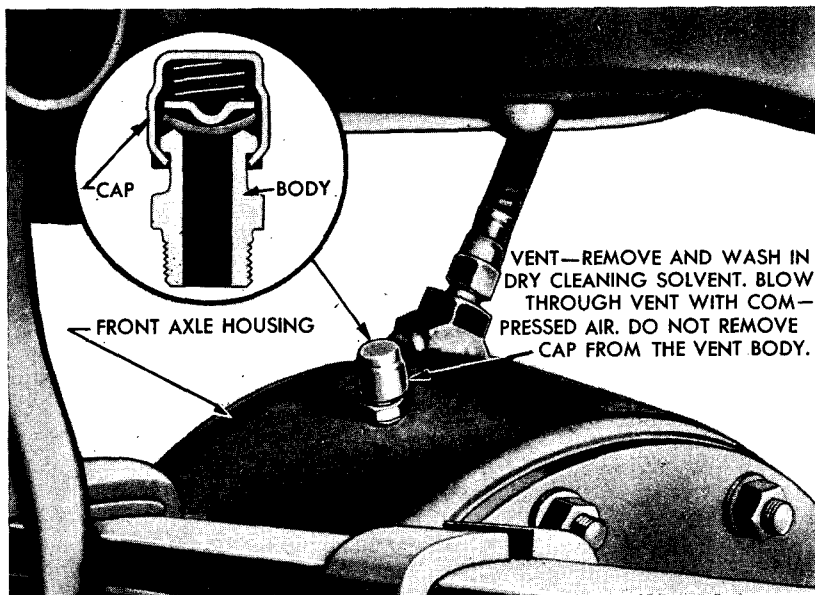

RA PD 52996

Figure 163—Front Axle Housing Vent

- (5) **INSTALL WHEEL AND TIRE ASSEMBLIES** (par. 163).
- (6) **CONNECT PROPELLER SHAFT** (par. 139).
- (7) **CONNECT STEERING TIE ROD** (par. 144 d).
- (8) **ADJUST BRAKES** (par. 151).

d. Removal of Front Axle Assembly.

- (1) **REMOVE WHEEL AND TIRE ASSEMBLIES** (par. 163).
- (2) **DISCONNECT PROPELLER SHAFT** (par. 139).
- (3) **DISCONNECT BRAKE TUBE.** Disconnect the brake tube from the front of the tee at the top of the axle housing.
- (4) **DISCONNECT FRONT END OF DRAG LINK** (par. 169).

3/4-TON 4 x 4 TRUCK (DODGE)

(5) **DISCONNECT SHOCK ABSORBER LINK EYEBOLTS.** Remove nut from lower end of shock absorber link eyebolts and raise eyebolts out of the spring clip plates.

(6) **REMOVE AXLE ASSEMBLY.** Remove nut from each end of four spring clips (U-bolts) and raise the clips out of spring clip plates. Then lower axle assembly and remove it from under vehicle.

e. Installation of Front Axle Assembly.

(1) **INSTALL AXLE AND CONNECT SHOCK ABSORBER LINKS.** Move axle assembly under vehicle and jack it into place. Install the spring clips and nuts with a standard lock washer above each nut. Connect the shock absorber link eyebolts to the spring clip plates.

(2) **CONNECT DRAG LINK TO STEERING ARM** (par. 169).

(3) **CONNECT BRAKE TUBE.** Connect the brake tube to the front of the tee on the top of the axle housing.

(4) **CONNECT PROPELLER SHAFT** (par. 139).

(5) **BLEED AIR FROM BRAKE SYSTEM** (par. 152).

(6) **INSTALL WHEEL AND TIRE ASSEMBLIES** (par. 163).

(7) **CHECK LUBRICANT LEVEL IN DIFFERENTIAL** (par. 24).

Section XXXII

REAR AXLE

	Paragraph
General description	146
Rear wheel bearings	147
Rear axle drive shafts	148
Rear axle assembly	149

146. GENERAL DESCRIPTION.

a. The rear axle is of the full-floating type with a hypoid ring gear and drive pinion. With this type axle it is possible to remove or replace the axle drive shaft without removing the wheels. The differential carrier assembly in the rear axle is identical with that used in the front axle.

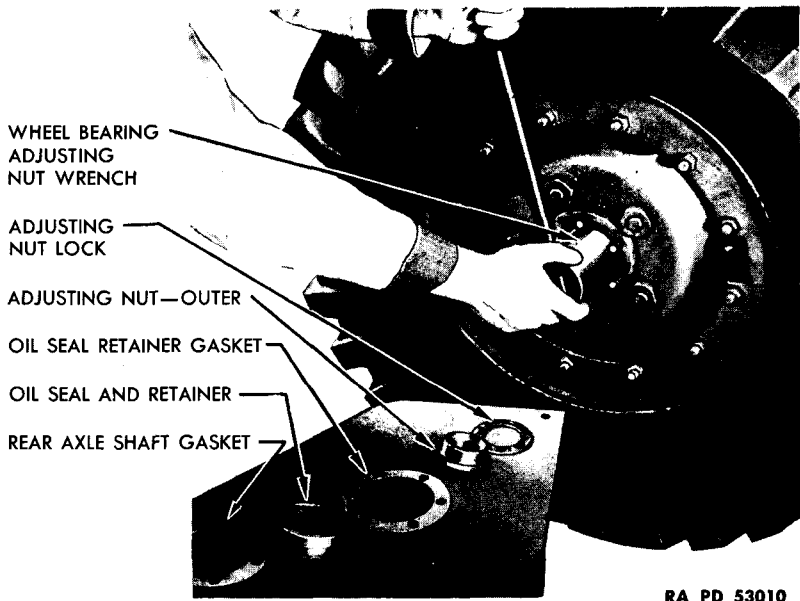

RA PD 53010

Figure 164—Adjusting Rear Wheel Bearing

147. REAR WHEEL BEARINGS.

a. **Adjustment of Rear Wheel Bearings.**

- (1) **JACK UP WHEEL.** Place a jack under the axle housing and raise the vehicle until the tire clears the ground.
- (2) **REMOVE AXLE DRIVE SHAFT** (par. 148).
- (3) **REMOVE WHEEL BEARING OUTER OIL SEAL** (subpar. b below).
- (4) **ADJUST BEARINGS** (fig. 164). Remove the wheel bearing outer adjusting nut, with wheel bearing adjusting nut wrench, and the

3/4-TON 4 x 4 TRUCK (DODGE)

adjusting nut lock. Turn the inner adjusting nut tight and then back it off about 1/6 of a turn. Install the adjusting nut lock, making sure that the dowel pin in the inner adjusting nut enters a hole in the lock. It may be necessary to turn the lock over or even turn the inner adjusting nut slightly to permit the dowel pin to enter one of the holes in the lock. With the lock over the dowel pin, install the outer adjusting nut and tighten it securely.

(5) **INSTALL WHEEL BEARING OUTER OIL SEAL** (subpar. c below).

(6) **INSTALL AXLE DRIVE SHAFT** (par. 148).

b. Removal of Outer Oil Seal (fig. 164). Remove axle drive shaft (par. 148). Slide the wheel bearing outer oil seal retainer off the axle shaft drive studs.

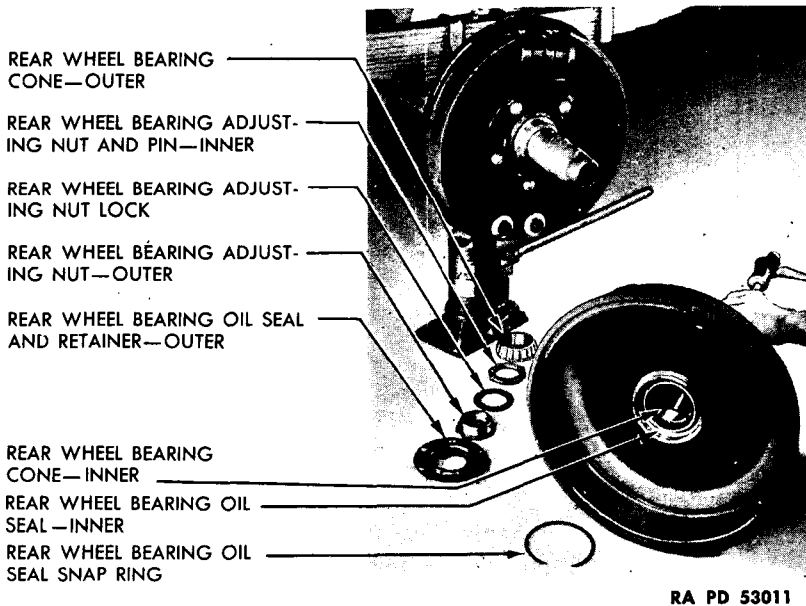

RA PD 53011

Figure 165—Removing Rear Wheel Bearing and Oil Seal

c. Installation of Outer Oil Seal (fig. 164). Soak the oil seal in light engine oil to make it pliable. Clean the outer end of the wheel hub and drive shaft studs. Install a good paper gasket over the drive studs. Inspect the wheel bearing outer adjusting nut. If the oil seal bearing surface is rough or grooved, replace the nut. Install the oil seal over the adjusting nut and the axle shaft drive studs. Install the axle drive shaft (par. 148).

d. Removal of Inner Oil Seal and Bearings (fig. 165). Before removing the wheel bearings or oil seals, put a new wheel bearing oil seal in thin oil and allow it to soak while the following operations are being performed.

REAR AXLE

- (1) JACK UP WHEEL. Raise vehicle with jack and place stand under axle housing.
- (2) REMOVE AXLE DRIVE SHAFT (par. 148).
- (3) REMOVE WHEEL AND TIRE ASSEMBLY (par. 163).
- (4) REMOVE WHEEL BEARING OUTER OIL SEAL (subpar. b above).
- (5) REMOVE BRAKE DRUM AND HUB (fig. 165). Turn the brake shoe adjusting cams to increase the clearance between the brake shoes and the drum. Remove the outer wheel bearing adjusting nut, adjusting nut lock, and inner adjusting nut with wheel bearing adjusting nut wrench. Remove the outer wheel bearing and pull the drum, hub, and inner wheel bearing, from the axle housing.
- (6) REMOVE OIL SEAL, CONE AND CUPS (fig. 165). Remove the rear wheel bearing oil seal snap ring from the inner end of the hub. Remove wheel inner bearing cone and oil seal from the hub by driving against the hub of the bearing cone with a large drift. Drift inner and outer bearing cups out of hub.

e. Installation of Inner Oil Seal and Bearings.

- (1) INSTALL WHEEL BEARINGS AND OIL SEAL (figs. 155 and 156). Install inner and outer bearing cups in hub, thick edge first. Pack the wheel inner bearing cone with wheel bearing grease and place the bearing cone in the bearing cup. Work the oil seal, after soaking in thin oil, by rolling with pressure applied by a smooth bar. Install the seal in the hub with oil seal drift (41-D-1535-50) and install the oil seal snap ring.
- (2) INSTALL HUB AND DRUM AND ADJUST BRAKE SHOES. Inspect the oil seal bearing surface and remove any roughness that may exist. Slide the hub and drum straight onto the axle housing. Exercise care to prevent damaging the oil seal. Pack the outer wheel bearing cone with wheel bearing grease and install the bearing and inner bearing adjusting nut on the housing. Adjust the wheel bearings (subpar. a (4) above). Turn brake shoe adjusting cams until brake drags and then back off just enough to free the drum.
- (3) INSTALL WHEEL BEARING OUTER OIL SEAL (subpar. c above).
- (4) INSTALL REAR AXLE DRIVE SHAFT (par. 148).
- (5) INSTALL WHEEL AND TIRE ASSEMBLY (par. 163).

148. REAR AXLE DRIVE SHAFTS.

a. Removal (fig. 152). Remove the six rear axle drive shaft flange retaining stud nuts. Remove the two flange puller screws from the axle shaft flange; remove the lock nuts from the screws and use the screws to pull the drive flange off the hub. Pull the drive shaft out of the housing. If the rear axle drive shaft is broken, and the break is less than four inches from the inner end of the shaft, it will be necessary to remove the differential carrier assembly; and the condition should be referred to ordnance personnel. If the break in the shaft is more than four inches from the inner end of the shaft, it will be

3/4-TON 4 x 4 TRUCK (DODGE)

necessary to snare the inner end of the shaft, pulling it through the housing with a wire loop.

b. Installation.

(1) **INSPECT DRIVE SHAFT CONTACTING SURFACES.** Make sure all contacting surfaces are clean and free of foreign matter which would prevent the shaft flange, the oil seal retainer and the wheel hub seating properly against the gasket when tightened down with the retaining nuts.

(2) **INSTALL PULLER SCREWS AND LOCK NUTS.** Remove the puller screws from the drive shaft flange and install the lock nuts. Reinstall the screws in the flange so that the ends of the screws do not protrude through the flange, and tighten the lock nuts.

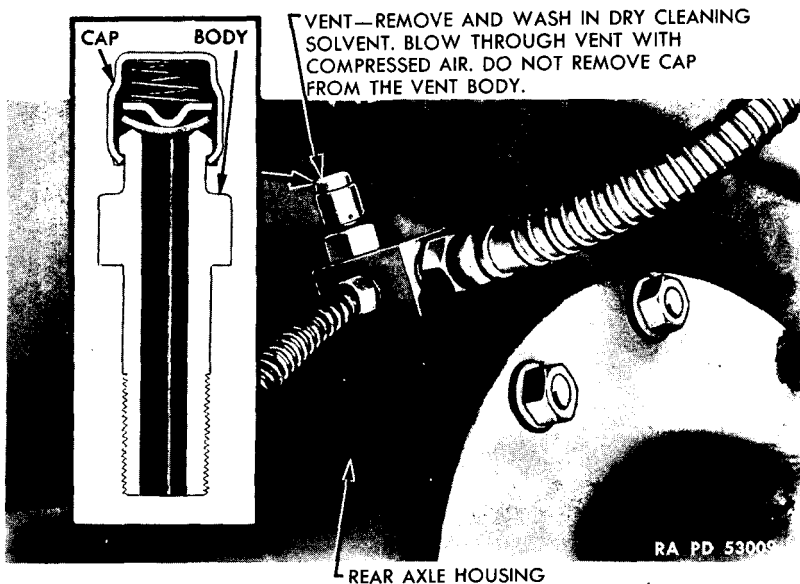

Figure 166—Rear Axle Housing Vent

(3) **INSTALL DRIVE SHAFT.** Place a new gasket on the drive studs and install the drive shaft in the housing. Engage the splines on the inner end of the shaft with the differential side gear and push the shaft into place. Install standard lock washers and flange attaching nuts on the drive studs and tighten evenly.

149. REAR AXLE ASSEMBLY.

a. Cleaning Rear Axle Housing Vent. Remove the vent assembly and wash in dry-cleaning solvent. Blow through vent with compressed air to make sure it is not plugged and install vent assembly (fig. 166).

REAR AXLE

b. Removal of Differential and Carrier Assembly.

- (1) REMOVE AXLE DRIVE SHAFTS (par. 148 a).
- (2) DISCONNECT PROPELLER SHAFT (par. 139).
- (3) REMOVE DIFFERENTIAL AND CARRIER ASSEMBLY. Remove drain plug and drain lubricant. Remove the attaching stud nuts and lower the assembly from the axle housing.

c. Installation of Differential and Carrier Assembly.

- (1) INSTALL DIFFERENTIAL AND CARRIER ASSEMBLY. If the differential side bearing caps are attached with cap screws, place one new gasket over the housing studs. If the differential side bearing caps are attached with studs and nuts, use three new gaskets. Install the carrier in the housing and securely tighten all attaching nuts.
- (2) INSTALL AXLE DRIVE SHAFTS (par. 148 b).
- (3) CONNECT PROPELLER SHAFT (par. 139).

d. Removal of Rear Axle Assembly.

- (1) DISCONNECT BRAKE TUBE. Disconnect the brake tube from the brake hose at the brake tube to hose bracket located on the frame cross member. Disconnect the hose from the brake tube to hose bracket by removing the attaching nut.
- (2) DISCONNECT PROPELLER SHAFT AT DRIVE PINION FLANGE (par. 139).
- (3) REMOVE WHEEL AND TIRE ASSEMBLY (par. 163).
- (4) REMOVE REAR AXLE ASSEMBLY. Remove the spring clip nuts. Remove the spring clips and clip plates. Lower the axle from the vehicle with the jack.

e. Installation of Rear Axle Assembly.

- (1) INSTALL REAR AXLE ASSEMBLY. Place the rear axle on the jack and roll it into position under the vehicle. Jack up the axle until it contacts the rear springs. Make certain that the center bolts line up properly in the holes provided in the pads that are a part of the rear axle housing. Install the spring clips down through the plates. Install standard lock washers and nuts and tighten the nuts securely.
- (2) INSTALL WHEEL AND TIRE ASSEMBLIES (par. 163).
- (3) CONNECT PROPELLER SHAFT (par. 139).
- (4) CONNECT BRAKE HOSE. Connect the brake hose to the hose bracket located on the frame cross member and tighten the attaching nut. Attach the frame brake tube to the brake hose and tighten the connection.
- (5) BLEED BRAKE SYSTEM (par. 152).

3/4-TON 4 x 4 TRUCK (DODGE)

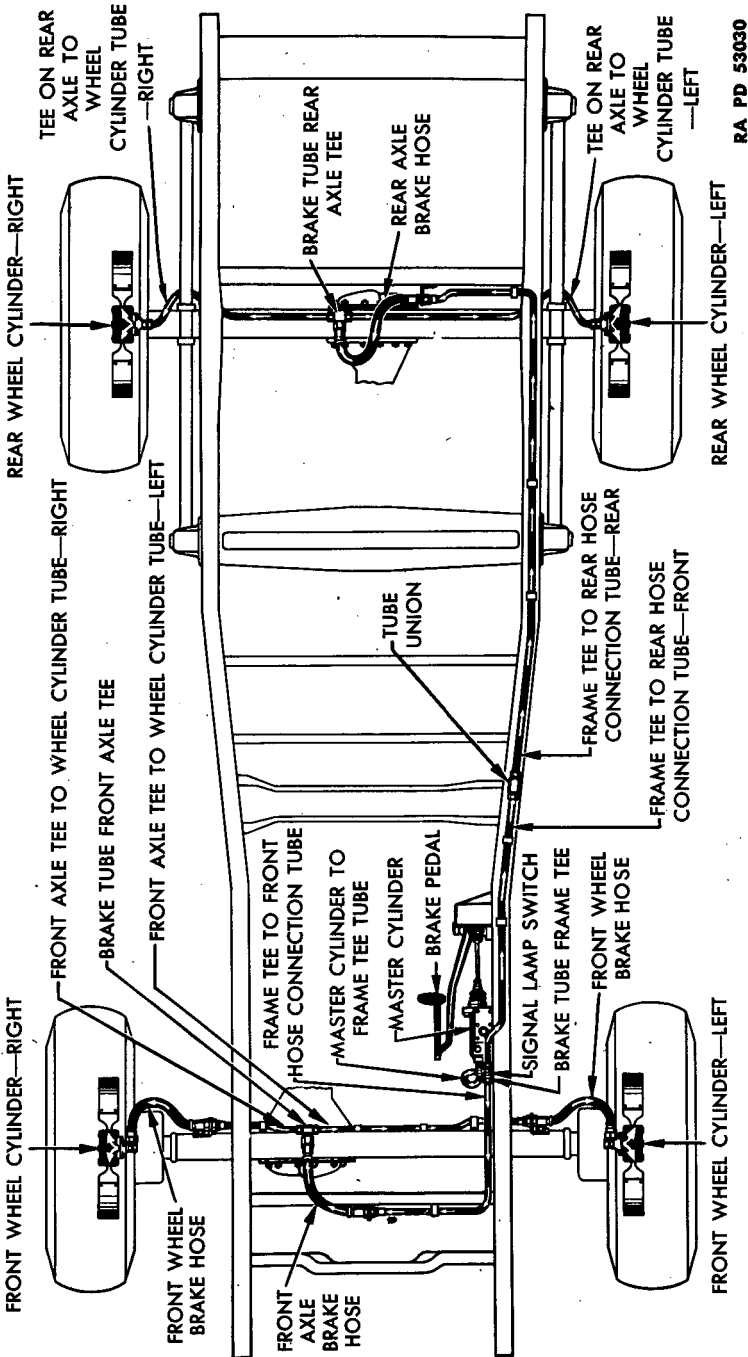

Figure 167—Brake System

Section XXXIII

FOOT BRAKES

	Paragraph
General description	150
Brake adjustments	151
Bleeding brake system	152
Brake shoes, linings, and drums	153
Wheel cylinders	154
Master cylinder	155

150. GENERAL DESCRIPTION.

a. The foot brakes (fig. 167) are of the hydraulic expanding type and operate on all four wheels. The brake pedal is connected to a piston which operates within a master cylinder. When the brake pedal is depressed, the master cylinder piston forces fluid under equal pressure to all four wheel cylinders. The fluid enters the wheel cylinders between two pistons, causing the pistons to move in opposite directions and push the brake shoes against the brake drums. Adjustments are provided to compensate for wear of the brake shoe linings. However, because the hydraulic pressure is always equal to all four wheels, no adjustment is provided or required to equalize the brake shoe pressure.

151. BRAKE ADJUSTMENTS.

a. **Minor Brake Adjustment.** A minor brake adjustment consists of adjusting the brake shoe cams which control only the released position of the brake shoes. The minor adjustment will reduce brake pedal travel caused by brake lining or drum wear, or will relieve brake drag caused by lack of clearance between the brake shoes and drum. Before attempting to adjust the brakes, make certain the master cylinder piston rod is properly adjusted (subpar. c (3) below) and that wheel bearings have no play. *Do not adjust brake shoes when brake drums are hot, because the drums will contract when they cool off and cause the brakes to drag.*

(1) **ADJUST BRAKE SHOE CAMS** (fig. 168). Jack up wheel until the tire is clear of the ground. Revolve the wheel and turn one brake shoe cam pin until the brake shoe contacts the drum and causes the brake to drag. Then turn the cam pin in the opposite direction just enough to eliminate the brake drag. Adjust the other shoe in the same manner and repeat the operation on the other three wheels.

(2) **CHECK FLUID LEVEL IN MASTER CYLINDER** (fig. 169). Remove the filler plug from top of the master cylinder. If fluid level is more than $\frac{3}{4}$ inch below top of opening, add fluid to proper level and install filler plug.

b. **Major Brake Adjustment.** A major brake adjustment consists of adjusting the brake shoe anchor bolts so that the full area of the shoe lining will contact the brake drum when the brakes are applied.

3/4-TON 4 x 4 TRUCK (DODGE)

A major brake adjustment may be required when the brake shoe and lining assemblies are replaced or when the brake drums are resurfaced or replaced. Before attempting to make a major adjustment, make certain the master cylinder piston rod is properly adjusted (subpar. c (3) below) and that the wheel bearings have no play. **CAUTION:** *While making a brake adjustment, do not apply the brakes as the resulting distortion of the various parts will make it impossible to accomplish an accurate adjustment.*

(1) **REMOVE WHEEL AND TIRE ASSEMBLY** (par. 163). Install two of the wheel stud nuts and tighten with wheel wrench so that brake drums will be held in proper alinement.

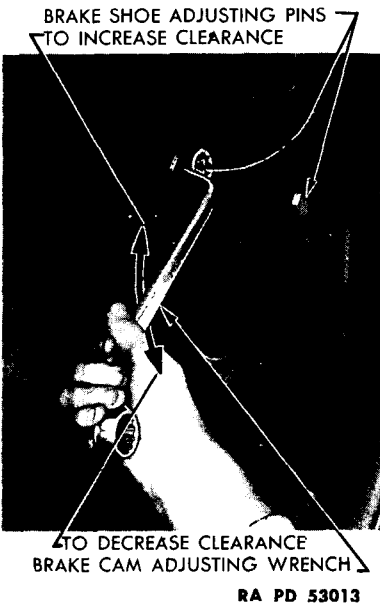
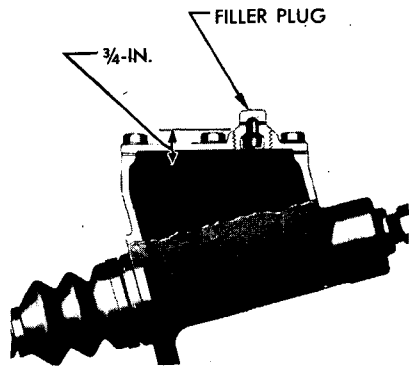

Figure 168—Adjusting Brake Shoe Cam



REMOVE THE FILLER PLUG. IF THE FLUID LEVEL IS MORE THAN 3/4-IN. BELOW TOP OF OPENING, ADD BRAKE FLUID UP TO THE 3/4-IN. LEVEL AND INSTALL FILLER PLUG

RA PD 53012

Figure 169—Master Cylinder Fluid Level

(2) **POSITION ANCHOR BOLTS** (fig. 170). Loosen anchor bolt lock nuts. Turn anchor bolts to the fully released position so that the dots on any pair of anchor bolts face toward each other and the flats of the anchor bolts are in the same horizontal plane. This can best be determined by placing a straightedge across the flats of the anchor bolts.

(3) **ADJUST BRAKE SHOE CAMS** (fig. 170). Turn the brake shoe adjusting cams so that a 0.006-inch feeler gage will be a snug fit between the toe of the brake shoe lining and drum.

(4) **ADJUST ANCHOR BOLTS** (fig. 170). Turn the anchor bolts in the direction indicated by the arrows in figure 170, to decrease the

FOOT BRAKES

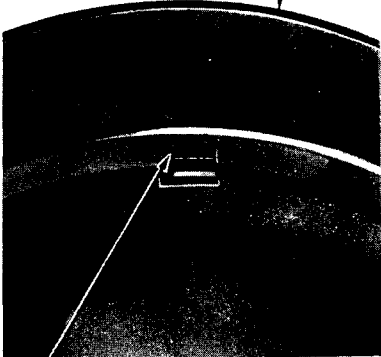
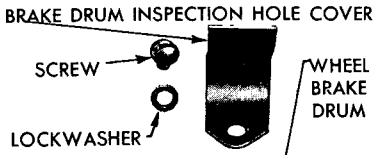

INSPECTION OPENING WITH THE COVER REMOVED
DRUM INSPECTION HOLE

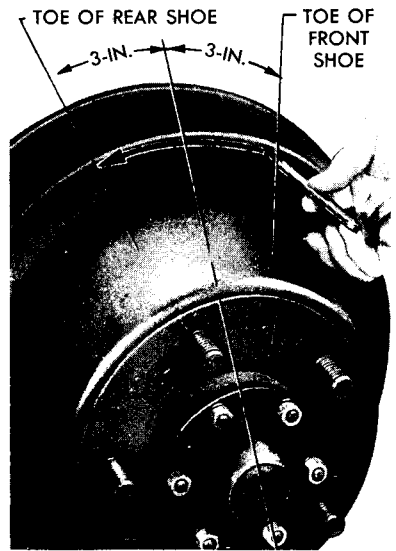

TOE CLEARANCE 0.012-IN.
TOE ADJUSTMENT

HEEL CLEARANCE 0.006-IN.

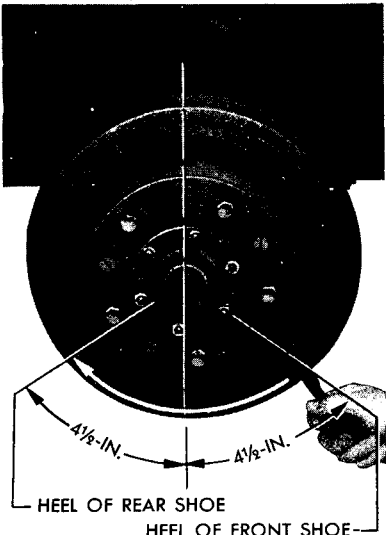

HEEL ADJUSTMENT

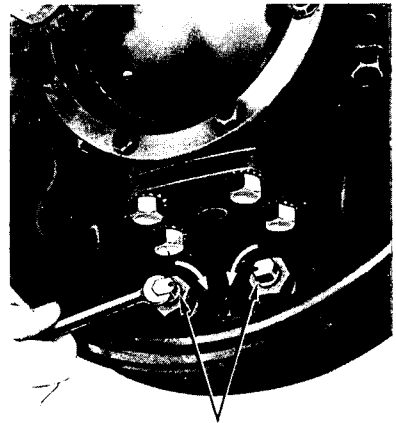

TURN THE BRAKE SHOE ANCHOR BOLTS IN THE DIRECTION OF ARROWS TO DECREASE CLEARANCE BETWEEN THE HEEL OF THE SHOE AND THE BRAKE DRUM—TURN IN THE OPPOSITE DIRECTION TO INCREASE CLEARANCE.

ANCHOR BOLT ADJUSTMENT

RA PD 58366

Figure 170—Brake Shoe Adjustments

3/4-TON 4 x 4 TRUCK (DODGE)

clearance between the heel of the brake shoe lining and drum to 0.006 inch. This will cause the brake shoe to move down and out, increasing the clearance at the toe of the brake shoe lining to approximately 0.012 inch, resulting in proper centralization of the brake shoes. When the shoes have been adjusted, hold the anchor bolt from turning and tighten the lock nuts securely. If the pedal travel is too great after the adjustments have been completed, decrease the clearance between the toe of the shoe lining and the drum. Make certain the brakes do not drag.

(5) **INSTALL COVER OVER INSPECTION HOLE.** Place the cover over the inspection hole in the drum and install the attaching screw with a standard lock washer under the head of the screw.

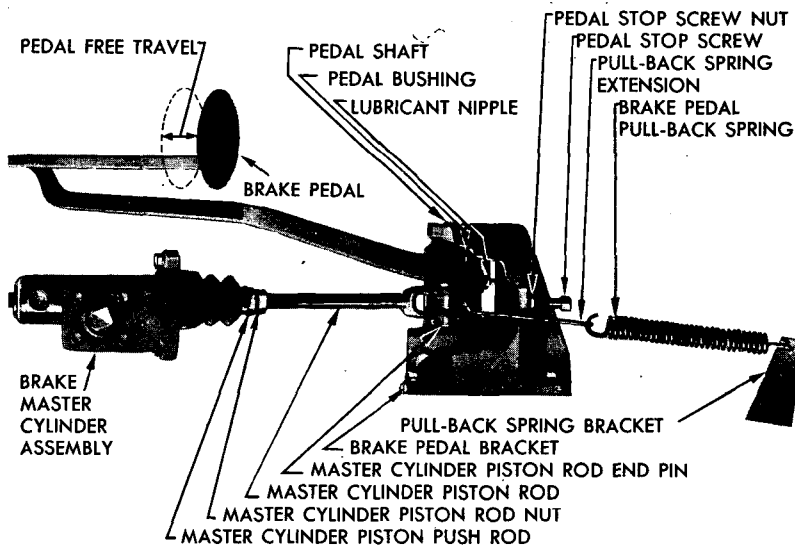

RA PD 53018

Figure 171—Brake Pedal Adjustments

(6) **INSTALL WHEEL AND TIRE ASSEMBLY** (par. 163).

(7) **CHECK THE FLUID LEVEL IN THE MASTER CYLINDER** (fig. 169). Remove the filler plug from the top of the master cylinder. If the fluid level is more than 3/4-inch below the top of the opening, add brake fluid to proper level and install filler plug.

c. Adjustment of Brake Pedal Free Travel.

(1) **DESCRIPTION** (fig. 171). The backward travel of the brake pedal is limited by a stop screw so that the pedal will not strike the engine rear support when released. The pedal free travel is the amount of movement of the pedal from its fully released position to the point where noticeable resistance is felt in the downward movement of the

FOOT BRAKES

pedal. This free travel is controlled by the length of the master cylinder piston rod.

(2) **CHECK PEDAL STOP SCREW ADJUSTMENT** (fig. 171). Depress and release the brake pedal and note whether it contacts the engine rear support. If so, loosen the lock nut on the pedal stop screw and turn the stop screw in the bracket so that the pedal does not contact the engine support when the pedal is released.

(3) **ADJUST MASTER CYLINDER PISTON ROD** (fig. 171). Loosen the lock nut at the front end of the rod between the pedal and the master cylinder and turn the master cylinder piston rod until the pedal has $\frac{7}{16}$ -inch free travel.

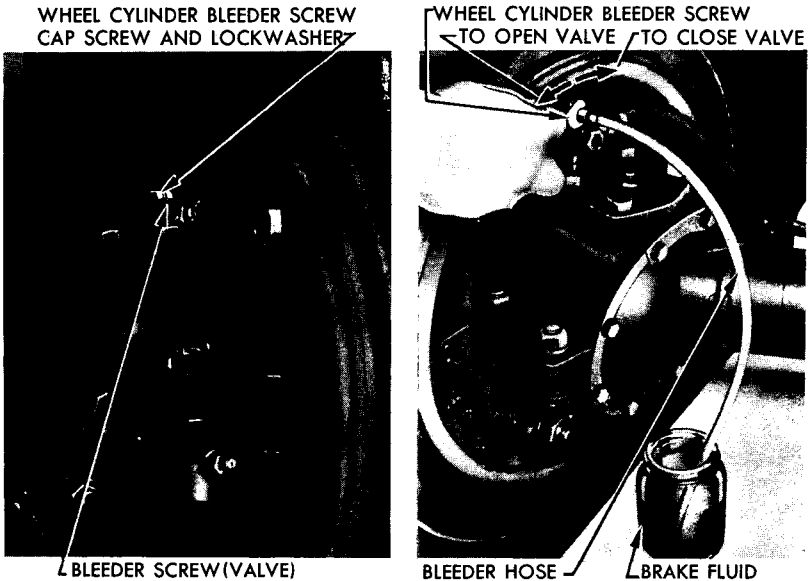

RA PD 65956

Figure 172—Bleeding Brake At Wheel Cylinder

152. BLEEDING BRAKE SYSTEM.

a. Bleeding Brake System with Hydraulic Brake Filler.

(1) **ATTACH HYDRAULIC BRAKE FILLER.** Partially fill the brake filler with hydraulic brake fluid. Attach air hose to connection at top of the filler and apply 25 pounds air pressure to the filler tank. Remove the plug from the top of the master cylinder. Place end of filler hose in master cylinder, open the shut-off valve in the filler hose slightly and fill the master cylinder to top of the opening. Install tapped fitting in master cylinder filler opening. Install threaded nipple into the tapped fitting and connect the filler hose to the nipple. Before tight-

3/4-TON 4 x 4 TRUCK (DODGE)

ening the hose to nipple connection, open the shut-off valve slightly and when fluid, free of air, is forced out of the loose connection, tighten the connection and open the shut-off valve fully.

(2) **BLEED BRAKE SYSTEM** (fig. 172). Remove the cap screw from the wheel cylinder bleeder screw and attach the bleeder tube. Submerge the free end of the bleeder tube in brake fluid in a receptacle. Open the bleeder screw and allow fluid to flow into the receptacle until fluid coming from the brake system is clear and free of air bubbles. Then close the bleeder screw securely, remove the bleeder tube and install cap screw. Follow this procedure at all four wheel cylinders.

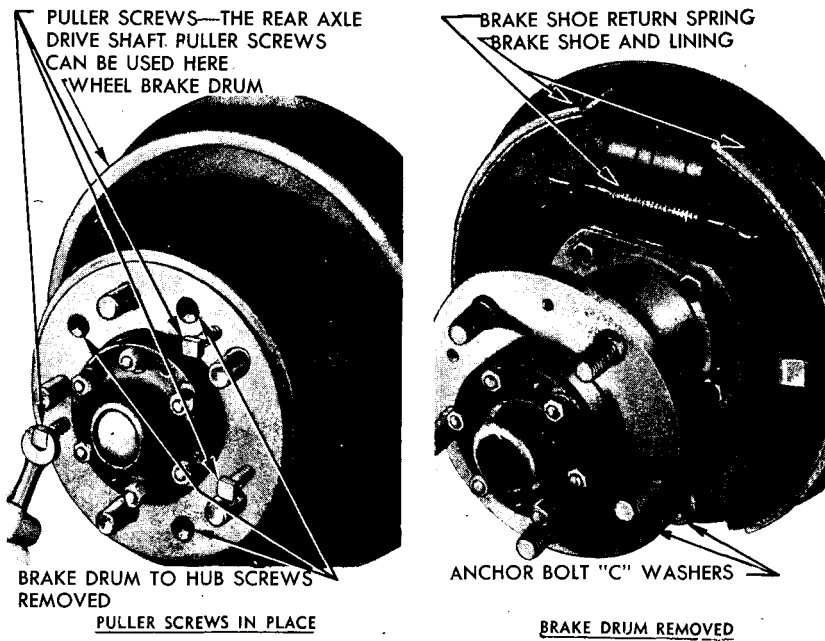

RA PD 65955

Figure 173—Removing Brake Drum

(3) **LOWER FLUID LEVEL IN MASTER CYLINDER.** When the last of the four wheel cylinders has been completely bled and while the bleeder screw is still open and the bleeder tube is still in the receptacle of fluid, close the shut-off valve in the filler hose and disconnect the hose from the master cylinder. Push the brake pedal all the way down and hold it down while the bleeder screw at the wheel cylinder is being closed. Then release the brake pedal. This will lower the fluid in the master cylinder to approximately 3/4 inch below the top of the filler opening. Remove fittings and install filler plug in master cylinder.

FOOT BRAKES

b. Bleeding Brake System without Use of Hydraulic Filler Tank.

(1) **FILL MASTER CYLINDER.** Remove the filler plug from the top of the master cylinder and fill the cylinder with clean fresh brake fluid.

(2) **BLEED EACH OF THE FOUR WHEEL CYLINDERS** (fig. 172). Remove the cap screw from the wheel cylinder bleeder screw and attach the bleeder tube. Submerge the free end of the bleeder tube in brake fluid in a receptacle and open the bleeder screw. Push the brake pedal down slowly about half way, then allow the pedal to return to its released position. Keep refilling the master cylinder and repeat the brake pedal operation until clear fluid, free of air bubbles, flows from the bleeder tube when the pedal is pushed down. Close the bleeder screw securely; remove the bleeder tube and install the cap screw.

(3) **CHECK FLUID LEVEL IN MASTER CYLINDER.** Measure the fluid level in the master cylinder and add fluid if necessary to bring fluid to $\frac{3}{4}$ inch from top of the filler opening. Install filler plug.

153. BRAKE SHOES, LININGS, AND DRUMS.

a. Cleaning and Inspection of Brakes.

(1) **REMOVE WHEEL AND TIRE ASSEMBLY** (par. 163).

(2) **REMOVE BRAKE DRUM** (fig. 173). Turn brake shoe cams to increase clearance between shoes and drum (fig. 168). Remove three countersunk screws which hold brake drum to hub. Remove puller screws from rear axle drive shaft flange, remove lock nuts and use the screws in holes provided in drum to pull the drum from the hub.

(3) **CLEAN AND INSPECT BRAKES.** Brush dust or dirt from the brake shoes and interior of the brake drum. Inspect brake return spring and brake anchor "C" washers for being intact. Inspect brake shoe lining. If linings are worn down to rivets, loose on shoe, or greasy, replace shoe and lining assemblies (subpars. b and c below). Inspect brake drum. If badly scored or cracked, notify ordnance personnel.

(4) **INSTALL BRAKE DRUM.** Remove puller screws from drum and install the screws and lock nuts in the rear axle drive shaft flange. Lubricate hub with water pump lubricant to facilitate future removal of the drum. Place drum over the hub so that the attaching screw holes line up with the tapped holes in the hub. Install the attaching screws and draw the drum into place. Make sure the drum is tight against the flange of the hub by tapping with a hammer, and tighten the screws securely.

(5) **CHECK BRAKE ANCHOR BOLT ADJUSTMENT** (par. 151).

(6) **CHECK FLUID LEVEL IN MASTER CYLINDER** (fig. 169). Measure fluid level in master cylinder and add fluid if necessary to bring fluid to $\frac{3}{4}$ inch from top of filler opening.

(7) **INSTALL WHEEL AND TIRE ASSEMBLY** (fig. 163).

¾-TON 4 x 4 TRUCK (DODGE)

b. Removal of Brake Shoes.

- (1) REMOVE WHEEL AND TIRE ASSEMBLY (par. 163).
- (2) REMOVE BRAKE DRUM (subpar. a (2) above).
- (3) REMOVE BRAKE SHOES (figs. 174 and 175). Place clamp over brake cylinder to hold pistons in brake cylinder and remove brake shoe return spring. Remove shoe anchor bolt nuts and washers and tap out anchor bolts. Swing brake shoes out of brake cylinder and remove from brake support.

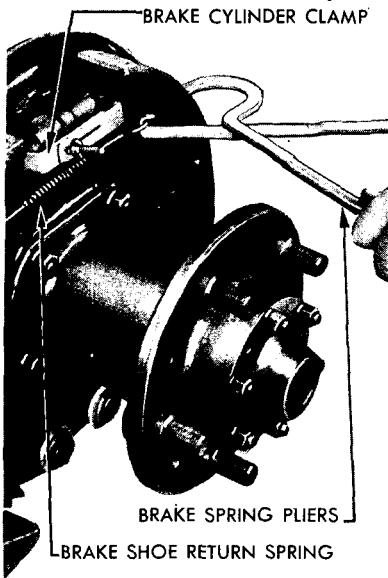

RA PD 53026

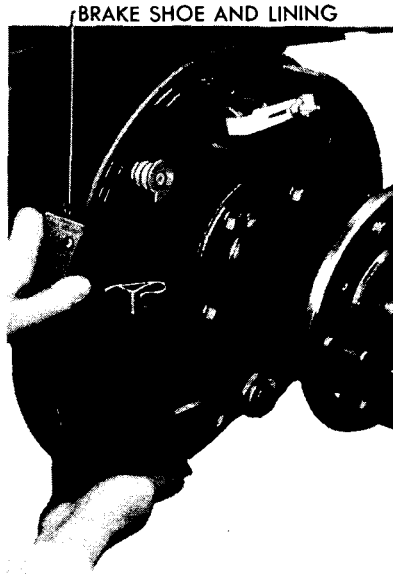

RA PD 312567

Figure 174—Removing Brake Shoe Return Spring

Figure 175—Removing Brake Shoe and Lining

- (4) INSPECT BRAKE DRUM. If the brake drum is excessively scored or cracked, notify higher authority.

c. Installation of Brake Shoes.

- (1) INSTALL BRAKE SHOES. Place the brake shoes in position on the support assembly, forcing them into the guide springs on each side. Lubricate anchor bolts with a thin coating of chassis grease and install them complete with oil washers, retainers, and "C" washers. Install the anchor bolt lock washers and nuts. Attach the brake shoe return spring and remove the brake cylinder clamp.

- (2) INSTALL BRAKE DRUM (subpar. a (4) above). Turn the anchor bolts so that the prick punch marks on the inner end of the

FOOT BRAKES

bolts are toward each other (fig. 170). The drum can then be installed. Make major brake adjustment (par. 151).

- (3) INSTALL WHEEL AND TIRE ASSEMBLY (par. 163).

154. WHEEL CYLINDERS.

a. Removal.

- (1) REMOVE WHEEL AND TIRE ASSEMBLY FROM HUB (par. 163).
- (2) REMOVE BRAKE DRUM FROM HUB (par. 153).
- (3) REMOVE CYLINDER (fig. 178). Disconnect brake hose from brake cylinder. Remove two cap screws which hold brake cylinder to brake support. Remove brake shoe return spring. Swing brake shoes out of brake cylinder.

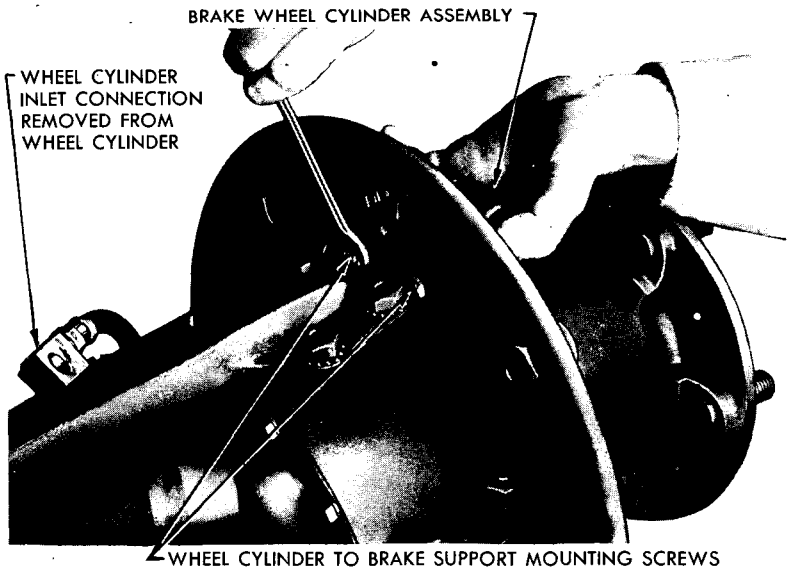

RA PD 53028

Figure 176—Removing Wheel Cylinder

b. Installation.

- (1) INSTALL BRAKE CYLINDER (fig. 176). Place brake cylinder on brake support and install two cap screws. Then connect brake hose with washers on both sides of inlet connection. Swing brake shoes into position and attach brake shoe return spring.
- (2) INSTALL BRAKE DRUM ON HUB (par. 153).
- (3) BLEED AIR FROM BRAKE SYSTEM (par. 152).
- (4) INSTALL WHEEL AND TIRE ASSEMBLY (par. 163).

3/4-TON 4 x 4 TRUCK (DODGE)**155. MASTER CYLINDER.****a. Removal (fig. 177).**

(1) REMOVE LEFT ENGINE DUSTPAN. Disconnect the chassis wiring cable from the engine dustpan and remove the clip, bolt and nut. Remove the front spring torque arrester assembly. Remove the cap screws that hold the dustpan to the frame side member and the front cap screw that holds the dustpan to rear of front frame cross member.

(2) REMOVE MASTER CYLINDER. Disconnect hydraulic brake tube from the master cylinder. Remove the three cap screws which hold the master cylinder to the mounting bracket. Pull the cylinder forward and disconnect the push rod from the brake pedal.

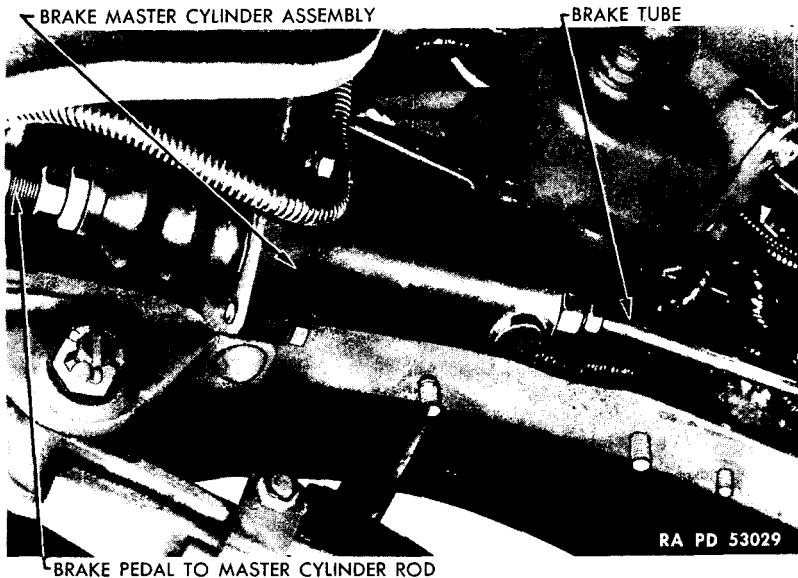

Figure 177—Master Cylinder

b. Installation (fig. 177).

(1) INSTALL MASTER CYLINDER. Insert the push rod through the brake cylinder mounting bracket and install the clevis pin and cotter pin in the brake pedal. Install the three cap screws which hold the cylinder to the bracket with a toothed lock washer under the head of each cap screw. Connect the brake tube to the master cylinder.

(2) INSTALL LEFT ENGINE DUSTPAN. Place the dustpan in position and insert battery box drain hose in hole provided for it on vehicle with 6-volt electrical systems. Install the toothed lock washers on the two dustpan cap screws and tighten the screws. Tighten the frame tee bracket bolt. Place torque arrester in position on the frame

FOOT BRAKES

side member and attach it with the bolts, toothed lock washers and nuts. Attach the chassis wiring cable with the wiring clip to the dustpan. Install the screw that attaches the dustpan to the frame front cross member. Insert the screw by reaching down between the radiator and engine. Place the wiring and fuel line clip and lock washer on the screw and tighten.

(3) BLEED THE BRAKE SYSTEM (par. 152).

3/4-TON 4 x 4 TRUCK (DODGE)

Section XXXIV

HAND BRAKE

	Paragraph
General description	156
Hand brake adjustment	157
Band and lining	158
Hand brake lever and linkage	159
Hand brake drum	160

156. GENERAL DESCRIPTION.

a. The hand brake consists of a drum mounted at the rear of the transmission with a contracting band. The hand brake operates independently of the foot brakes and applies equal braking force to the wheels through the differentials.

157. HAND BRAKE ADJUSTMENT.

a. Procedure.

(1) **ADJUST HAND BRAKE ROD.** Set hand brake lever in the fully released position. Remove the cotter pin and clevis pin from the rear end of the hand brake rod. Loosen the lock nut and adjust the rod so that with the hand lever in the fully released position, the cam levers bear squarely against the brake band. Install the clevis and cotter pin and tighten the lock nuts with $\frac{5}{8}$ inch open-end wrench (41-W-3579).

(2) **ADJUST ANCHOR CLIP SCREW** (fig. 178). Remove the anchor clip screw lock wire. Adjust the anchor clip screw so there is 0.010 inch to 0.012 inch clearance between the drum and the lining at the anchor. Install a lock wire through the anchor clip and screw.

(3) **ADJUST BRACKET ADJUSTING SCREW** (fig. 178). Back off the adjusting bolt lock nuts until free with $\frac{5}{8}$ -inch box wrench (41-W-635). Adjust the bracket adjusting screw so there is 0.010 inch to 0.012 inch clearance between the drum and the bottom of the band and lock the nuts together.

(4) **ADJUST ADJUSTING BOLT NUTS** (fig. 178). Turn adjusting bolt nuts down until the bracket adjusting screw is just relieved of tension with $\frac{5}{8}$ inch box wrench (41-W-635). If a new band and lining assembly does not form a true circle, it may be necessary to alter the adjustment slightly to establish clearance all the way around the drum. In that case readjust the band after the lining has worn to a true circle.

(5) **LOCK ADJUSTING BOLT NUTS** (fig. 178). Place a $\frac{5}{8}$ inch open-end wrench (41-W-3579) between the hand brake and transfer case levers and on the lower nut to hold it from turning. With a short $\frac{5}{8}$ inch box wrench (41-W-635) reach between the frame cross member and the floor plate and tighten the lock nut.

HAND BRAKE

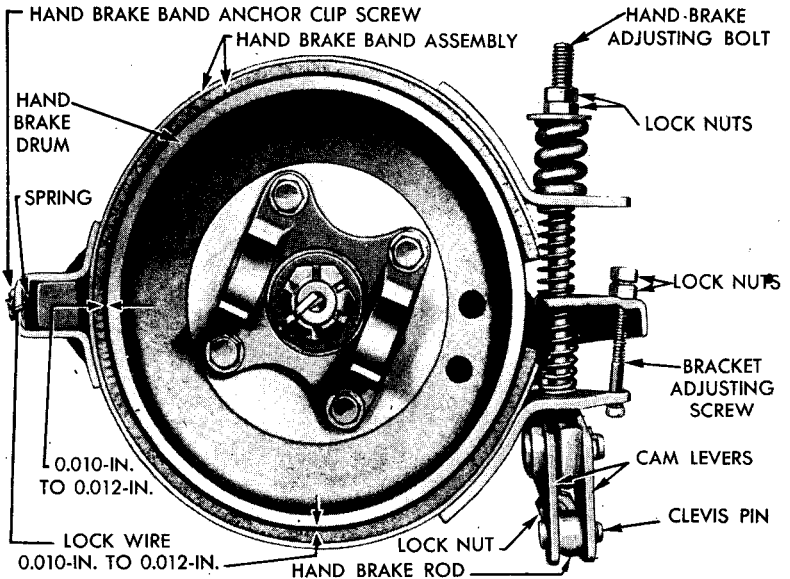

RA PD 53031

Figure 178—Hand Brake Adjustments

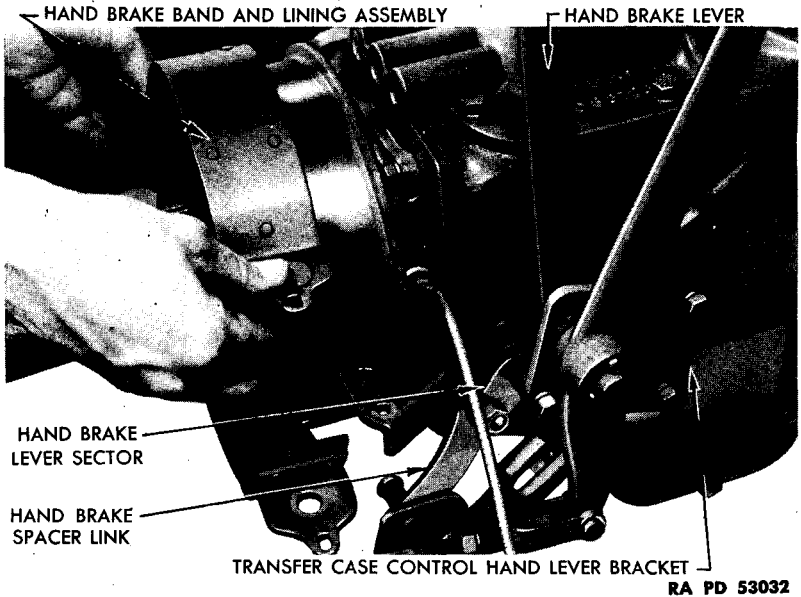

RA PD 53032

Figure 179—Removing Hand Brake Band

3/4-TON 4 x 4 TRUCK (DODGE)

158. BAND AND LINING.

a. Removal.

(1) **LOOSEN FRAME CROSS MEMBER (EXCEPT AMBULANCE)** (par. 133 a (7)).

(2) **REMOVE BAND AND LINING ASSEMBLY** (fig. 179). Remove cotter pin and yoke pin from the hand brake rod and remove cotter pin from spacer link. Remove lock nuts, plain washer, and operating spring, from top of the adjusting bolt. Pull the adjustment bolt down out of the band and remove the two adjusting bolt springs. Remove the bracket adjusting screw. Remove the band anchor clip screw lock wire and screw. Remove the small coiled spring from between the anchor and the anchor bracket and slide the band and lining assembly off the brake drum.

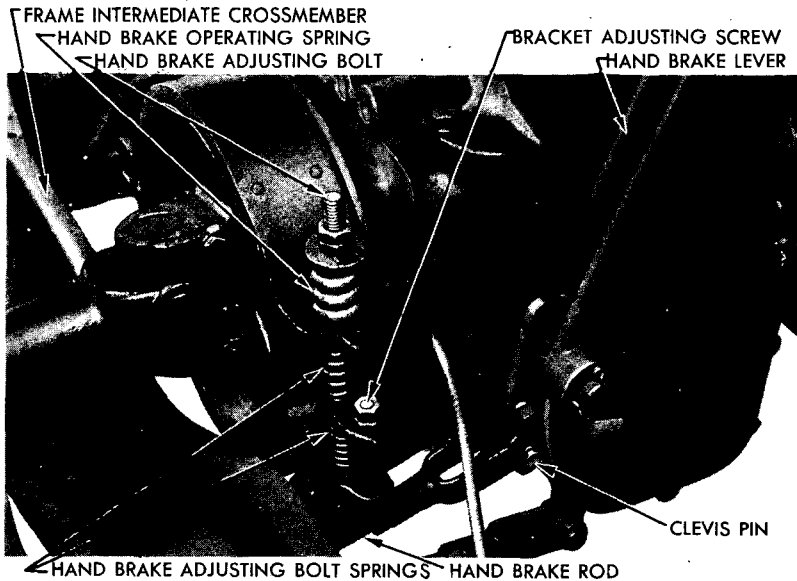

RA PD 53033

Figure 180—Hand Brake Linkage

b. Installation.

(1) **INSTALL BAND AND LINING ASSEMBLY** (fig. 179). Slide the hand brake band over drum and anchor. Install small coiled spring between the anchor and outer edge of anchor bracket. Install anchor clip screw through anchor bracket and small coiled spring. Install bracket adjusting screw, nut and lock nut. Install adjusting bolt up through the band and bracket, with coiled springs above and below the bracket. Install operating spring, plain washer, and adjusting bolt lock nuts on upper end of the adjusting bolt. Place spacer link over

HAND BRAKE

link stud and install cotter pin. Install yoke pin and cotter pin in end of hand brake rod.

- (2) ADJUST BRAKE BAND (par. 157).
- (3) INSTALL FRAME CROSS MEMBER (par. 133 b (3)).

159. HAND BRAKE LEVER AND LINKAGE.

a. **Removal of Lever** (fig. 180). Remove the cotter pin and clevis pin from the front end of the hand brake rod. Remove the three cap screws which hold the brake sector and the transfer case lever bracket to the transmission case. Remove the nut which holds the brake sector to the brake band spacer link. Lift the lower end of the lever over the front axle propeller shaft and pull the lever down through the floor pan.

b. **Installation of Lever** (fig. 180).

(1) **INSTALL LEVER AND LEVER BRACKET.** Raise lever up between the exhaust pipe and the front axle propeller shaft and through the slot in the floor plate. Place the lever sector over the stud in the spacer link and install toothed lock washer and nut.

(2) **ASSEMBLE LEVER BRACKET TO TRANSMISSION CASE.** Insert three cap screws which hold the brake lever sector and the transfer case lever bracket to the transmission through the transfer case lever bracket. Place the short spacer tubes over each of the two lower cap screws. Insert the two cap screws through the bracket and sector and start them into the transmission case. Place the longer spacer tube over the upper cap screw and tighten the three cap screws.

(3) **CONNECT HAND BRAKE ROD.** Install clevis pin through hand brake rod clevis and brake lever. Install cotter pin through clevis pin.

c. **Removal of Hand Brake Rod.** Remove cotter pins from clevis pins at each end of the hand brake rod and remove the rod.

d. **Installation and Adjustment of Hand Brake Rod.**

(1) **INSTALL ROD.** Install clevis pin through the hand brake rod yoke and the hand lever and install cotter pin.

(2) **ADJUST PULL ROD.** Loosen lock nut on the hand brake rod and adjust the rod so that when the hand lever is in the fully released position, the brake cam levers squarely contact the brake band. Install clevis pin through the brake cam levers and the eye at the rear end of the hand brake rod and install cotter pin through the clevis pin.

160. HAND BRAKE DRUM.

a. **Removal.**

(1) **LOOSEN FRAME CROSS MEMBER (EXCEPT AMBULANCE)** (par. 133 a (7)).

(2) **REMOVE BAND AND LINING ASSEMBLY** (par. 158 a (2)).

(3) **DISCONNECT PROPELLER SHAFT** (par. 139).

(4) **REMOVE BRAKE DRUM.** Remove cotter pin from nut which holds universal joint companion flange to transmission main shaft.

3/4-TON 4 x 4 TRUCK (DODGE)

Remove the nut. Drive the brake drum off transmission main shaft.

(5) **REMOVE UNIVERSAL JOINT COMPANION FLANGE.** Remove four bolts and nuts which hold flange and drum together. Tap drum from the flange.

b. Installation.

(1) **CONNECT UNIVERSAL JOINT COMPANION FLANGE.** Place companion flange through brake drum and install four bolts and nuts with a toothed lock washer under each nut.

(2) **INSTALL BRAKE DRUM.** Place brake drum over splines on transmission main shaft. Install attaching nut. Install cotter pin through nut and shaft.

(3) **CONNECT PROPELLER SHAFT** (par. 139).

(4) **INSTALL AND ADJUST BRAKE BAND** (pars. 158 **b** (1) and 157).

(5) **INSTALL FRAME CROSS MEMBER** (par. 133 **b** (3)).

Section XXXV

WHEELS AND TIRES

	Paragraph
General description	161
Tire inflation and care	162
Wheel and tire assembly	163
Spare wheel and tire assembly	164
Tire casing and tube	165

161. GENERAL DESCRIPTION.

a. Wheel and tire assemblies are interchangeable, front and rear. The tires are retained on the wheels by a side ring which is attached to the wheel by studs and nuts. A bead lock ring (fig. 181) is assembled between the beads of the tire to prevent the tire from coming off the wheel when deflated.

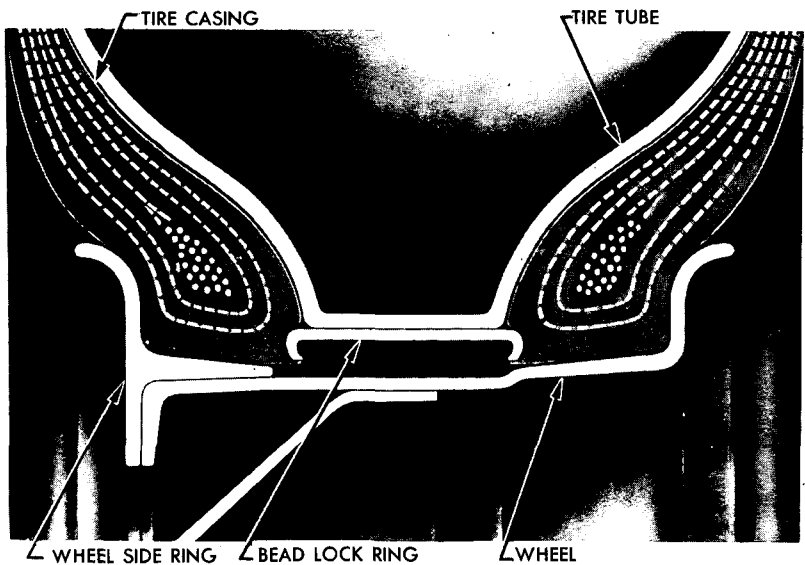

RA PD 53036

Figure 181—Cross-Section of Tire Mounted on Wheel

162. TIRE INFLATION AND CARE.

a. **Tire Inflation.** The life of the tire depends largely upon load and inflation. Inflate all tires to 40 pounds pressure. This is particularly important so as to maintain the same rolling radius of all four tires when in four-wheel drive.

(1) **KEEP TIRES INFLATED.** An under-inflated tire causes the cords to pull loose from the position in which they were originally vulcan-

3/4-TON 4 x 4 TRUCK (DODGE)

ized, as well as irregular tread wear. When a tire is over-inflated, only the center of the tread comes in contact with the road. Wear is then more rapid because it is concentrated on a small section of the tread. The wheels will also bounce and spin causing the rubber to scuff off. Tire cords are easily broken when an over-inflated tire runs over a sharp cornered chuckhole or other obstacle.

(2) **INSTALL VALVE CAPS.** After tire pressures are checked, see that all valve caps are securely in place. The tire valve is actually a check valve and although its sealing efficiency is high, the valve cap is the sealing unit. The valve cap contains an inside rubber washer and plate to insure positive sealing. Be sure to keep valve caps in place at all times.

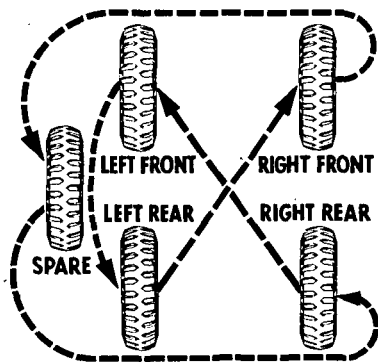

CHANGE THE SPARE TO THE
RIGHT REAR.
CHANGE THE RIGHT REAR TO
LEFT FRONT.
CHANGE THE LEFT FRONT TO
LEFT REAR.
CHANGE THE LEFT REAR TO
RIGHT FRONT.
CHANGE THE RIGHT FRONT
TO THE SPARE.

TIRE ROTATION WITH SPARE

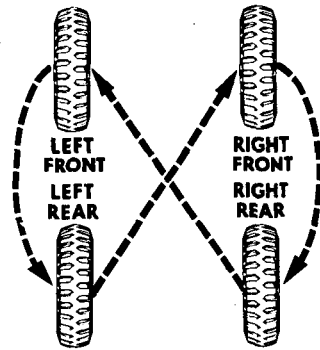

CHANGE THE RIGHT FRONT TO
RIGHT REAR.
CHANGE THE RIGHT REAR TO
LEFT FRONT.
CHANGE THE LEFT FRONT TO
LEFT REAR.
CHANGE THE LEFT REAR TO
RIGHT FRONT.

TIRE ROTATION WITH NO SPARE

RA PD 58367

Figure 182—Tire Rotation

b. Care of Tires. Change the position of the tire and wheel assemblies as shown in figure 182. Changing the direction of rotation increases tire life. Repair any damage to tires as soon as possible after damage is discovered. Prompt repairs of small damage will save tires that might otherwise be ruined in a short distance. Do not allow oil or grease to contact tires unnecessarily.

163. WHEEL AND TIRE ASSEMBLY.

a. Removal. Jack up wheel and remove the five large nuts which hold the wheel to the hub. Turn the nuts on the left wheel clockwise and the nuts on the right wheel counterclockwise to remove.

WHEELS AND TIRES

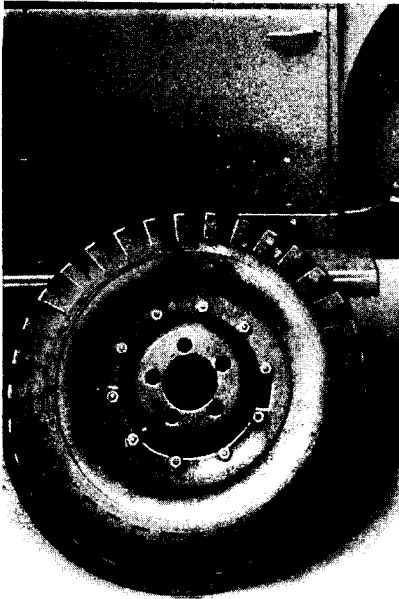

FIRST POSITION



SECOND POSITION

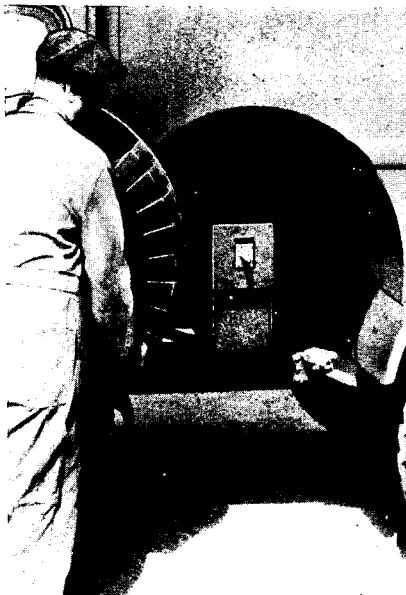

THIRD POSITION

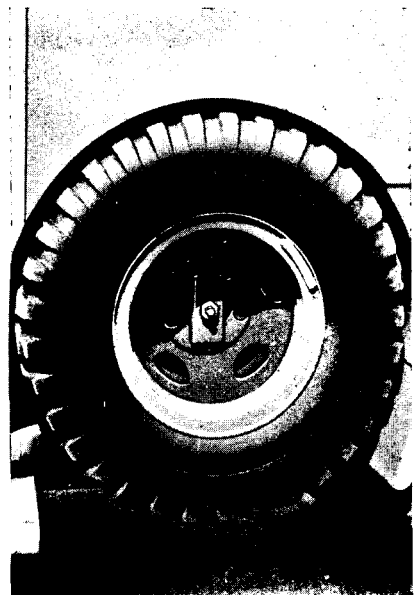

FINAL POSITION

RA PD 58369

Figure 183—Installing Spare Wheel on Carrier

3/4-TON 4 x 4 TRUCK (DODGE)

b. **Installation.** Install wheel and tire assembly on mounting studs. Turn nuts clockwise to install on right wheel and counter-clockwise to install on left wheel. Tighten nuts, then remove jack and tighten each nut securely.

164. SPARE WHEEL AND TIRE ASSEMBLY.

a. **Removal.** Insert key in lock, turn key clockwise and pull lock off the mounting stud. Remove the large retaining nut, plain washer, and plate which hold the wheel to the carrier bracket. **CAUTION:** *Lower wheel and tire assembly carefully to avoid possible personal injury.*

b. **Installation** (fig. 183). Roll the wheel and tire assembly against the running board with the outside of the wheel out. To make mounting the wheel to the carrier bracket easier and avoid possible personal injury, lift the bottom of the tire out, and up until the tire rests on the running board with the inside of the wheel out. Then lift the wheel and tire assembly to the carrier bracket. On the Ambulance, hook the center opening in the wheel disk over the clip on the carrier bracket. Place the retaining plate and plain washer over the carrier bracket stud. Install the large stud nut and push the lock into place.

165. TIRE CASING AND TUBE.

a. **Removal** (fig. 184).

(1) **REMOVE TIRE FROM WHEEL.** Deflate inner tube if not already deflated. Remove the 10 nuts which hold the side ring to the wheel. Pry the side ring away from the tire and off the studs. Drive the tire away from the inner flange and off the wheel.

(2) **REMOVE TUBE FROM CASING.** Pry open the bead lock ring hinge, thus reducing the diameter of the ring. Turn the bead lock ring at right angles to the tire and slide it off the valve stem. Remove the tube from the casing.

b. **Inspection.** Inspect the inner and outer surfaces of the casing for cuts, breaks, or any foreign material that would damage the tube. If possible, repair any damage to casing before installing the tire. Inspect the tube and valve for leaks by inflating the tube and holding a portion of the tube at a time under water. A leak will be indicated by air bubbles rising to the surface of the water.

c. **Installation.**

(1) **COAT TIRE BEADS WITH SOAPY WATER.** Installation of the bead lock ring in the casing and assembly of tire on the wheel is made easier by coating the base of the tire beads with soapy water. Do not use oil or grease.

(2) **INSTALL TUBE AND BEAD LOCK RING IN CASING** (fig. 185).

(a) Install the inner tube in the tire with valve stem opposite balance dot on tire to maintain balance of the tire and wheel assembly. Inflate the tube sufficiently to just round it out to prevent the tube falling out of the tire or being pinched during the mounting oper-

WHEELS AND TIRES

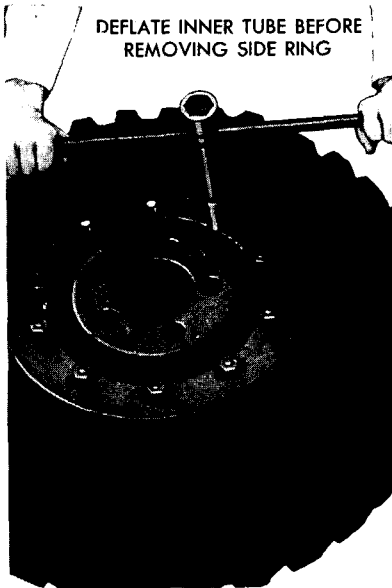

WHEEL SIDE RING BOLT NUTS

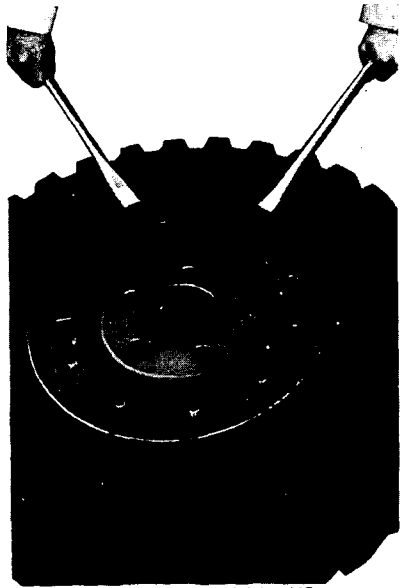

PRYING WHEEL SIDE RING



DRIVING WHEEL FROM TIRE

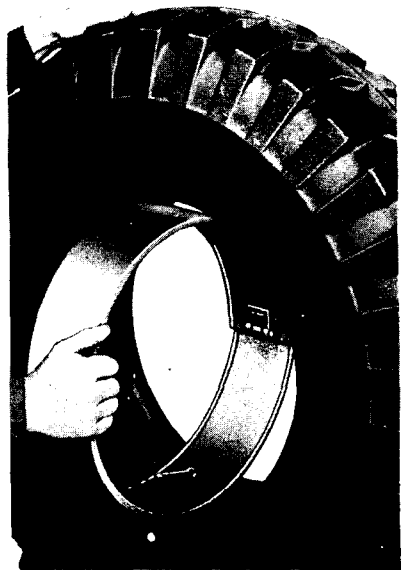

SLIDING TIRE BEAD LOCK RING OFF
VALVE STEM RA PD 301080

Figure 184—Removing Tire from Wheel

3/4-TON 4 x 4 TRUCK (DODGE)

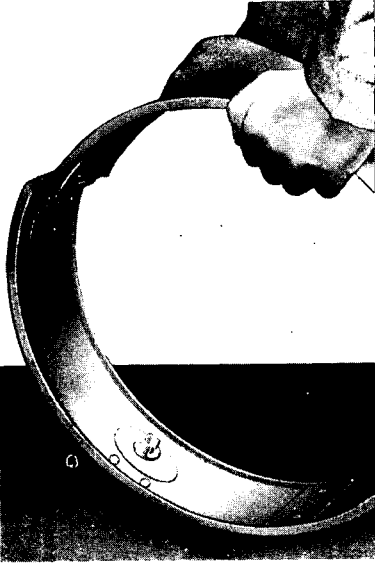

COLLAPSING TIRE BEAD
LOCK RING

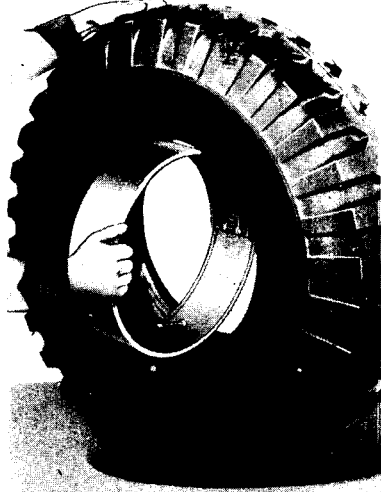

SLIDING TIRE BEAD LOCK
RING ON VALVE STEM



EXPANDING TIRE BEAD
LOCK RING IN TIRE



TIRE BEAD LOCK RING
INSTALLED

RA PD 65948

Figure 185—Installing Tire Bead Lock Ring

WHEELS AND TIRES

ation. This will also facilitate installation of the bead lock ring. With a quick pressure on the bead lock ring about eight inches from the hinge, collapse it to the limit which the hinge will allow.

(b) Hold the tire with the tube installed, upright with valve stem at point nearest the ground, and insert the valve stem through the driving lug of the bead lock ring with ring at right angle to the tire. Pull the stem up through the bead lock ring so that the valve stem rests on top of the lug. Then apply pressure to the bead lock ring until the point opposite the valve opening is centered between the beads of the tire.

(c) Apply air pressure to the tube to spread the beads of tire apart for a distance approximately equal to the width of the bead lock ring. Then swing the ring, using the valve opening as an axis, until it slips into place between the beads of the tire. With the bead lock ring in this position, release enough air from the tube to permit the ends of the bead lock ring to be returned to their normal position. To do this, hold the extended end of the lock ring in place with one foot and give the depressed end a quick upward pull with both hands.

(d) Inspect the complete assembly to make sure that the bead lock ring is properly centered with its edges below the base of the tire bead.

(3) **INSTALL TIRE ON WHEEL.** Place the wheel on blocks high enough to prevent the tire sidewalls touching the ground when the tire is in place on the wheel. Drop the tire down over the wheel, carefully centering the valve stem in the slot in the wheel. Be sure neither the tire nor the valve stem is cocked as this would cause difficulty in mounting the tire. Install the tire side ring so that the valve stem is centered in one of the valve slots in the side ring. Tap the side ring down and start the side ring nuts on the studs. Proper installation of the tire side ring nuts will avoid distortion of the side ring. Begin by drawing down at least three side ring nuts on each side of ring. Do not draw down the nuts at the cut-outs first, as this would cause distortion of the side ring at these points. Draw down all nuts evenly and alternately until they are all tight and inflate the tire to 40 pounds pressure.

3/4-TON 4 x 4 TRUCK (DODGE)

Section XXXVI

STEERING

	Paragraph
General description	166
Steering gear	167
Steering gear (Pitman) arm	168
Drag link	169

166. GENERAL DESCRIPTION.

a. The steering gear is the worm and sector type. Adjustments for proper mesh and elimination of end play can be made without removing the assembly from the vehicle.

167. STEERING GEAR.

a. Adjustment of Steering Gear in Vehicle.

(1) PRELIMINARY CHECKS.

(a) *Check for Backlash.* Turn the steering wheel all the way to right or left, then 1/4 turn in the opposite direction. With the wheel in that position there will be backlash in the steering gear. If the steering wheel can be moved back and forth through the backlash without noticeable resistance, the steering post is in alignment.

(b) *Check for Bend in Steering Post.* If the steering wheel does not move freely through the backlash, there is excessive friction in the steering post, caused by misalignment of the post, excessive end thrust on the steering gear, worn bearings or a tight steering column jacket bushing. Remove the bracket which holds the steering post to the instrument panel. If the post shifts when the bracket is removed and the excessive friction is relieved or if the post bears up against the instrument panel, realine the post (step (2) below).

(c) *Check Worm Adjustment.* If the excessive friction is not relieved by removing the clamp from the instrument panel and the post does not bear against the panel, loosen the four cap screws which hold the steering gear housing cap to the steering gear housing (fig. 186). If the friction is then relieved, adjust the steering gear worm bearings (step (3) below). If friction still exists, with the post bracket clamp removed, post not bearing against the instrument panel and the steering gear housing cap loose, the steering column jacket bushing is binding. Notify higher authority. Install post bracket clamp and tighten the steering gear housing cap screws.

(2) STEERING POST ALIGNMENT.

(a) *Adjust Bracket.* If the steering post moves down or bears against the instrument panel when the bracket is removed, loosen the bolts which hold the steering gear housing to the frame. Move the steering post into position and install bracket. Tighten the steering housing to the frame. If the steering post moves sidewise when

STEERING

the bracket is removed, shift the clamp on the instrument panel to meet the post by elongating the bolt holes in the clamp and the instrument panel.

(b) *Install Bracket.* Install the steering post bracket. Place a toothed lock washer on each of the two attaching bolts. Insert the right bolt through the clamp and instrument panel, install another toothed lock washer over the bolt, and install the nut. Install the left bolt through the ground strap, place another toothed lock washer over the bolt, then insert the bolt through the clamp and instrument panel. Install a third toothed lock washer over the bolt and install the nut.

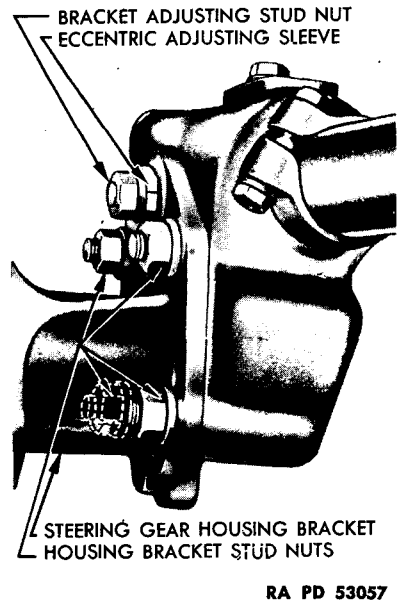
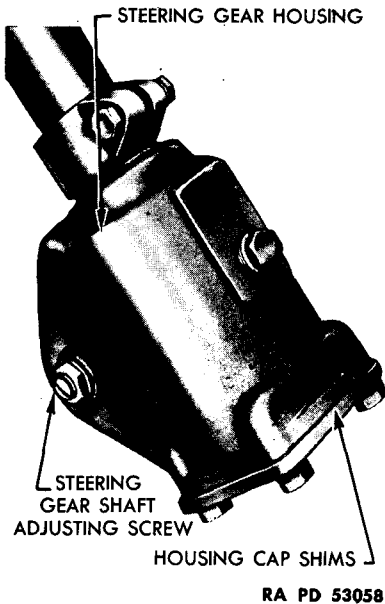

**Figure 186—Worm and Shaft
End Play Adjustments**

**Figure 187—Worm and Sector
Mesh Adjustment**

(3) **WORM BEARING ADJUSTMENT** (fig. 186).

(a) *Check Adjustment.* Turn the steering wheel all the way to right or left, then $\frac{1}{4}$ turn in the opposite direction. With the wheel in that position, side thrust on the worm bearings will be relieved and there will be some backlash in the steering gear. Separate the connector in the horn wire between the steering gear and the horn. Remove the four cap screws which hold the cap to the lower end of the steering gear housing and remove the cap. Shims of three different thicknesses (0.010 in., 0.005 in., and 0.003 in.) are used at this point.

3/4-TON 4 x 4 TRUCK (DODGE)

(b) *Remove or Install Shims as Required.* When the cap is tightened into place there should be slight resistance to the backlash in the wheel and no end play in the worm. Use a knife to separate top shims, passing the blade all the way around between the shims, taking care not to mutilate the remaining shims. Check end play by lifting up and pushing down on the steering wheel while holding a finger against the joint between the bottom of the steering wheel hub and the steering column jacket. Any end play in the worm can be felt at that point. When adjustment is completed, connect the horn wire and make sure the insulator is over the connector.

(4) **STEERING GEAR SHAFT ADJUSTMENT** (fig. 186). Loosen lock nut on steering gear shaft adjusting screw. Loosen the screw so that

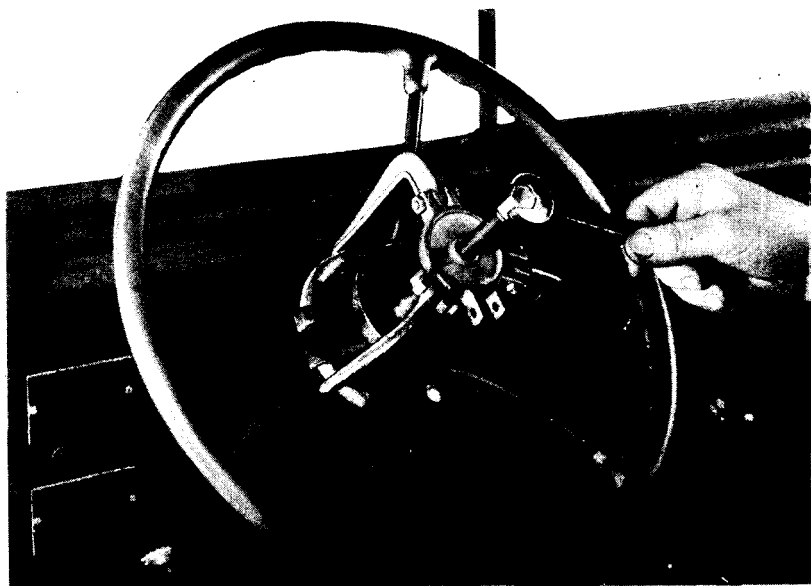

RA PD 312568

Figure 188—Removing Steering Wheel

end play can be felt in the shaft by pushing in and pulling out on the steering gear arm. Turn the adjusting screw in just enough to eliminate the end play and tighten the lock nut.

(5) **WORM AND SECTOR ADJUSTMENT** (fig. 189).

(a) *Locate Steering Gear Mid-Position.* Remove rear end of drag link from steering gear arm (par. 169). With drag link disconnected, turn the steering wheel to the extreme right or left. Then turn it all the way in the opposite direction, counting the number of turns required to make the turn from one extreme to the other. Then turn the steering wheel back $\frac{1}{2}$ that number of turns. At this position, the spoke with the trade mark (composition type wheels)

STEERING

should point directly down. On later model vehicles having a steel spoke wheel, the spoke adjacent to the two square openings in the lower edge of the wheel hub should point straight down. If the spoke does not point straight down, rotate the steering wheel the nearest way to bring the spoke straight down. The steering gear will then be in mid-position.

(b) *Adjust Worm and Sector.* Loosen the housing bracket to frame bolts. Loosen the four housing bracket stud nuts $\frac{1}{4}$ turn and the bracket adjusting stud nut $\frac{1}{2}$ turn. Turn the eccentric adjusting sleeve clockwise very slowly, checking at each movement the amount



RA PD 53065

Figure 189—Removing Steering Gear Arm

of lost motion still existing at the steering gear arm. Adjust to a point where a slight resistance is felt in mid-position as the wheel is moved back and forth. With this adjustment correctly made, tighten the housing bracket stud nuts and the bracket adjusting stud nut. Turn the steering wheel throughout full travel and test for free operation. Backlash will be noticeable when the wheel is turned from the mid-position. Tighten the housing bracket to frame bolts. Install drag link to the steering gear arm (par. 169).

b. Removal of Steering Wheel (fig. 188). Remove horn button and cable assembly (par. 120 d). Remove nut which holds the steering wheel on the tube. Pull steering wheel off the tube.

3/4-TON 4 x 4 TRUCK (DODGE)

c. **Installation of Steering Wheel.** Install the steering wheel key in the steering gear tube and install the steering wheel on the tube. Install the horn button lower retainer plate, steering wheel nut, and tighten the nut. Place the horn button retainer plate spring on the lower retainer plate and install horn button and cable assembly (par. 120 e).

168. STEERING GEAR (PITMAN) ARM.

a. **Removal (fig. 189).** Disconnect drag link at steering gear arm (par. 169). Remove the steering gear arm nut. Install the steering gear arm puller and pull the arm from the steering gear shaft.



Figure 190—Adjusting Drag Link End



Figure 191—Removing Drag Link from Steering Arm

b. **Installation.** Turn the front wheels by hand so they are set in the straight ahead position. Locate the mid-position of the steering gear (par. 167 a (5) (a)). Connect drag link to steering gear arm (par. 169). Install the steering gear arm on the steering gear shaft and drive the arm on the shaft. Install the steering gear arm lock washer and nut and tighten securely.

169. DRAG LINK.

a. **Adjustment (fig. 190).** Remove lubricating fitting. Remove lock wire. Screw end plug in tight, then back it off to the nearest lock wire hole. Install lock wire and lubricating fitting.

STEERING

b. Removal and Disassembly (fig. 191). Remove lubricating fitting. Remove lock wire. Unscrew and remove the end plug. Remove the metal dust cover. Turn the steering wheel back and forth to loosen the ball socket and allow the drag link to be lifted off the ball of the steering arm.

c. Inspection. Inspect the ball on the steering arm and the steering gear arm. If either ball is damaged or worn excessively out of round, replace the arm.

d. Assembly and Installation. Place drag link end over ball on the steering arm and install the metal dust cover. Install the ball socket, spring, and end bumper in order. Install end plug and screw the plug in tight, then back it off to the nearest lock wire hole. Install wire lock and lubricating fitting. Lubricate through lubricating fitting.

3/4-TON 4 x 4 TRUCK (DODGE)

Section XXXVII

FRAME

	Paragraph
General description	170
Bumpers	171

170. GENERAL DESCRIPTION.

a. The frame (fig. 192) is constructed of pressed steel channel section side rails reinforced by cross members. A pintle hook is mounted on the rear cross member of the frame and a tow hook is attached to each of the frame front horns.

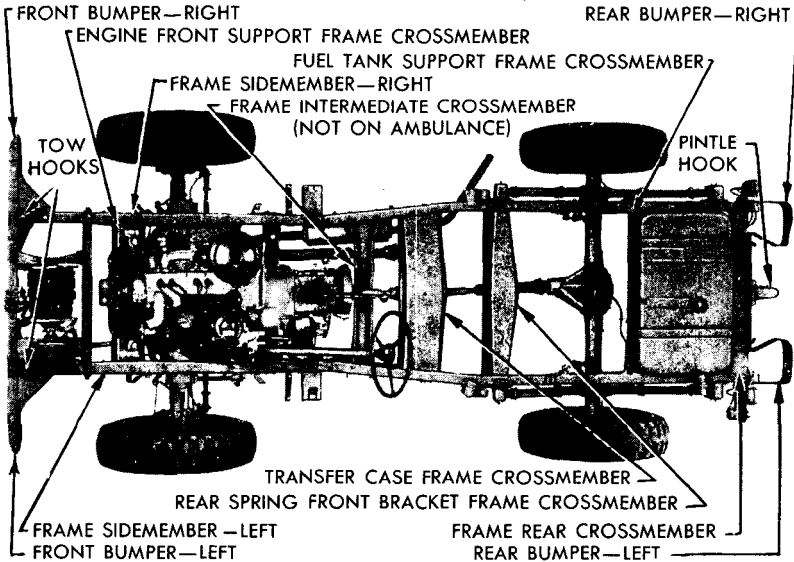

RA PD 53068

Figure 192—Frame

171. BUMPERS.

a. **Removal of Front Bumper (Vehicles without Winch).** Remove the two tow hook to frame bolts and nuts. Loosen the two tow hook to frame rear bolts and nuts and swing the tow hook to one side. Remove the two upper bumper to frame bolts and nuts and the four upper bumper to bumper reinforcement bracket bolts and nuts. Remove the four lower bumper to bumper support bracket bolts and nuts.

FRAME

b. Installation of Front Bumper (Vehicles without Winch). Install the two upper bumper to frame bolts and nuts with lock washers. Install the four upper bumper to reinforcement bracket bolts and nuts with lock washers. Install the two tow hook to frame front bolts and nuts with lock washers. Tighten the two tow hook to frame rear bolts and nuts.

c. Removal of Front Bumper (Vehicles with Winch). Remove the two upper front bumper to frame bolts and nuts. Remove the two upper winch cable guide to bumper bolts. Remove the four upper bumper to reinforcement bracket bolts and nuts and the eight lower support bracket to bumper bolts and nuts. Pull right and left bumpers from frame.

d. Installation of Front Bumper (Vehicles with Winch). Insert upper flange of right and left bumpers between winch cable guide and frame. Install the two bolts and nuts with lock washers through the winch cable guide, the bumper and frame. Install the two winch cable guide to bumper bolts. Install the four upper bumper to reinforcement bracket bolts and nuts with lock washers and the eight lower support bracket bolts and nuts with lock washers.

e. Removal of Rear Bumper (Except Carryall). Remove the four bolts and nuts which attach the tail and signal lamp brackets to the frame. Remove the two remaining bolts and nuts which attach the bumper to the rear of the frame side member. Remove the four bumper to cross member bolts and nuts. Disconnect the ground strap (if so equipped) at the bumper.

f. Installation of Rear Bumper (Except Carryall).

(1) **INSTALL BUMPER.** Install the plain washers on the two upper bolts or eyebolts and the two lower bolts and attach the bumper to the frame rear cross member. Install the lock washers and nuts. Install the two bolts and nuts with lock washers, attaching the bumper to the frame side member. Attach the tail and signal lamp bracket with the four bolts and nuts through the bracket, the bumper and frame.

(2) **INSTALL GROUND STRAP (IF SO EQUIPPED).** Install a toothed lock washer on the bolt that attaches the ground strap to the bumper and insert the bolt through the bumper bar. Install another toothed lock washer over the end of the bolt and place the ground strap over the bolt. Then install the remaining toothed lock washer over the bolt and install the nut.

g. Removal of Rear Bumper (Carryall). Remove the four cap screws that attach the tail and signal lamp brackets to the frame. Remove the two bolts and nuts attaching the bumper to the side member and remove the four bumper to rear cross member bolts and nuts. Disconnect the ground strap at the bumper.

3/4-TON 4 x 4 TRUCK (DODGE)

h. Installation of Rear Bumper (Carryall). Install the plain washers on the two upper and two lower bolts and attach the bumper to the frame rear cross member. Install the lock washers and nuts. Install the two bolts and nuts with lock washers to attach the bumper to the frame side member. Attach the tail and signal lamp bracket with the four cap screws through the bracket, the bumper and into the frame. Attach ground strap (subpar. f (2) above).

Section XXXVIII

SPRINGS AND SHOCK ABSORBERS

	Paragraph
General description	172
Shackle bolts	173
Spring bolts	174
Spring assemblies	175
Shock absorbers	176

172. GENERAL DESCRIPTION.

a. **Springs.** The chassis springs (fig. 193) are all of the semi-elliptical type. The front end of the front springs and the rear end of the rear springs pivot in shackles to allow for variant lengths of the springs as they are flexed by load or rebound. The rear end of the front springs and the front end of the rear springs are mounted on pivot bolts in rigid brackets on the frame. The driving and braking forces are transmitted from the axles to the frame through this end of the springs.

b. **Types of Springs Used.** Trucks (other than Ambulance) bearing serial number 81623727 or a lower serial number, excepting serial numbers 81607816 through 81619000 were originally equipped with eight-leaf front springs. Trucks (other than Ambulance) bearing serial number 81623728 or a higher serial number and trucks with serial numbers 81607816 through 81689000 were originally equipped with nine-leaf front springs. The spring clips used with the eight-leaf springs are $8\frac{5}{8}$ inches long. The clips used with most of the nine-leaf springs are $8\frac{13}{16}$ inches long. When a front spring is replaced, use springs with the same number of leaves on both sides of the truck. If $8\frac{13}{16}$ inch clips are not available, when installing a nine-leaf spring, use thin toothed lock washers instead of the heavy-duty lock washers used with the $8\frac{5}{8}$ inch clips.

c. **Shock Absorbers.** The hydraulic double-acting shock absorbers control the movement of the frame and body of the vehicle in relation to the wheels and axles. By restricting rapid action of the chassis springs, shock absorbers improve the riding qualities and steering stability of the vehicle.

d. Data.

Springs, front:

Length	39 in.
Width	$1\frac{3}{4}$ in.

Springs, rear:

Length	52 in.
Width	$1\frac{3}{4}$ in.

173. SHACKLE BOLTS.

a. **Removal of Front Spring Shackle Bolts** (fig. 194). Place a jack under the bumper and raise the front of the frame enough to

3/4-TON 4 x 4 TRUCK (DODGE)

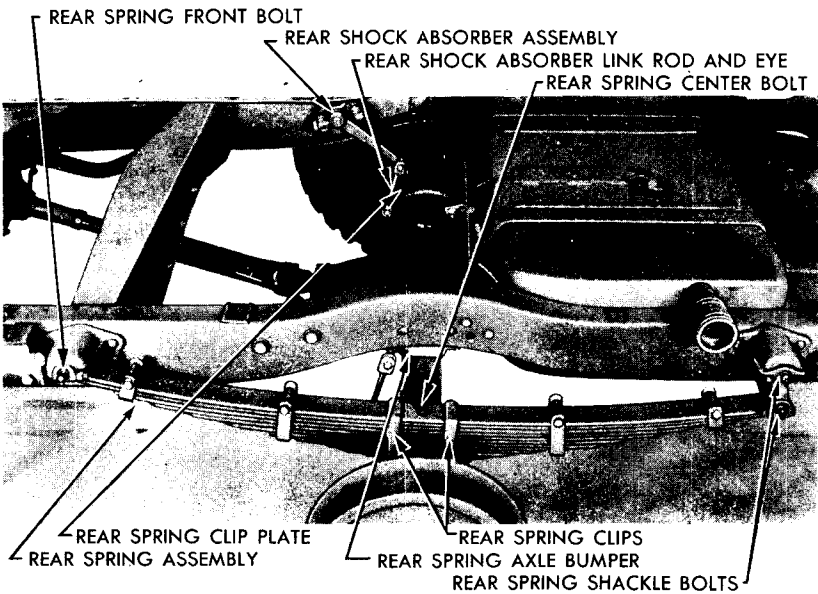
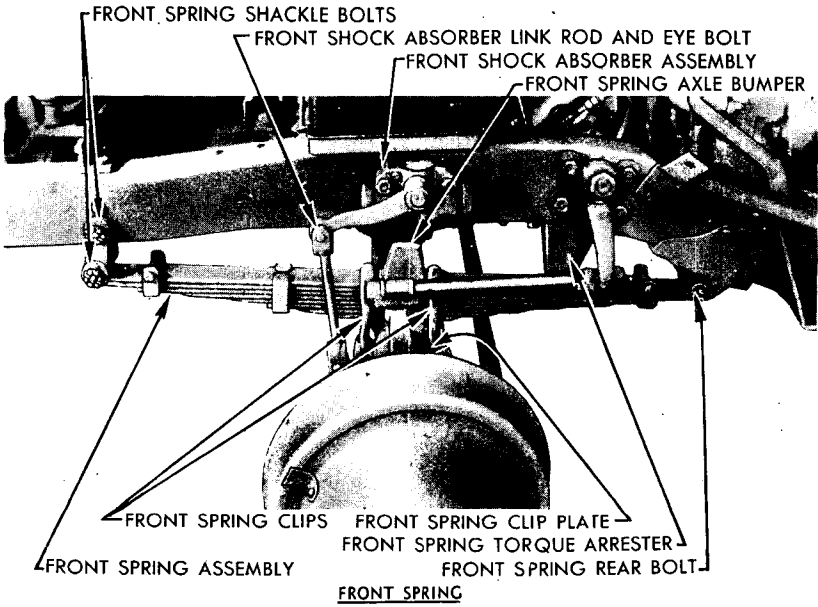

Figure 193—Front and Rear Spring Assemblies

SPRINGS AND SHOCK ABSORBERS

take the load off the shackle bolts. Remove the cotter pins from the slotted nuts at the outer end of the shackle bolts. Remove the slotted nuts and drift out the bolts.

b. Installation of Front Spring Shackle Bolts (fig. 194).

(1) **INSTALL SHACKLE.** Place the offset shackle to the inside of the spring and frame with the long offset up. Install the bolts through the shackle, spring and frame, raising or lowering the jack to aline the holes. Place the straight shackle over the ends of the bolts and install the nuts.

(2) **ADJUST SHACKLE BOLTS.** Tighten the shackle bolt nuts up tight, using a 12-inch wrench, then back each nut off one slot and

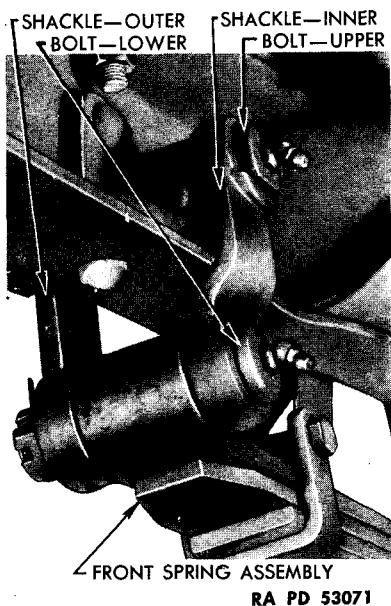

Figure 194—Front Spring Shackle

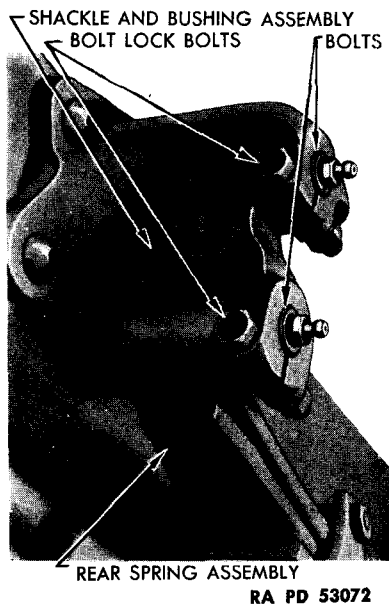

Figure 195—Rear Spring Shackle

install the cotter pins. Do not adjust the bolts tighter than specified. Too tight an adjustment will cause hard riding and spring breakage.

c. Removal of Rear Spring Shackle Bolt (figs. 195 and 199). Remove lubrication fitting from end of bolt. Remove lock bolt from bracket. Insert puller screw through puller barrel from closed end and screw large nut back to head of puller screw. Screw the threaded end of the puller screw tightly into the hole in the spring bolt from which the lubrication fitting was removed. Center the open end of the puller barrel around the end of the spring bolt. Hold the puller screw from turning and screw the large nut against the closed end of the puller barrel to pull the bolt.

3/4-TON 4 x 4 TRUCK (DODGE)

d. **Installation of Rear Spring Shackle Bolt** (fig. 195). Install the spring bolt so that the lock bolt can be installed through the groove in the bolt. Install the lock bolt with standard lock washer and nut. Tighten nut securely. Remove jack from under frame.

174. SPRING BOLTS.

a. **Removal of Front Spring Bolt** (fig. 196). Place jack under front bumper or frame and raise front of frame enough to take load off spring bolt. Remove cotter pin and nut from outer end of spring bolt. Remove the bolt from the bracket and spring eye.

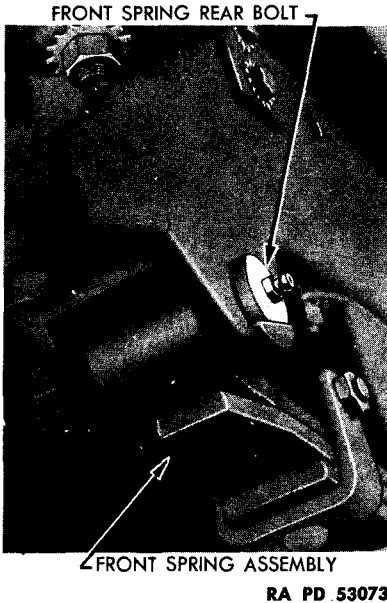

Figure 196—Front Spring Rear Bolt

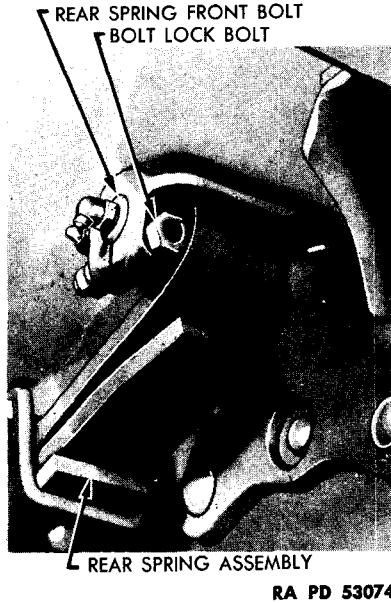

Figure 197—Rear Spring Front Bolt

b. **Installation of Front Spring Bolt** (fig. 196). Insert the spring bolt through the bracket and spring eye from the inside of the bracket. Install the slotted nut on the spring bolt. Tighten the nut up tight, then back it off one slot and install the cotter pin.

c. **Removal of Rear Spring Bolt** (figs. 197 and 198). Remove lubrication fitting from end of bolt. Remove lock bolt from bracket. Insert puller screw through puller barrel from closed end and screw large nut back to head of puller screw. On Command and left side of Carryall, use washers 1/2 inch thick between puller barrel and spring bolt bracket to extend puller out past edge of body. Remove battery to get to bolt on right side of Carryall. Screw the threaded end of the puller screw tightly into the hole in the spring bolt from which the

SPRINGS AND SHOCK ABSORBERS

lubrication fitting was removed. Center the open end of the puller barrel around the end of the spring bolt. Hold the puller screw from turning and screw the large nut against the closed end of the puller barrel to pull the bolt.

d. Installation of Rear Spring Bolt (fig. 197). Install the spring bolt so that the lock bolt can be installed through the groove in the bolt. Install the lock bolt with standard lock washer and nut. Tighten the nut securely. Remove jack from under the frame. Install battery (Carrayall only).



RA PD 53075

Figure 198—Removing Rear Spring Front Bolt with Puller 41-P-2951-70

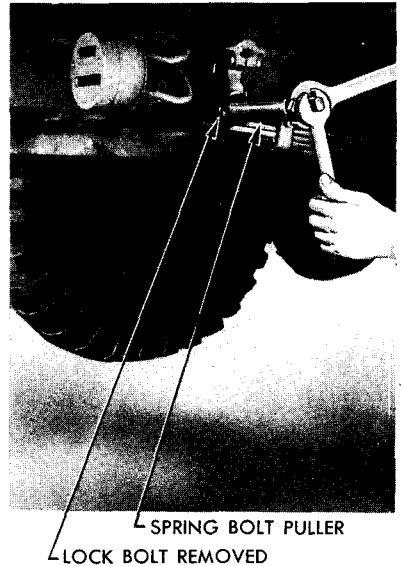

RA PD 53076

Figure 199—Removing Rear Spring Shackle Bolt with Puller 41-P-2951-70

175. SPRING ASSEMBLIES.

a. Removal of Front Spring Assembly. Remove four nuts from spring clips. Drive the clips up and off the spring. Remove spring lower shackle bolt (par. 173 a). Remove spring rear bolt (par. 174 a) and lift out spring assembly.

b. Installation of Front Spring Assembly. Install spring rear bolt (par. 174 b). Install spring lower shackle bolt (par. 173 b). Locate the axle so that when the jack is lowered the spring center bolt will enter the recess in the spring pad of the axle. Place rubber bumper on top of the spring at the center and install the spring clips over the rubber bumper, spring and through the bracket on the axle.

3/4-TON 4 x 4 TRUCK (DODGE)

Remove the jack, then install standard lock washers and nuts on the clips and securely tighten the nuts.

c. Removal of Rear Spring Assembly. Remove the four nuts from the spring clips. Drive the clips up and off the spring. Remove rear spring front bolt (par. 174 c). Remove shackle bolt (par. 173 c) and lift out spring assembly.

d. Installation of Rear Spring Assembly. Install rear spring front bolt (par. 174 d). Install shackle bolt (par. 173 d). Locate the axle so that when the jack is lowered the spring center bolt will enter the recess in the spring pad of the axle. Place the spring clips over the spring and through the bracket on the axle. Remove the jack, then install standard lock washers and nuts on the clips and securely tighten the nuts.



LINK DISCONNECTED FROM PLATE
PUMPING



FILLING RA PD 65951

Figure 200—Filling Shock Absorber with Fluid

176. SHOCK ABSORBERS.

a. Filling Shock Absorber (fig. 200). Use only shock absorber fluid when filling shock absorbers. Do not use other fluids such as ordinary engine oil or brake fluid. Disconnect the link at the lower end (subpar. d below). Wipe off all dirt around the filler plug and remove the plug. Fill the shock absorber to capacity as shown in figure 200. Move the shock absorber arm to the extreme positions several times to pump any air out of the cylinders. Add fluid and repeat the pumping until all air is expelled and the reservoir filled to overflowing. Allow excess fluid to drain out to the level of the

SPRINGS AND SHOCK ABSORBERS

filler plug hole and install the filler plug, using a new gasket. Connect the link assembly (subpar. e below).

b. Removal of Shock Absorber Assembly. Disconnect link from shock absorber arm (subpar. d below). Remove two nuts and bolts which hold shock absorber to the frame and lift off shock absorber.

c. Installation of Shock Absorber. Place the shock absorber in the channel of the frame side rail and insert the bolts through the frame and shock absorber body. Place standard lock washers over the bolts and install the nuts. Connect link to shock absorber arm (subpar. e below).

d. Removal of Shock Absorber Link Assembly. Remove nut from the pin which connects the link to the arm. Remove the pin. Remove nut from pin which connects link to eyebolt at axle. Remove the pin and lift off link assembly.

e. Installation of Shock Absorber Link Assembly. Place the link yoke, with the larger bolt hole, over the eyebolt and bushing at the axle. Install the bolt and nut. Move the yoke at upper end of the link over the bushing in end of shock absorber arm and install bolt and nut.

3/4-TON 4 x 4 TRUCK (DODGE)

Section XXXIX

BODY AND SHEET METAL

	Paragraph
General description	177
Hood	178
Fenders and splash shields	179
Cowl ventilator	180
Windshield assembly (open bodies)	181
Windshield assembly (closed bodies)	182
Windshield wiper assembly (open bodies)	183
Windshield wiper assembly (closed bodies)	184
Body mounting bolts	185
Interchanging bracket positions (Ambulance)	186
Fire extinguisher	187

177. GENERAL DESCRIPTION.

a. The vehicle bodies covered by this section of the manual include all of the types described and illustrated in paragraph 3. Sheet metal units such as rear fenders and running boards vary in design to conform with the different body types. The Carryall and Command are equipped with a 12-volt battery mounted at the rear end of the right running board. Other models are equipped with a 6-volt battery located under the hood. Splash shields between the front fenders and the chassis frame can be removed to make the lower part of the engine more accessible.

178. HOOD.

a. **Removal.** Remove the two screws from the hood hinge front support. Remove the support and tapping plate from the hood hinge. Disconnect the hood to dash ground strap at the dash. Slide the hood forward out of the rear support and remove it from the vehicle.

b. **Installation.** Slide the center hinge rod into the rear support. Slide the front hinge support over the end of the hinge rod, and, with toothed lock washers between the shell and tapping plate, tighten the screws. Place a toothed lock washer on each side of the ground strap. Install the bolt and nut and tighten securely.

179. FENDERS AND SPLASH SHIELDS.

a. Removal of Front Fenders.

(1) REMOVE LIGHTS AND CABLE ASSEMBLIES.

(a) *Right or Left Front Fender.* Slide the rubber insulator off the blackout parking light cable connector located near the terminal block on the front frame cross member. Disconnect the two head-

BODY AND SHEET METAL

light cable wires at the terminal block. Remove the two screws which attach the headlight cable grommet to the fender and release the cables from the clip holding them to the radiator shell, then pull cables away from radiator shell and through opening between shell and fender splash shield. Screw out blackout parking light cable loom end from mounting stud and remove mounting stud nut. Remove blackout parking light and cable assembly. Remove the nut from the headlight mounting stud and remove the headlight and cable assembly.

(b) *Left Front Fender Only.* Disconnect blackout driving light cable wire at the terminal block. Remove the two screws which attach the blackout driving light cable grommet to the fender. Remove the nut from the blackout driving light and remove blackout driving light and cable assembly.

(2) **DISCONNECT FENDER.** Remove the five upper cap screws that attach the fender to the fender splash shield. Remove the three cap screws that attach the fenders to the front support and remove the three cap screws that attach the fender to the rear support.

b. Installation of Front Fender.

(1) **INSTALL FENDER.**

(a) *Right or Left Front Fender.* Place fender in position on front support and install the three rear support to fender cap screws with toothed lock washers. Install the three front support to fender cap screws assembled with toothed lock washers. Install the five upper splash shield to fender cap screws assembled with the special washers.

(b) *Left Front Fender Only.* Assemble the three upper splash shield to fender cap screws with the special washers and cable clips, to the three center screw holes and attach wiring cable under the three clips.

(2) **INSTALL LIGHTS AND CABLE ASSEMBLIES.**

(a) *Right or Left Front Fender.* Install the blackout parking light and cable assembly. Connect cable at connector, then slide rubber insulator over connector to prevent short circuit. Install the headlight and cable assembly. Attach the two wires to the terminal on the terminal block, located on the frame front cross member matching the colors of the wires with those attached to terminal block. Attach the grommet with the two screws.

(b) *Left Front Fender Only.* Install the blackout driving light and cable assembly. Attach the wire to the terminal block matching the color of the wire with the wire attached to terminal block. Attach the grommet with the two screws.

(3) **AIM LIGHTS** (par. 105 or 107).

c. Removal of Rear Fenders.

(1) **RIGHT OR LEFT REAR FENDER.** Remove the bolts which attach the fender to the running board. Remove the cap screws which attach the fender to the body wheel housing.

3/4-TON 4 x 4 TRUCK (DODGE)

(2) **RIGHT REAR FENDER (CARRYALL ONLY).** Remove the cap screw which attaches the battery cover to the running board. Remove the cap screw which attaches the cover to the battery hold-down bracket. Remove the battery hold-down bracket.

d. Installation of Rear Fenders.

(1) **RIGHT OR LEFT REAR FENDER.** Install the cap screws with toothed lock washers which attach the fender to body wheel housing. Install the bolts assembled with toothed lock washers which attach the fender to the running board and install the nuts with toothed lock washer.

(2) **RIGHT REAR FENDER (CARRYALL ONLY).** Install the plain washers between the fender and running board when installing the bolts and nuts which attach the fender to the running board. Install the battery hold-down bracket on fender. Then close the battery cover and install the battery cover hold-down cap screws.

e. Removal of Front Fender Splash Shields. Remove the cap screws which attach the lower sides of the splash shield to the front and rear brackets. Remove the five cap screws which attach the upper side of the splash shield to the fender. Pull out shield under fender.

f. Installation of Front Fender Splash Shields.

(1) **INSTALL RIGHT SPLASH SHIELD.** Place splash shield in position and install the five cap screws with special washers, attaching the upper side of shield to the fender. Install the right front bracket cap screw and both rear bracket cap screws assembled with toothed lock washers.

(2) **INSTALL LEFT SPLASH SHIELD.** Assemble the five upper splash shield to fender cap screws with the special washers and cable clips under the three center screws and attach the wiring cable under the clips. Install the left front bracket cap screw with a toothed lock washer assembled through the ground strap. Install another toothed lock washer on the cap screw and install the cap screw through the front bracket to attach the shield.

180. COWL VENTILATOR.

a. Replacement of Ventilator Lid. Remove the two screws which attach the lid to the lid hinge and the two screws which attach the lid to the linkage and lift off the lid. To install, insert the two screws with lock washers that attach the lid to lid hinge and the two screws with lock washers that attach the lid linkage to lid, but do not tighten until the lid is adjusted (subpar. b below).

b. Adjustment of Ventilator Lid. Loosen the two screws which attach the lid to the hinge and the two screws which attach the lid to the linkage. Close the ventilator in position and hold it tightly centered in the body opening while tightening the lid to hinge screws from underneath the cowl. Then tighten the lid to linkage screws.

c. Replacement of Ventilator Weatherstrip. Remove ventilator lid (subpar. a above), and insert a screwdriver between the ends of

BODY AND SHEET METAL

the weatherstrip. Pull the weatherstrip out of the cowl recess and clean out the recess thoroughly. Coat the recess and contacting surface of weatherstrip with cement and install the weatherstrip in the recess, so the two ends are butted together at the front of the ventilator. Install ventilator lid (subpar. a above) and adjust (subpar. b above).

181. WINDSHIELD ASSEMBLY (OPEN BODIES).

a. Removal.

(1) REMOVE WINDSHIELD WIPERS (par. 183).



RA PD 53080

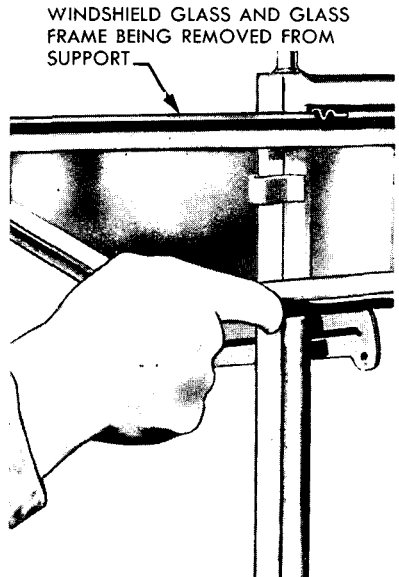

RA PD 53081

Figure 201—Windshield Support (Open Bodies)

Figure 202—Removing Windshield Glass Assembly (Open Bodies)

(2) REMOVE ADJUSTING ARM SCREWS. Remove the screw which attaches the frame to the adjusting arms from the brackets on each side of the frame. Loosen the adjusting arm lock nuts and carefully move the adjusting arms away from the frame bracket and remove the spring washers.

(3) REMOVE WINDSHIELD ASSEMBLY (figs. 201 and 202). Open either end of the windshield support hinge where the hinge is bent over to retain the windshield frame. Disconnect the windshield wiper flexible tube where it attaches to the metal tube across the top of the windshield frame. Open the windshield glass and frame assembly wide and pull the assembly out of the open side of the support hinge.

3/4-TON 4 x 4 TRUCK (DODGE)

b. Installation.

(1) **INSTALL WINDSHIELD ASSEMBLY.** Hold the glass and frame assembly in the fully opened position, with the pull-to handle down and insert the frame hinge flange into the open end of the support hinge, then push the glass and frame assembly all the way into the support hinge.

(2) **ATTACH ADJUSTING ARMS AND LINE UP ASSEMBLY.** Install the spring washers on the windshield frame adjusting arm brackets and attach the arms with the screws. Open and close the glass and frame assembly to line it up and then tighten the adjusting arm lock nuts. Bend the end of the support hinge to close the hinge opening. Connect the windshield wiper flexible tube to the windshield frame metal tube.

(3) **INSTALL WINDSHIELD WIPERS** (par. 183).

182. WINDSHIELD ASSEMBLY (CLOSED BODIES).

a. Removal. Remove windshield wipers (par. 184). Open the windshield wide and remove the six screws which attach the frame to the windshield hinge. Remove the screw which attaches the frame to the adjusting arms from the brackets on each side of the frame. Loosen the adjusting arm lock nuts and carefully move the adjusting arms away from the frame bracket and remove the spring washers. Then lift the frame and glass assembly from the windshield hinges.

b. Installation. Place windshield glass and frame assembly on the hinges and install the six screws to attach the frame and glass to the hinge. Install the spring washers on the windshield frame adjusting arms. Install windshield wipers (par. 184).

c. Adjustment (fig. 203). Close the windshield glass and frame assembly tight in the body opening to determine what adjustment is required. Remove the two header panel cover plates by removing the plate screws. To raise or lower glass and frame assembly in the body opening, loosen the adjusting arm lock nuts and open the glass and frame slightly. Loosen the four screws which attach the body hinges to the glass and frame hinge brackets. Raise or lower the assembly to center it in the opening as required; then tighten the screws. To adjust the glass and frame assembly closer to the body opening, loosen the four hinge cap screws which attach the hinges to the body header brackets. Close the glass and frame assembly and hold it into the opening tightly, while tightening the hinge to body bracket screws. Replace the two header panel cover plates and install plate screws.

183. WINDSHIELD WIPER ASSEMBLY (OPEN BODIES).

a. Removal. Remove the nut that attaches the wiper arm and blade assembly to the motor shaft and remove the arm and blade assembly. Remove the motor mounting nut and the outer spacer. Pull the wiper motor toward the inside of the windshield frame and twist back and forth to release the motor from the flexible tube. Then pull

BODY AND SHEET METAL

the wiper and inner spacer from the windshield frame upper cross-piece.

b. Installation. Install the inner spacer on the wiper motor. Install the motor in the windshield frame upper crosspiece and attach the flexible tube. Install the outer spacer with the spacer flange against the upper crosspiece and install the motor mounting nut. Attach the blade and arm assembly to the motor shaft and move the arm to the right or left as far as it will go. Remove and reset the blade arm if it is not properly centered in the glass.

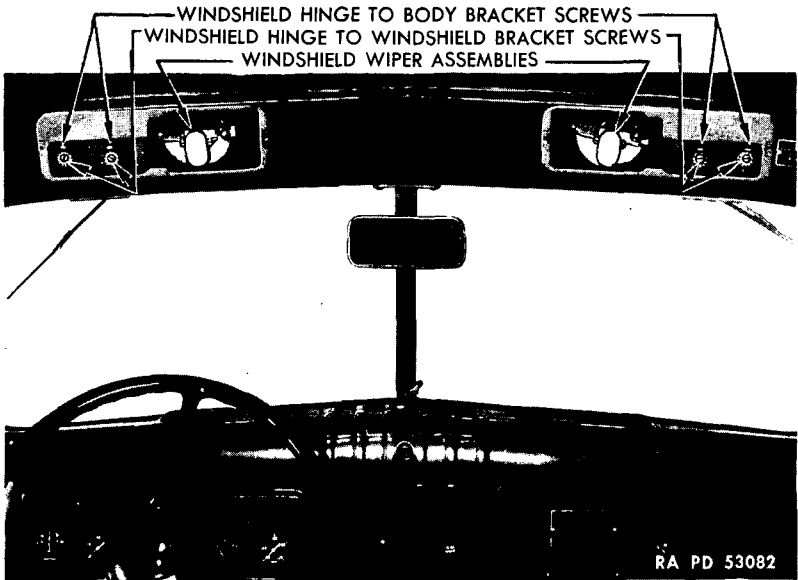

**Figure 203—Windshield Hinge and Wiper Location
(Closed Bodies)**

184. WINDSHIELD WIPER ASSEMBLY (CLOSED BODIES).

a. Removal (fig. 203). Remove the header panel cover plate screws and remove the plate. Remove the nut that attaches the wiper arm and blade assembly to the motor shaft and remove the arm and blade assembly. Remove the motor mounting nut and the outer spacer. Pull the wiper motor toward the inside of the vehicle and release the flexible tube. Remove the inner spacer.

b. Installation. Install the inner spacer over the motor mounting hub. Install the motor in the header opening and attach the flexible tube to the motor. Install the outer spacer over the motor hub and install the mounting nut. Attach the arm and blade assembly to the motor shaft and move the arm to the right or left as far as it will go. Remove and reset the blade arm if it is not properly centered in the glass. Install the header panel cover plate.

¾-TON 4 x 4 TRUCK (DODGE)**185. BODY MOUNTING BOLTS.**

a. **Weapon Carrier, Telephone Maintenance, and Emergency Repair Bodies.** The front section or open cab composing windshield, cowl, and bucket seat assembly is mounted on the frame solidly with a bolt at the left front corner and with spring-loaded bolts at the other three corners. The rear body section of the Weapon Carrier and Telephone Maintenance is solidly mounted to the chassis frame at six points; the Emergency Repair body is mounted solidly to frame at four points.

b. **Carryall, Ambulance, and Command.** The bodies of these vehicles are mounted solidly to the chassis frame as follows:

- (1) Carryall, 10 points.
- (2) Ambulance, 14 points.
- (3) Command, 8 points.

c. **Tightening and Adjusting.** To tighten and adjust open cab mounting bolts, tighten the left front bolt nut securely. Compress the springs of the three spring-loaded bolts to $3\frac{1}{2}$ inches with the bolt nut. Keep the mounting bolts of the body sections which are mounted solidly on frame tightened securely.

**186. INTERCHANGING BRACKET POSITIONS
(AMBULANCE).**

a. In trying to slide two litters on the floor of the Ambulance, interference occurs between the litter legs, and the rear litter strap and the bracket assembly. This is particularly true on the older type wooden litters (the legs on the later type litters have been changed to provide additional side clearance). Because of this interference, it is necessary to lift the litter over the rear floor strap bracket before the litter can be slid into place.

b. To prevent interference between rear floor litter strap brackets and litter legs, interchange the rear floor litter strap brackets and the brackets mounted on top of the locker boxes on the sides of the body. To do this, proceed as follows (fig. 204).

(1) Use same center line for this installation. Drill one $1\frac{1}{32}$ -inch hole in the top of the locker box. This hole should be $7\frac{1}{2}$ inches from the end of the locker, and 1 inch from the outer edge.

(2) Drill two $\frac{7}{32}$ -inch holes in the side of the locker box for the bracket that was on the top of the locker box. These holes should be $2\frac{3}{4}$ inches up from the floor of the vehicle.

(3) Install the strap and brackets in the same manner as shown in figure 204, using the same attaching bolts.

(4) This correction should be performed on both sides of the body in the rear.

187. FIRE EXTINGUISHER.

a. Test the fire extinguisher as explained in paragraph 11. If the extinguisher contains dirty fluid, empty it and refill with one quart

BODY AND SHEET METAL

of underwriter's approved SOS liquid (Specification OF 380) made especially for this type extinguisher. Do not use water or any other chemical intended for other types of fire extinguishers in this extinguisher.

b. To refill, remove filler hole plug and pull handle out to full extent of travel. Pour liquid through filler-hole until extinguisher is full. Install filler hole plug and pump extinguisher plunger up and down once or twice to remove trapped air. Push handle down and lock in position. Remove filler hole plug and add sufficient liquid to fill the extinguisher. Install filler plug and gasket.

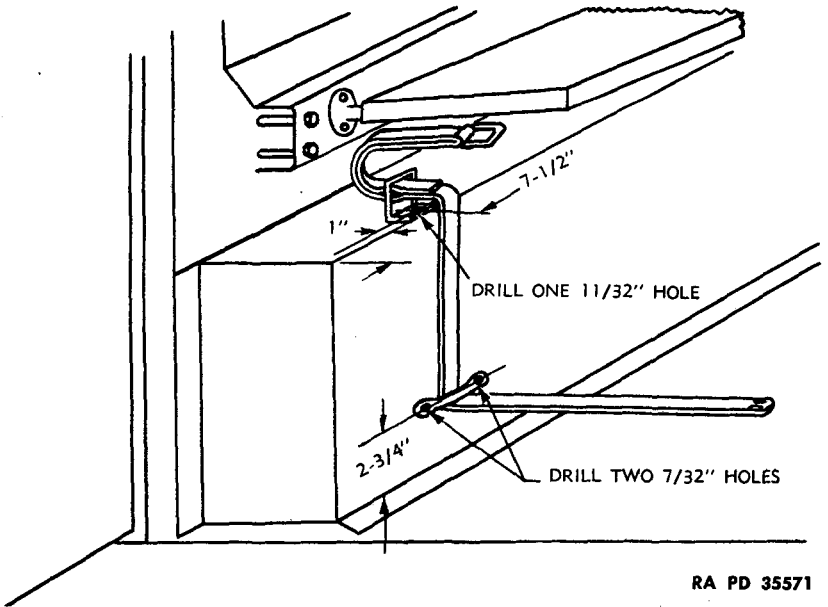

Figure 204—Interchanging Bracket Positions (Ambulance)

c. If the test indicates the fluid is clean, but insufficient in quantity, discharge part of the liquid in the extinguisher and fill to level of lower edge of filler plug opening. Replace plug and tighten securely.

3/4-TON 4 x 4 TRUCK (DODGE)

Section XL

WINCH

	Paragraph
General description	188
Brake adjustments	189
Drum brake shoe and lining	190
Drive joint shear pin	191
Winch drive shaft	192
Winch assembly	193

188. GENERAL DESCRIPTION.

a. A winch is mounted on the front of the Weapon Carrier and Command (models WC-52 and WC-57) and is operated by power

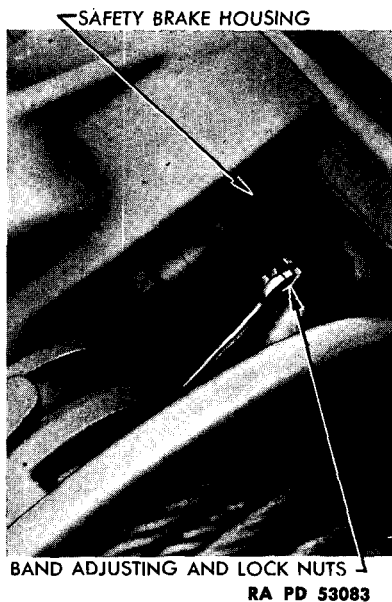

Figure 205—Adjusting Winch Safety Brake



Figure 206—Adjusting Winch Drum Brake

from the engine of the vehicle. The power is transmitted through the vehicle transmission to a power take-off unit, mounted on the side of the transmission case, then through a drive shaft to the winch assembly. Operation of the winch is controlled from the driver's compartment. A shear pin located in the front universal joint of the winch drive shaft is expected to shear off before damage occurs, should the winch be excessively overloaded.

WINCH

189. BRAKE ADJUSTMENTS.

a. **Adjustment of Safety Brake** (fig. 205). If load slips when take-off is in neutral or when shear pin has failed, increase spring tension on brake spring by turning the adjusting nut on underside of brake case clockwise. Tighten $\frac{1}{2}$ turn, then tighten lock nut and test. Tighten more (by $\frac{1}{2}$ turns) if necessary. Even if correctly adjusted, the brake will heat somewhat but if the hand cannot be held on the brake case, the brake adjustment is too tight.

b. **Adjustment of Drum Brake** (fig. 206). If the winch drum spins when the cable is being released, it will be necessary to adjust

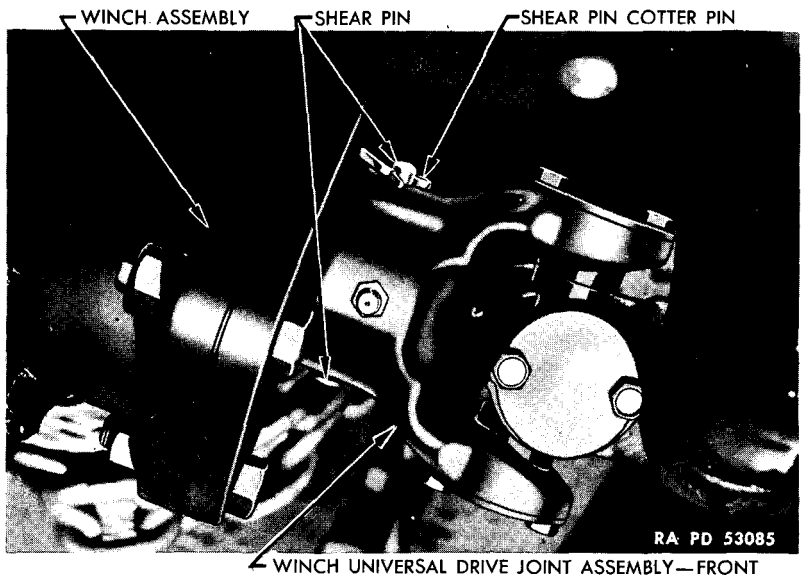

Figure 207—Winch Universal Drive Joint Shear Pin

the brake. The brake shoe link and adjusting nuts are mounted at the inner end of the sliding clutch shifter lever and are accessible for adjustment from the underside of the winch when the sliding clutch is engaged. Loosen the lock nut and turn the adjusting nut to increase tension on the spring to tighten the brake. Reduce the tension on the spring to loosen the brake. When adjustment is completed, hold the adjusting nut and tighten the lock nut.

190. DRUM BRAKE SHOE AND LINING.

a. **Removal.** Remove cotter pin from lower end of the pin around which the sliding clutch shifter lever pivots. Pull the pin out and remove the brake shoe. Remove the rivets which hold the lining to the shoe.

3/4-TON 4 x 4 TRUCK (DODGE)

b. **Installation.** Rivet new lining to the shoe. Install coiled spring over adjustment screw and put the shoe in place. Install the pivot pin through the brake shoe link and the shifter lever. Place cotter pin through lower end of the pivot pin. Adjust drum brake (par. 189).

191. DRIVE JOINT SHEAR PIN.

a. **Removal** (fig. 207). Remove lock wire from set screw in collar at rear end of winch drive shaft. Loosen set screw in the collar and slide the drive shaft universal joint of the winch shaft. Drift broken shear pin out of winch shaft and universal joint.

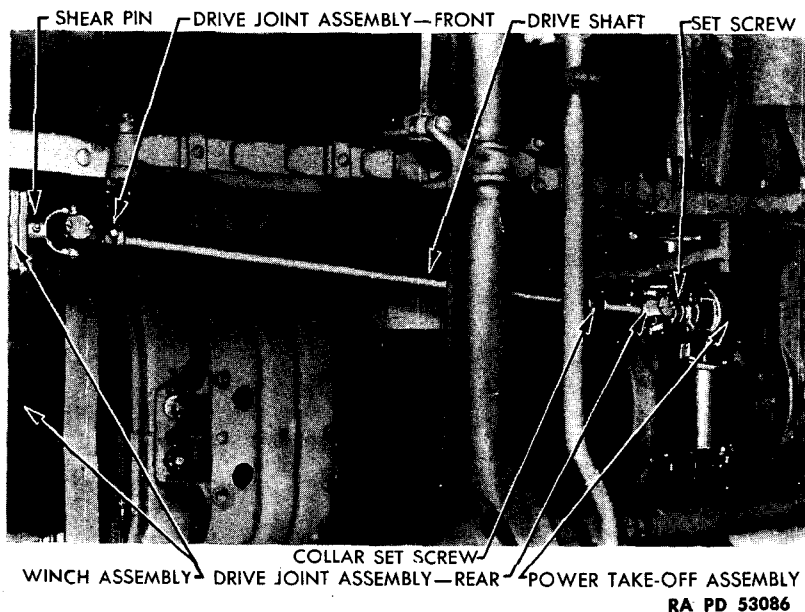

Figure 208—Winch Universal Drive Shaft and Joint

b. **Installation** (fig. 207). Slide the universal joint over the winch shaft with the pin holes in line. Use drift to align holes. Insert shear pin through universal and winch shaft and install cotter pin through end of the shear pin. Slide the collar at the rear end of the drive shaft to $\frac{3}{8}$ to $\frac{1}{2}$ inch from the universal joint yoke on the rear end of the drive shaft. Tighten the set screw and install lock wire.

192. WINCH DRIVE SHAFT.

a. **Removal** (fig. 208). Remove lock wires from set screws in collar at rear end of winch drive shaft and rear universal joint. Loosen set screws and pull the joint off the power take-off shaft. Remove drive shaft shear pin (par. 191) and pull the front universal joint and drive shaft off the winch shaft.

WINCH

b. Installation (fig. 208). Slide the front universal joint yoke over the winch shaft and install the drive shaft shear pin (par. 191). Move the rear universal joint onto the power take-off shaft to $\frac{1}{16}$ inch from the power take-off housing and tighten the set screws; also, slide collar at rear end of drive shaft to $\frac{3}{8}$ to $\frac{1}{2}$ inch from the universal joint yoke and tighten set screws. Install lock wires.

193. WINCH ASSEMBLY.

a. Removal. Remove lock wire from set screw in collar at rear end of the drive shaft. Loosen the set screw. Remove cotter pin from end of the shear pin. Remove the shear pin. Slide the drive shaft universal joint off the end of the winch shaft. Remove six nuts and bolts which hold the winch assembly to the frame. Attach chain or rope from hoist around the left end of the winch drum. Raise winch slightly and swing it to the right enough so that its frame will clear the tow hook on the frame left side rail. Lift the winch assembly out of the chassis frame.

b. Installation. Attach chain or rope from hoist around the left end of the winch drum and hoist the winch above chassis frame and a little to the right of its installed position, so that when it is lowered, its frame will clear the tow hook on the frame left side rail. Lower the winch into the chassis and swing it to the left and into position. Install the six mounting bolts with standard lock washers and nuts. Place the drive shaft universal over end of winch shaft with shear pin holes in line, and align holes. Insert shear pin through the hole and install cotter pin through end of the shear pin. Slide the collar at the rear end of the drive shaft back to within $\frac{3}{8}$ to $\frac{1}{2}$ inch of the rear universal joint yoke, tighten set screw, and install lock wire.

¾-TON 4 x 4 TRUCK (DODGE)**PART THREE—STORAGE AND SHIPMENT****Section XLI****STORAGE AND SHIPMENT**

	Paragraph
Storage and shipment (general)	194
Special precautions for storage	195
Methods of securing vehicle on freight cars	196
Overseas shipment	197
Shipment with combat units	198

194. STORAGE AND SHIPMENT (GENERAL).

a. The ¾-ton truck will usually be shipped uncrated for domestic shipment. For overseas shipment trucks will usually be shipped crated in pairs. Preparation for temporary storage (less than 60 days) will be the same as preparation for domestic shipment, and preparation for indefinite storage (over 60 days) will be the same as the preparation for overseas shipment.

b. Preparation for Domestic Shipment and Temporary Storage.

(1) **LUBRICATION.** Lubricate the vehicle completely before storage or shipment.

(2) **FUEL IN TANKS.** It will not be necessary to remove the fuel from the tanks nor to label these tanks under Interstate Commerce Commission Regulations.

(3) **WATER IN RADIATOR.** Drain the radiator only when there is a possibility of freezing during storage or shipment. If the water is drained from the radiator, tie a conspicuous tag to the steering wheel of each vehicle indicating that the radiator is empty.

(4) **BATTERY.** Disconnect the battery by removing the positive battery cable. Tape the cable and tie it away from the battery.

(5) **UNPAINTED SURFACES.** Treat all unpainted and exposed surfaces with rust-preventive before the vehicle is stored or shipped. After cleaning the surface with solvents or a soap solution, treat all exterior surfaces with a thin film of rust-preventive compound. Apply preventive cold by spraying or brushing. It will harden to a tough thin film. Treat surfaces from which it would be difficult to remove rust-preventives, such as the bore of a gun, with rust-preventive compound, light. Apply this compound by brushing or slushing.

(6) **TIRES.** For domestic shipment, inflate the tires to about 10 pounds above normal.

(7) **INSPECTION.** Make systematic inspection just before shipment or storage. Make a list of all missing items or broken items that are not repaired, and attach the list to the steering wheel.

STORAGE AND SHIPMENT

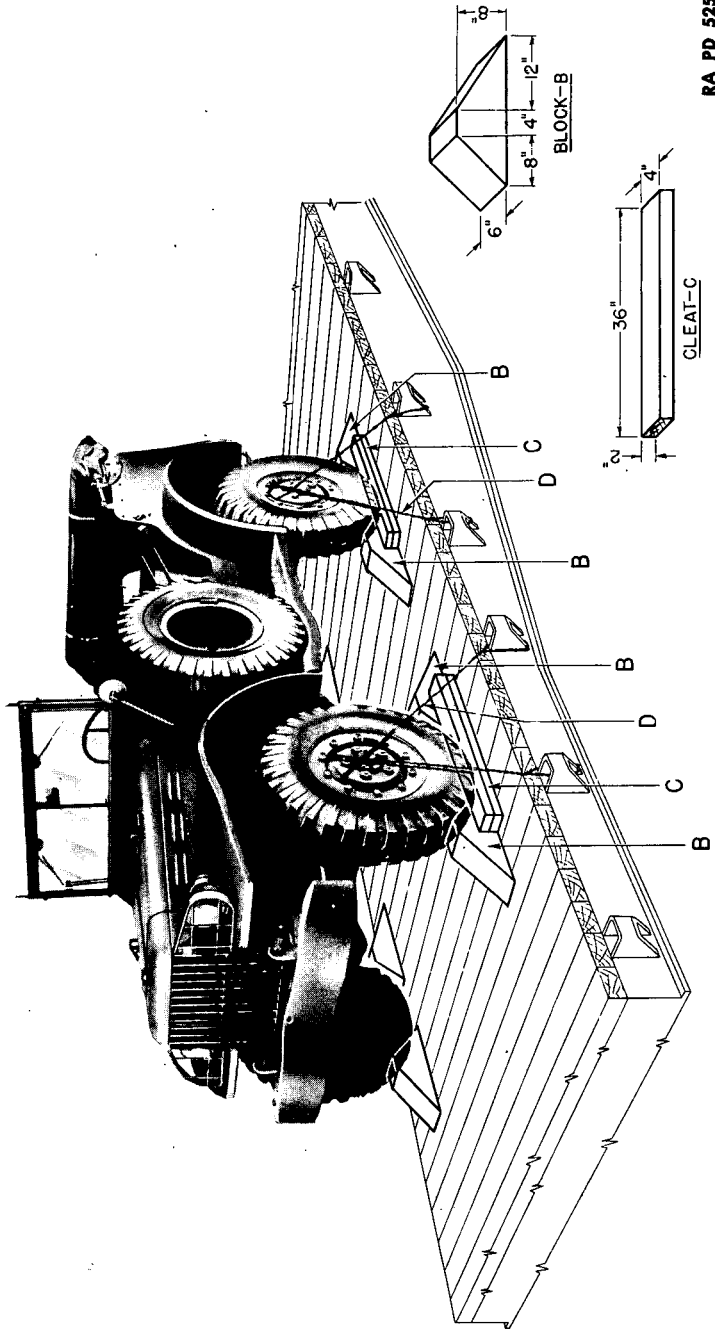

RA PD 52565

Figure 209—Method 1 for Blocking 3/4-Ton 4 x 4 Truck (Dodge) on Freight Cars

3/4-TON 4 x 4 TRUCK (DODGE)

c. **Preparation for Overseas Shipment and Indefinite Storage.** Observe all precautions given in paragraph 194 b in preparation for overseas shipment and indefinite storage. Many additional precautions must be taken, especially for overseas shipment. (See AR 850-18.)

195. SPECIAL PRECAUTIONS FOR STORAGE.

a. Take the following precautions when the truck is prepared for storage.

b. **Engine.**

- (1) Check the engine oil and replenish if necessary.
- (2) Remove the air cleaner from the carburetor.
- (3) Start the engine and run it at a fast idle, spraying approximately one pint of lubricating oil preservative (medium) into the carburetor throat. Turn off the ignition switch immediately after the oil has been sprayed into the carburetor.
- (4) With the ignition switch off, open the throttle wide and turn the engine over several complete revolutions by means of the starting motor.

(5) Install the air cleaner.

c. **Brakes.** Release the brakes and block the wheels.

d. **Inspections.**

- (1) Inspect the vehicles weekly for tire leaks or discharged batteries.
- (2) Upon removal from storage, repair or replace any items noted on the tag attached to the steering wheel as still needing repair or still missing, and perform a complete monthly maintenance inspection.

196. METHODS OF SECURING VEHICLE ON FREIGHT CARS.

a. There are two approved methods of blocking the 3/4-ton trucks on freight cars as described below.

b. **Method I (fig. 209).**

(1) **BLOCKS B.** Place eight blocks B to the front and to the rear of each front wheel and to the front of each forward rear wheel, and to the back of each rearward rear wheel. Nail the heel of the block to the car floor with five 40-penny nails, and toenail that portion of the block under the tire to the car floor with two 40-penny nails. **CAUTION:** *Nail blocks B in such a position that cleats C will clear face of tires by 1/2 inch.*

(2) **CLEATS C.** Place two cleats C against the outside face of blocks B at each front and rear wheel. Nail the lower cleats to the car floor with three 40-penny nails and the top cleat to the cleats below with three 40-penny nails. Fill the 1/2-inch space between tires and cleats C with burlap or other similar material to prevent chafing of tires.

STORAGE AND SHIPMENT

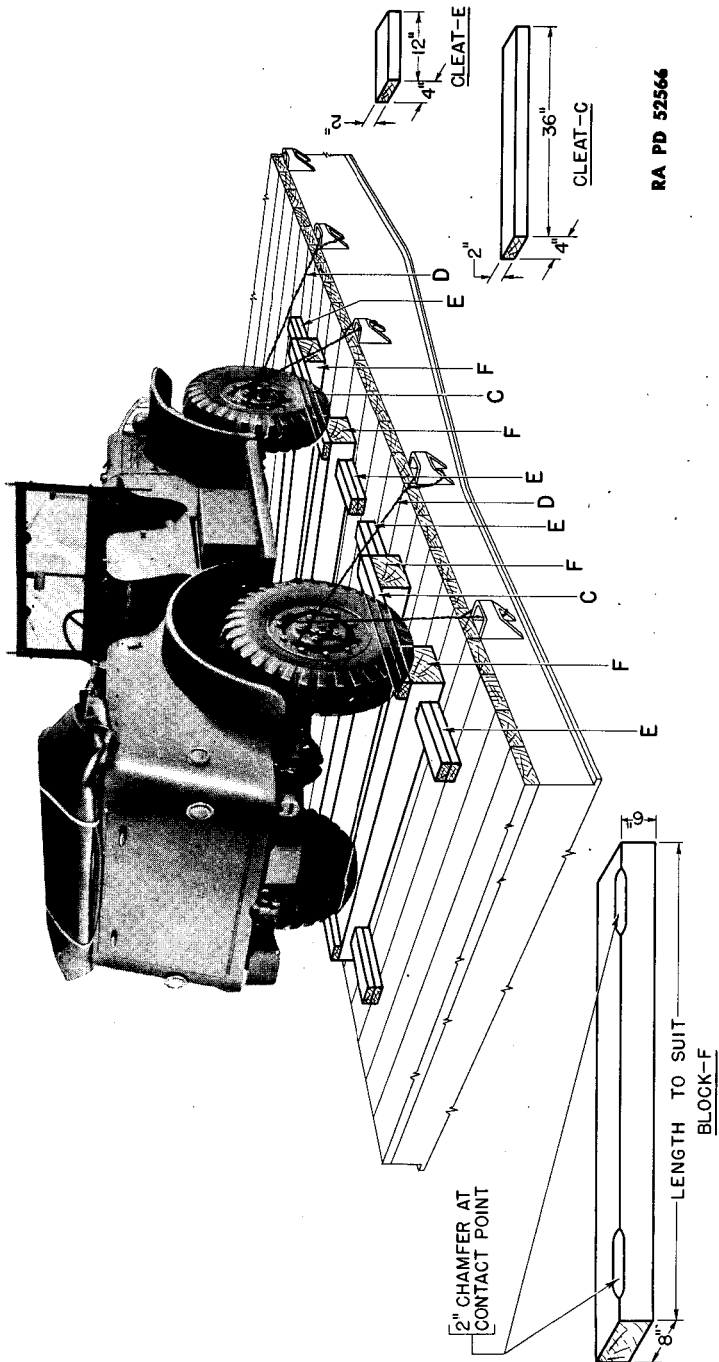

RA PD 52566

Figure 210—Method 2 for Blocking 3/4-Ton 4 x 4 Truck (Dodge) on Freight Cars

3/4-TON 4 x 4 TRUCK (DODGE)

(3) STRAPPING D. Pass four strands, two wrappings, of No. 8 gage, black annealed wire (D, fig. 209) through the spokes of the wheels and the stake pockets. Tighten the wires enough to remove slack. If a box car is used, apply this strapping in similar fashion and attach it to the floor by the use of blocking or anchor plates. This strapping is not required when gondola cars are used.

c. Method 2 (fig. 210).

(1) BLOCKS F. Place one block F across the front and one across the rear of the front wheels. Place one block F to the front of the forward rear wheels and one block F to the rear of the rearward rear wheels. These blocks must be at least eight inches wider than the over-all width of the vehicle at the car floor.

(2) CLEATS E. Place sixteen cleats E against blocks F, as shown in figure 210.

(3) CLEATS C. Wrap cleats C with burlap or other similar material to prevent chafing of tires. Place one cleat C against the outside of each front wheel on the top of block F, as shown in figure 210. Nail the cleats to each block F with two 40-penny nails.

(4) STRAPPING D. Pass four strands, two wrappings, of No. 8 gage, black annealed wire (D, fig. 210) through the spokes of the wheels and the stake pockets. Tighten the wires enough to remove slack. If a box car is used, apply this strapping in similar fashion and attach it to the floor by the use of blocking or anchor plates. This strapping is not required when gondola cars are used.

197. OVERSEAS SHIPMENT.

a. The truck will usually be crated for overseas shipment to protect the truck, to reduce cubic measurement, and to facilitate stowage. Usually this crate will be made up as a twin pack; that is, containing two vehicles broken down as much as necessary in order to save cubic displacement. When such crating is necessary, it should be performed in accordance with IOSSC-(a), "Introduction to Ordnance Storage and Shipment Chart, Section (a), Instructions and Specifications for Packaging Ordnance General Supplies."

198. SHIPMENT WITH COMBAT UNITS.

a. Shipping of Vehicles, Combat Loaded.

(1) Do not disassemble the vehicle. Protect unpainted surfaces with lubricating oil preservative.

(2) BLOCKING. Whenever possible, use blocking similar to that shown in figures 212 and 213. However, special precautions must be taken to prevent the materiel from moving sideways.

b. Protection During Shipping.

(1) MATERIALS AVAILABLE. Keep a supply of the required cleaning and preserving materials available for servicing while in transit.

(2) DECK LOADS. When the materiel is shipped on deck, cover the vehicle with a closely fitting tarpaulin. Seal all engine openings, such as the carburetor, air intake, exhaust outlet, oil breather outlet,

STORAGE AND SHIPMENT

etc., with waterproof tape. Apply this sealing so that it is easily accessible without disassembly in order that the vehicle may be ready for immediate action.

c. **Inspections.** Make daily inspections for signs of corrosion which should be checked immediately by reapplication of rust-preventives and lubricating oil. Do not allow salt water to dry on unprotected surfaces under any circumstances. If possible, after the materiel has been subjected to salt water flush the materiel with clean, fresh water.

3/4-TON 4 x 4 TRUCK (DODGE)**REFERENCES****PUBLICATIONS INDEXES.**

The following publications indexes should be consulted frequently for latest changes or revisions to the publications given in this list of references and for new publications relating to materiel covered in this manual:

Ordnance publications for supply index (index to SNL's)	ASF Cat. ORD-2 OPSI
Index to Ordnance publications (lists FM's, TM's, TC's, and TB's of interest to Ordnance personnel, FSMWO's, BSD, S of SR's, OSSC's and OFSB's. Includes alphabetical listing of Ordnance major items with publications pertaining thereto)	OFSB 1-1
List of publications for training (lists MR's, MTP's, T/BA's, T/A's, FM's, TM's, and TR's, concerning training)	FM 21-6
List of training films, film strips, and film bulletins (lists TF's, FS's, and FB's by serial number and subject)	FM 21-7
Military training aids (lists graphic training aids, models, devices, and displays)	FM 21-8

STANDARD NOMENCLATURE LISTS.

3/4-ton 4 x 4 truck (Dodge)	SNL G-502
Cleaning, preserving, and lubricating materials; recoil fluids, special oils, and miscellaneous related items	SNL K-1
Interchangeability chart of organization tools for Ordnance vehicles	SNL G-19
Soldering, brazing, and welding materials, gases, and related items	SNL K-2
Tool sets (motor transport)	SNL N-19

EXPLANATORY PUBLICATIONS.**Fundamental Principles.**

Automotive brakes	TM 10-565
Automotive electricity	TM 10-580
Automotive lubrication	TM 10-540
Automotive power transmission units	TM 10-585
Basic Maintenance Manual	TM 38-250
Chassis, body, and trailer units	TM 10-560
Desert operation	FM 31-25
Driver's manual	TM 10-460
Electrical fundamentals	TM 1-455

REFERENCES

Fuels and carburetion	TM 10-550
Military motor vehicles	AR 850-15
Motor transport	FM 25-10
Motor vehicle inspections and preventive maintenance services	TM 9-2810
Operations in snow and extreme cold	FM 31-15
Precautions in handling gasoline	AR 850-20
Sheet metal work, body, fender, and radiator repairs	TM 10-450
Standard military motor vehicles	TM 9-2800
The internal combustion engine	TM 10-570
The motor vehicle	TM 10-510

Maintenance and Repair.

Cleaning, preserving, lubricating, and welding materials, and similar items issued by the Ordnance Department	TM 9-850
Cold weather lubrication and service of combat vehicles and automotive materiel	OFSB 6-11
Maintenance and care of pneumatic tires and rubber treads	TM 31-200
Ordnance maintenance: Carburetors (Zenith) ..	TM 9-1826C
Ordnance maintenance: Electrical equipment (Auto-Lite)	TM 9-1825B
Ordnance maintenance: Electrical equipment (Delco-Remy)	TM 9-1825A
Ordnance maintenance: Fuel pumps	TM 9-1828A
Ordnance maintenance: Hydraulic brake system (Wagner)	TM 9-1827C
Ordnance maintenance: Power plant, clutch, and electrical systems for basic vehicles, 3/4-ton 4 x 4, and 1 1/2-ton 6 x 6 (Dodge)	TM 9-1808A
Ordnance maintenance: Power train, chassis, and body for basic vehicles, 3/4-ton 4 x 4, and 1 1/2-ton 6 x 6 (Dodge)	TM 9-1808B
Ordnance maintenance: Speedometers and tachometers (Stewart-Warner)	TM 9-1829A
Tune-up and adjustment	TM 10-530

Protection of Materiel.

Camouflage	FM 5-20
Chemical decontamination, materials and equipment	TM 3-220
Decontamination of armored force vehicles ...	FM 17-59

3/4-TON 4 x 4 TRUCK (DODGE)

Defense against chemical attack FM 21-40
Explosives and demolitions FM 5-25

Storage and Shipment.

Ordnance storage and shipment chart, group G
major items OSSC-G
Registration of motor vehicles AR 850-10
Rules governing the loading of mechanized and
motorized army equipment, also, major cali-
ber guns, for the United States Army and
Navy, on open top equipment published by
Operations and Maintenance Department of
Association of American Railroads.
Storage of motor vehicle equipment..... AR 850-18

INDEX

A	Page No.		Page No.
Auxiliary equipment controls and operation		interchanging bracket positions (Ambulance)	332
fire extinguishers		windshield assembly (closed bodies)	
care	38	adjustment	330
fire classifications	38	installation	330
location	37	removal	330
operation	38	windshield assembly (open bodies)	
test	38	installation	330
winch controls		removal	329
general	34	windshield wiper assembly (closed bodies)	
to hook on	35	installation	331
to pull	36	removal	331
to reverse winch operation	36	windshield wiper assembly (open bodies)	
winch controls	34	installation	331
winding cable on drum	37	removal	330
Axles			
front	268	Brakes	
rear	281	foot	287
		hand	298
		C	
B		Carburetor	168
Battery		Clutch	
battery		clutch disk and release bearing	
battery tests	191	cleaning of parts	254
electrolyte level	191	installation	254
installation	192	removal	254
removal	192	clutch pedal	
temperature at which battery will freeze	192	adjustment	252
battery ground cable		description	252
installation	193	general description	252
removal	193	Cooling system	
battery to cranking motor cable		fan belt	
installation	194	adjustment	181
removal	193	replacement	181
general description		general description	
battery location	191	general	179
data	191	radiator cap	180
thermostat control		thermostat control	179
battery location	191	hose replacement	182
data	191	maintenance	
Body and sheet metal		draining	180
body mounting bolts		filling	180
tightening and adjusting	332	flushing	180
cowl ventilator		radiator	187
adjustment of ventilator lid	328	thermostat	
replacement of ventilator lid	328	installation	182
replacement of ventilator weatherstrip	328	testing	182
fenders and splash shields	326		
fire extinguisher	332		
general description	326		
hood			
installation	326		
removal	326		

3/4-TON 4 x 4 TRUCK (DODGE)

C—Cont'd

Page No.

Page No.

Cooling system—Cont'd
 water pump and fan
 installation (vehicles with fan shroud) 186
 installation (vehicles without fan shroud) 185
 removal (vehicles with fan shroud) 186
 removal (vehicles without fan shroud) 183

D

Data, tabulated
 battery 191
 engine 133
 fuel system 165
 ignition system 203
 springs and shock absorbers 319
 vehicle 12

Description of vehicles

data
 capacities 14
 performance 13
 vehicle specifications 12

description 6

differences among models

Ambulance (Model WC-54) 10
 Carryall (Model WC-53) 7
 Command (Models WC-56 and WC-57) 10
 Emergency Repair (Model WC-60) 10
 Telephone Maintenance (Model WC-59) 10
 Weapon Carrier (Models WC-51 and WC-52) 7

Driving controls and operation

body equipment
 installation of tarpaulin (Weapon Carrier) 33
 lowering folding top (Command) 29
 raising folding top (Command) 30
 removal of tarpaulin (Weapon Carrier) 33
 side curtains (Command) 32
 windshield 29
 instruments and controls 15
 preparation of new vehicle for service 22

towing the vehicle
 pintle hook 28
 tow hooks 27
 towing precautions 28
 towing vehicle to start engine 28
 use of instruments and controls in vehicular operation
 “breaking-in” speeds 27
 driving in four-wheel drive 25
 driving the vehicle 24
 driving up or down steep grades 26
 maximum permissible road speeds 27
 reversing 25
 starting the engine 23
 starting the engine after running out of fuel 24
 stopping the engine 27
 stopping the vehicle 27

E

Engine—description, maintenance, and adjustment in vehicle

breather pipe air cleaner 151
 crankcase ventilator 152
 cylinder head gasket
 cleaning and inspection 141
 installation 141
 removal 140
 description and tabulated data
 engine numbers 133
 general description 133
 tabulated data 133
 engine tune-up 134
 installation 158
 manifold heat control valve 137
 manifolds and gaskets
 installation 143
 removal 142
 oil filter
 cleaning 149
 installation of cartridge 149
 installation of oil filter assembly 149
 removal of cartridge 149
 removal of oil filter assembly 149
 oil pan
 cleaning 145
 installation 145
 removal 145

INDEX

E—Cont'd	Page No.	Page No.
Engine—description, maintenance, and adjustment in vehicle— Cont'd		
oil pressure relief valve and oil pump		
cleaning and inspection	146	
installation of oil pump	148	
installation of relief valve	146	
removal of oil pump	146	
removal of relief valve	146	
oil tubes (external)		
installation	150	
removal	150	
repair	150	
removal	154	
valves and springs		
installation	139	
removal	138	
Exhaust system		
exhaust pipe		
installation	177	
removal	177	
general description	177	
muffler		
installation	177	
removal	177	
tail pipe		
installation	177	
removal	177	
F		
First echelon preventive maintenance services		
after-operation and weekly service procedures	53	
at-halt service procedures	51	
before-operation service procedures	48	
during-operation service procedures	50	
purpose	47	
Foot brakes		
bleeding brake system		
using hydraulic brake filler	291	
without use of hydraulic filler tank	293	
brake adjustments	287	
adjustment of brake pedal free travel	290	
major brake adjustment	287	
minor brake adjustment	287	
brake shoes, linings, and drums		
cleaning and inspection of brakes	293	
installation of brake shoes	294	
removal of brake shoes	294	
general description	287	
master cylinder		
installation	296	
removal	296	
wheel cylinders		
installation	295	
removal	295	
Frame		
bumpers	316	
general description	316	
Front axle		
front axle assembly		
cleaning front axle housing vent	278	
differential and carrier assembly installation	279	
differential and carrier assembly removal	278	
installation	280	
removal	279	
front wheel alignment		
checking and adjusting toe-in	269	
front wheel turning radius	270	
general	268	
front wheel bearings		
adjustment	270	
front wheel bearings and oil seal installation	272	
front wheel bearings and oil seal removal	271	
general description	268	
steering arm and tie rod		
steering arm installation	278	
steering arm removal	278	
steering tie rod installation	278	
steering tie rod removal	278	
universal drive shaft, bushings, and oil seals		
adjustment of steering knuckle flange bearings	276	
cleaning and inspection of universal drive assembly	274	
installation	276	
removal	273	

3/4-TON 4 x 4 TRUCK (DODGE)

F—Cont'd	Page No.		Page No.
Fuel system		removal of tank to fuel filter	
air cleaner		tube (rear section)	174
air cleaner assembly		repairing	175
installation	165	general description	
air cleaner assembly removal . .	165	data, tabulated	165
filter element installation	165	fuel gage	165
filter element removal	165	fuel system	163
carburetor and governor			
adjustment of governor on			
engine	166		
carburetor assembly			
installation	170		
carburetor assembly removal . .	168		
choke control wire installation .	171		
choke control wire removal . . .	170		
throttle control wire			
installation	171		
throttle control wire removal .	171		
throttle stop screw and			
idling adjustment	166		
fuel filter			
cleaning of filter element	174		
draining of filter	174		
fuel filter assembly installation .	174		
fuel filter assembly removal . . .	174		
fuel gage			
instrument panel unit			
installation	172		
instrument panel unit removal .	171		
tank unit installation	172		
tank unit removal	172		
fuel pump			
cleaning of strainer bowl			
and screen	172		
fuel pump assembly installation	173		
fuel pump assembly removal . . .	173		
fuel tank			
installation	171		
removal	171		
fuel tube lengths	176		
fuel tubes			
installation of fuel filter to fuel			
pump tube	175		
installation of tank to fuel filter			
tube (front section)	175		
installation of tank to fuel filter			
tube (rear section)	174		
removal of fuel filter to fuel			
pump tube	175		
removal of tank to fuel filter			
tube (front section)	174		
		G	
		Generating system	
		general description	
		generating circuit	199
		types used	198
		voltage regulation	198
		generator (6-volt)	
		installation	199
		removal	199
		generator (12-volt)	
		installation	200
		removal	200
		generator regulator	
		installation	201
		removal	201
		H	
		Hand brake	
		band and lining	
		installation	300
		removal	300
		general description	298
		hand brake adjustment	
		procedure	298
		hand brake and linkage	
		hand brake rod adjustment and	
		installation	301
		hand brake rod removal	301
		lever installation	301
		lever removal	301
		hand brake drum	
		installation	301
		removal	301
		I	
		Ignition system	
		condenser	
		installation	206
		removal	206
		distributor assembly	
		installation	207
		removal	206
		distributor (breaker points)	
		adjustment	205
		installation	205
		removal	205

INDEX

I—Cont'd	Page No.		Page No.
Ignition system—Cont'd		oil gage	
distributor cap		installation	233
installation	206	removal	233
removal	206	roof ventilator (Ambulance)	
distributor rotor		replacement of switch	238
installation	206	roof ventilator assembly	
removal	206	installation	238
general description		roof ventilator assembly	
data	203	removal	238
ignition coil and switch		speedometer	
coil installation	208	cable installation	235
coil removal	207	cable removal	235
switch installation	208	head installation	235
switch removal	208	head removal	234
ignition timing		thermometer	
checking timing with timing		installation	234
light	204	removal	233
timing specifications	203	trailer connector	
spark plugs		installation	239
adjustment	204	removal	239
installation	204	voltmeter (Command and Carryall)	
spark plug cables		installation	232
installation	204	removal	232
removal	204	replacement of voltmeter switch	233
Instruments, gages, and miscellaneous electrical equipment		Introduction to manual	
ammeter		scope of manual	5
installation	231		
removal	231	L	
general description		Lighting system	
heater	231	blackout driving light and switch	
horn	231	aiming of blackout driving light	225
instruments and gages	231	blackout driving light assembly	
trailer connector	231	installation	225
heater (Ambulance)		blackout driving light assembly	
defroster assembly installation	237	removal	224
defroster assembly removal	237	blackout driving light switch	
defroster switch installation	237	installation	224
defroster switch removal	237	blackout driving light switch	
heater assembly installation	237	removal	224
heater assembly removal	237	sealed beam unit installation	224
heater switch installation	237	sealed beam unit removal	224
heater switch removal	237	blackout parking lights	
horn		parking light assembly	
adjustment	236	installation	224
horn button and wire		parking light assembly removal	224
installation	237	replacement of lamp	224
horn button and wire removal	236	dome lights	
installation	236	dome light assembly	
removal	236	replacement (Ambulance)	227
		dome light assembly	
		replacement (Carryall)	227

3/4-TON 4 x 4 TRUCK (DODGE)

L—Cont'd	Page No.	Page No.	
Lighting system—Cont'd			
dome light—Cont'd			
dome light switch replacement	227	run-in test procedures	
lamp replacement	227	preliminary service	71
general description	220	O	
headlight beam indicator and switch		Operation under unusual conditions	
control switch	223	cold weather operation	
headlight beam indicator		antifreeze	42
assembly installation	223	antifreeze table	42
headlight beam indicator		chassis lubricants	41
assembly removal	223	engine lubrication	40
replacement of headlight beam	223	gasoline for low temperatures	40
replacement of lamp	223	general	39
headlights		general conditions	44
assembly and installation	221	other lubrication points	43
headlight aiming	222	protection of electrical system	43
removal and disassembly	221	starting and operation	44
sealed beam lamp-unit		stopping	44
installation	221	transmission, transfer case	
sealed beam lamp-unit		and differentials	41
removal	221	decontamination	46
instrument lights and switch		flood and submersion	
instrument light socket		emergency procedure	45
replacement	227	general	45
instrument light switch		general	39
replacement	226	hot weather operation	
lamp replacement	226	cooling system	45
main lighting and blackout switch		fuel and exhaust systems	45
circuit breaker installation	230	ignition system	45
circuit breaker removal	230	lubrication attention	44
switch assembly removal	229	manifold heat control	45
switch installation	230	operation in sand, deep mud,	
spotlight (Ambulance)		and slippery terrain	39
lamp replacement	227	Organization tools and equipment	
spotlight assembly installation	228	special tools	98
spotlight assembly removal	228	standard tools and equipment	98
tail and stop lights		P	
sealed beam unit replacement	226	Propeller shafts	
stop light switch replacement	226	general description	265
tail and stop light assembly		installation	267
replacement	226	removal	265
Lubrication		R	
introduction	57	Radio interference suppression	
Lubrication Guide		general	209
lubrication notes	57	servicing and replacing bonded	
reports and records	67	parts	219
supplies	57	Rear axle	
N		general description	281
New vehicle run-in test		rear axle assembly	
introduction		cleaning rear axle housing vent	284
correction of deficiencies	71	differential and carrier	
		assembly installation	285

INDEX

R—Cont'd	Page No.		Page No.
Rear axle—Cont'd		removal	196
rear axle assembly—Cont'd		cranking motor pedal	
differential and carrier		installation	196
assembly removal	285	removal	196
rear axle assembly installation	285	cranking motor switch	
rear axle assembly removal	285	installation	196
rear axle drive shafts		removal	195
installation	284	general description	195
removal	283	Steering	
rear wheel bearings		drag link	
adjustment of rear wheel		adjustment	314
bearings	281	assembly and installation	315
inner oil seal and bearings		inspection	315
installation	282	removal and disassembly	315
inner oil seal and bearings		general description	310
removal	282	steering gear	
outer oil seal installation	282	adjustment of steering gear in	
outer oil seal removal	282	vehicle	310
Record of modifications		installation of steering wheel ..	314
MWO and major unit		removal of steering wheel	313
replacement record		steering gear (Pitman) arm	
description	70	installation	314
early modifications	70	removal	314
instructions for use	70	Storage and shipment	
References		method of securing vehicle on	
explanatory publications		freight cars	340
fundamental principles	344	overseas shipment	342
maintenance and repair	345	shipment with combat units	
protection of materiel	345	inspections	343
storage and shipment	346	protection during shipping	342
publications indexes	344	shipping of vehicles, combat	
standard nomenclature lists	344	loaded	342
S		special precautions for storage	
Second echelon preventive		brakes	340
maintenance services		engine	340
road test chart	81	inspections	340
maintenance operations	83	storage and shipment (general)	
tools and equipment	96	preparation for domestic ship-	
Springs and shock absorbers		ment and temporary storage ..	338
general description		preparation for overseas ship-	
data	319	ment and indefinite storage ..	340
shock absorbers	319	T	
springs	319	Tires (and wheels)	303.
types of springs used	319	Tools and equipment stowage on the	
shackle bolts	319	vehicle	
shock absorbers	324	vehicle tools and equipment	
spring assemblies	323	care of tools and equipment ..	69
spring bolts	322	pioneer equipment	69
Starting system		spare parts kit	68
cranking motor		vehicle tools	68
installation	197		

3/4-TON 4 x 4 TRUCK (DODGE)

T—Cont'd	Page No.		Page No.
Transfer case		tire casing and tube	
control lever and linkage		inspection.....	306
installation.....	263	installation.....	306
linkage adjustment.....	263	removal.....	306
removal.....	262	tire inflation and care	
general description.....	262	care of tires.....	304
transfer case assembly		tire inflation.....	303
installation.....	264	wheel and tire assembly	
misalignment.....	263	installation.....	306
removal.....	263	removal.....	304
Transmission and power take-off		Winch	
general description.....	256	brake adjustments	
power take-off control linkage		adjustment of brake drum.....	335
control lever installation.....	260	adjustment of safety brake.....	335
control lever linkage adjustment.....	261	drive joint shear pin	
control lever removal.....	260	installation.....	336
transmission		removal.....	336
installation.....	256	drum brake shoe and lining	
removal.....	256	installation.....	336
Trouble shooting		removal.....	335
battery and generating system... 108		general description.....	334
cooling system.....	105	winch assembly	
clutch.....	124	installation.....	337
engine.....	99	removal.....	337
exhaust system.....	105	winch drive shaft	
foot brakes.....	128	installation.....	337
front and rear axles.....	127	removal.....	336
fuel system.....	104	Wiring	
hand brake.....	129	body wiring assembly (filter to	
ignition system.....	107	instrument panel)	
instruments, gages, horn, heater		description.....	249
and roof ventilator.....	120	installation.....	249
introduction.....	99	removal.....	249
lighting system.....	118	description	
propeller shafts.....	126	general.....	241
radio interference suppression.... 122		wiring assemblies.....	241
springs and shock absorbers..... 131		words "right" and "left".....	245
starting system.....	106	generator to regulator wiring	
steering.....	130	assembly	
transfer case.....	126	installation.....	251
transmission.....	125	removal.....	251
wheels and tires.....	130	lower wiring assembly (junction	
winch.....	132	block to lights)	
		description.....	247
W		installation.....	247
Wheels and tires		removal.....	247
general description.....	303	upper wiring assembly (junction	
spare wheel and tire assembly		block to instrument panel)	
installation.....	306	description.....	248
removal.....	306	installation.....	248
		removal.....	248